



***supermagnete***

***Catalogue***

***supermagnete.ch***

## Dear Customer

We offer you the strongest magnets in many shapes and sizes. Nearly all of our magnets are made of Neodymium Iron Boron (NdFeB). These are the strongest permanent magnets in existence. They are many times stronger than typical magnets.

You have to experience these magnets yourself in order to understand why they are called "super magnets".

This catalogue displays the same articles that are available in our web shop. You can find more detailed information and additional photos in the item descriptions at [www.supermagnete.ch](http://www.supermagnete.ch). We have made every effort to simplify the order process for you.

I hope you enjoy your shopping experience!

Marion Zollinger, Chief Executive Officer

## Our Mailing Address (not a store!):

[supermagnete.ch](http://supermagnete.ch)

Webcraft AG

Weiherallee 11a

8610 Uster

Switzerland

Tel. +41 43 399 03 59

[support@supermagnete.ch](mailto:support@supermagnete.ch)

### Validity of product pricing

The product prices shown here match the shop prices effective on 28.05.2022. We strive to provide a high degree of price stability but are subject to market-based price fluctuations which can be attributed to trends in raw material pricing or currency fluctuations, for instance. For information on current prices, we recommend you look them up in the shop under [www.supermagnete.ch](http://www.supermagnete.ch) or call our customer service at +41 43 399 03 59.

## Magnet systems with hooks

<b>BD-FTNG-22</b> magnet system Ø 22 mm black rubber-coated with hook (hook magnet) thread M4 Weight: 16 g strength: approx. 5.9 kg	Price in CHF 1 pc. 4.20 ea. from 3 pcs. 3.75 ea. from 10 pcs. 3.35 ea. from 20 pcs. 3.20 ea. from 40 pcs. 3.00 ea.	Pot diameter D: 22 mm Neck diameter d: 8 mm Pot height H1: 6 mm Total height without hook H2: 11.5 mm Total height with hook H3: 26.1 mm Thread M: 4
<b>BD-FTNG-31</b> magnet system Ø 31 mm black rubber-coated with hook (hook magnet) thread M4 Weight: 25 g strength: approx. 9 kg	Price in CHF 1 pc. 4.85 ea. from 3 pcs. 4.25 ea. from 10 pcs. 3.75 ea. from 20 pcs. 3.50 ea. from 40 pcs. 3.30 ea.	Pot diameter D: 31 mm Neck diameter d: 7 mm Pot height H1: 6 mm Total height without hook H2: 11.5 mm Total height with hook H3: 26 mm Thread M: 4
<b>BD-FTNG-43</b> magnet system Ø 43 mm black rubber-coated with hook (hook magnet) thread M4 Weight: 33 g strength: approx. 10 kg	Price in CHF 1 pc. 5.85 ea. from 3 pcs. 5.20 ea. from 10 pcs. 4.60 ea. from 20 pcs. 4.30 ea. from 40 pcs. 4.05 ea.	Pot diameter D: 43 mm Neck diameter d: 8 mm Pot height H1: 6 mm Total height without hook H2: 10.5 mm Total height with hook H3: 24.5 mm Thread M: 4
<b>BD-FTNG-66</b> magnet system Ø 66 mm black rubber-coated with hook (hook magnet) thread M5 Weight: 110 g strength: approx. 25 kg	Price in CHF 1 pc. 9.00 ea. from 3 pcs. 7.95 ea. from 10 pcs. 7.05 ea. from 20 pcs. 6.60 ea. from 40 pcs. 6.20 ea.	Pot diameter D: 66 mm Neck diameter d: 10 mm Pot height H1: 8.5 mm Total height without hook H2: 15 mm Total height with hook H3: 44 mm Thread M: 5
<b>BD-FTNG-88</b> magnet system Ø 88 mm black rubber-coated with hook (hook magnet) thread M8 Weight: 230 g strength: approx. 56 kg	Price in CHF 1 pc. 13.55 ea. from 3 pcs. 12.15 ea. from 10 pcs. 10.90 ea. from 20 pcs. 10.30 ea. from 40 pcs. 9.75 ea.	Pot diameter D: 88 mm Neck diameter d: 12 mm Pot height H1: 8.5 mm Total height without hook H2: 17 mm Total height with hook H3: 60.1 mm Thread M: 8
<b>BD-FTNGW-22</b> magnet system Ø 22 mm white rubber-coated with hook (hook magnet) thread M4 Weight: 16 g strength: approx. 5.9 kg	Price in CHF 1 pc. 4.20 ea. from 3 pcs. 3.75 ea. from 10 pcs. 3.35 ea. from 20 pcs. 3.20 ea. from 40 pcs. 3.00 ea.	Pot diameter D: 22 mm Neck diameter d: 8 mm Pot height H1: 6 mm Total height without hook H2: 11.5 mm Total height with hook H3: 26.1 mm Thread M: 4
<b>BD-FTNGW-31</b> magnet system Ø 31 mm white rubber-coated with hook (hook magnet) thread M4 Weight: 25 g strength: approx. 9 kg	Price in CHF 1 pc. 4.85 ea. from 3 pcs. 4.25 ea. from 10 pcs. 3.75 ea. from 20 pcs. 3.50 ea. from 40 pcs. 3.30 ea.	Pot diameter D: 31 mm Neck diameter d: 7 mm Pot height H1: 6 mm Total height without hook H2: 11.5 mm Total height with hook H3: 26 mm Thread M: 4
<b>BD-FTNGW-43</b> magnet system Ø 43 mm white rubber-coated with hook (hook magnet) thread M4 Weight: 33 g strength: approx. 10 kg	Price in CHF 1 pc. 5.85 ea. from 3 pcs. 5.20 ea. from 10 pcs. 4.60 ea. from 20 pcs. 4.30 ea. from 40 pcs. 4.05 ea.	Pot diameter D: 43 mm Neck diameter d: 8 mm Pot height H1: 6 mm Total height without hook H2: 10.5 mm Total height with hook H3: 24.5 mm Thread M: 4

<b>BD-FTNGW-66</b> magnet system Ø 66 mm white rubber-coated with hook (hook magnet) thread M5 Weight: 110 g strength: approx. 25 kg		Price in CHF	Pot diameter D: 66 mm Neck diameter d: 10 mm Pot height H1: 8.5 mm Total height without hook H2: 15 mm Total height with hook H3: 44 mm Thread M: 5
		1 pc. 9.00 ea.	
	from	3 pcs. 7.95 ea.	
	from	10 pcs. 7.05 ea.	
	from	20 pcs. 6.60 ea.	
	from	40 pcs. 6.20 ea.	
<b>BD-FTNGW-88</b> magnet system Ø 88 mm white rubber-coated with hook (hook magnet) thread M8 Weight: 230 g strength: approx. 56 kg		Price in CHF	Pot diameter D: 88 mm Neck diameter d: 12 mm Pot height H1: 8.5 mm Total height without hook H2: 17 mm Total height with hook H3: 60.1 mm Thread M: 8
		1 pc. 13.55 ea.	
	from	3 pcs. 12.15 ea.	
	from	10 pcs. 10.90 ea.	
	from	20 pcs. 10.30 ea.	
	from	40 pcs. 9.75 ea.	

## Magnet systems with eyelets

<p><b>BD-OTNG-22</b> magnet system Ø 22 mm black rubber-coated with eyelet (eyelet magnet) thread M4 Weight: 16 g/set strength: approx. 5.9 kg</p>	<p>Price in CHF</p> <p>1 set 4.00/set from 3 sets 3.55/set from 10 sets 3.15/set from 20 sets 3.00/set from 40 sets 2.80/set</p>	<p>Pot diameter D: 22 mm Neck diameter d: 8 mm Pot height H1: 6 mm Total height without eyelet H2: 11.5 mm Total height with eyelet H3: 26.5 mm Thread M: 4</p>
<p><b>BD-OTNG-31</b> magnet system Ø 31 mm black rubber-coated with eyelet (eyelet magnet) thread M4 Weight: 25 g/set strength: approx. 9 kg</p>	<p>Price in CHF</p> <p>1 set 4.65/set from 3 sets 4.05/set from 10 sets 3.55/set from 20 sets 3.30/set from 40 sets 3.10/set</p>	<p>Pot diameter D: 31 mm Neck diameter d: 7 mm Pot height H1: 6 mm Total height without eyelet H2: 11.5 mm Total height with eyelet H3: 25.5 mm Thread M: 4</p>
<p><b>BD-OTNG-43</b> magnet system Ø 43 mm black rubber-coated with eyelet (eyelet magnet) thread M4 Weight: 33 g/set strength: approx. 10 kg</p>	<p>Price in CHF</p> <p>1 set 5.65/set from 3 sets 5.00/set from 10 sets 4.40/set from 20 sets 4.10/set from 40 sets 3.85/set</p>	<p>Pot diameter D: 43 mm Neck diameter d: 8 mm Pot height H1: 6 mm Total height without eyelet H2: 10.5 mm Total height with eyelet H3: 24 mm Thread M: 4</p>
<p><b>BD-OTNG-66</b> magnet system Ø 66 mm black rubber-coated with eyelet (eyelet magnet) thread M5 Weight: 110 g/set strength: approx. 25 kg</p>	<p>Price in CHF</p> <p>1 set 9.00/set from 3 sets 7.95/set from 10 sets 7.05/set from 20 sets 6.60/set from 40 sets 6.20/set</p>	<p>Pot diameter D: 66 mm Neck diameter d: 10 mm Pot height H1: 8.5 mm Total height without eyelet H2: 15 mm Total height with eyelet H3: 43.5 mm Thread M: 5</p>
<p><b>BD-OTNG-88</b> magnet system Ø 88 mm black rubber-coated with eyelet (eyelet magnet) thread M8 Weight: 250 g/set strength: approx. 56 kg</p>	<p>Price in CHF</p> <p>1 set 14.95/set from 3 sets 13.55/set from 10 sets 12.30/set from 20 sets 11.70/set from 40 sets 11.15/set</p>	<p>Pot diameter D: 88 mm Neck diameter d: 12 mm Pot height H1: 8.5 mm Total height without eyelet H2: 17 mm Total height with eyelet H3: 53.2 mm Thread M: 8</p>
<p><b>BD-OTNGW-22</b> magnet system Ø 22 mm white rubber-coated with eyelet (eyelet magnet) thread M4 Weight: 16 g/set strength: approx. 5.9 kg</p>	<p>Price in CHF</p> <p>1 set 4.00/set from 3 sets 3.55/set from 10 sets 3.15/set from 20 sets 3.00/set from 40 sets 2.80/set</p>	<p>Pot diameter D: 22 mm Neck diameter d: 8 mm Pot height H1: 6 mm Total height without eyelet H2: 11.5 mm Total height with eyelet H3: 26.5 mm Thread M: 4</p>
<p><b>BD-OTNGW-31</b> magnet system Ø 31 mm white rubber-coated with eyelet (eyelet magnet) thread M4 Weight: 25 g/set strength: approx. 9 kg</p>	<p>Price in CHF</p> <p>1 set 4.65/set from 3 sets 4.05/set from 10 sets 3.55/set from 20 sets 3.30/set from 40 sets 3.10/set</p>	<p>Pot diameter D: 31 mm Neck diameter d: 7 mm Pot height H1: 6 mm Total height without eyelet H2: 11.5 mm Total height with eyelet H3: 25.5 mm Thread M: 4</p>
<p><b>BD-OTNGW-43</b> magnet system Ø 43 mm white rubber-coated with eyelet (eyelet magnet) thread M4 Weight: 33 g/set strength: approx. 10 kg</p>	<p>Price in CHF</p> <p>1 set 5.65/set from 3 sets 5.00/set from 10 sets 4.40/set from 20 sets 4.10/set from 40 sets 3.85/set</p>	<p>Pot diameter D: 43 mm Neck diameter d: 8 mm Pot height H1: 6 mm Total height without eyelet H2: 10.5 mm Total height with eyelet H3: 24 mm Thread M: 4</p>

<b>BD-OTNGW-66</b> magnet system Ø 66 mm white rubber-coated with eyelet (eyelet magnet) thread M5 Weight: 110 g/set strength: approx. 25 kg		Price in CHF	Pot diameter D: 66 mm Neck diameter d: 10 mm Pot height H1: 8.5 mm Total height without eyelet H2: 15 mm Total height with eyelet H3: 43.5 mm Thread M: 5
		1 set 9.00/set	
	from	3 sets 7.95/set	
	from	10 sets 7.05/set	
	from	20 sets 6.60/set	
	from	40 sets 6.20/set	
<b>BD-OTNGW-88</b> magnet system Ø 88 mm white rubber-coated with eyelet (eyelet magnet) thread M8 Weight: 250 g/set strength: approx. 56 kg		Price in CHF	Pot diameter D: 88 mm Neck diameter d: 12 mm Pot height H1: 8.5 mm Total height without eyelet H2: 17 mm Total height with eyelet H3: 53.2 mm Thread M: 8
		1 set 14.95/set	
	from	3 sets 13.55/set	
	from	10 sets 12.30/set	
	from	20 sets 11.70/set	
	from	40 sets 11.15/set	

## Cable ties

<p><b>CAT-01</b> Plastic cable ties 200 x 5.00 mm locking head set of 20 in different colours Weight: 1 g</p>	<p>Price in CHF 20 pcs. 0.15 ea.</p>	<p>These practical cable ties are not only suitable for bundling or securing cables and wires. You can also use cable ties in a variety of ways around the home, workshop or camper.</p>
<p><b>CAT-02</b> Plastic cable ties 400 x 5.00 mm locking head set of 20 in different colours Weight: 38 g</p>	<p>Price in CHF 20 pcs. 0.30 ea.</p>	<p>Bye-bye cable clutter! You can keep things tidy with these standard cable ties in black or white.</p>
<p><b>CAT-04</b> Self-gripping cable tie 'Wrap It' flexible hook and loop fastener with eyelet reusable set of 6, black Weight: 24 g/set</p>	<p>Price in CHF 1 set 13.00/set from 10 sets 12.85/set from 20 sets 12.30/set from 40 sets 11.80/set</p>	<p>These self-gripping cable ties are particularly suitable for sensitive cables. The advantages at a glance: double-sided hook and loop fastener, reusable, easy to remove, durable, can be shortened if necessary.</p>
<p><b>CAT-05</b> Rubber cable ties 'T-Fix' 6 cm reusable set of 50 black Weight: 2.5 g</p>	<p>Price in CHF 50 pcs. 0.25 ea.</p>	<p>Rubber cable ties are particularly popular for temporarily attaching cable bundles, e.g. to stage structures or exhibition stands. You can also use them to quickly secure other small items.</p>
<p><b>CAT-06</b> Rubber cable ties 'T-Fix' 16 cm reusable set of 50 black Weight: 5 g</p>	<p>Price in CHF 50 pcs. 0.50 ea.</p>	<p>The advantages of the 'T-Fix' rubber cable ties at a glance: durable, reusable, easy and versatile use, no traces of glue on cables.</p>
<p><b>CAT-07</b> Stainless steel cable tie 260 x 4.6 mm ball lock 1 piece Weight: 3.5 g</p>	<p>Price in CHF 1 pc. 1.20 ea.</p>	<p>These wide stainless steel cable ties with a length of 26 cm even hold pipes and larger cables together. Resistant to environmental factors such as heat, cold, chemicals and UV radiation.</p>
<p><b>CAT-08</b> Stainless steel cable tie 680 x 7.90 mm ball lock 1 piece Weight: 12 g</p>	<p>Price in CHF 1 pc. 3.65 ea.</p>	<p>These wide stainless steel cable ties with a length of 68 cm even hold larger pipes and equipment assemblies together. Resistant to environmental factors such as heat, cold, chemicals and UV radiation.</p>
<p><b>CAT-09</b> Plastic cable ties 280 x 4.80 mm locking head set of 100 in different colours Weight: 190 g/set</p>	<p>Price in CHF 1 set 8.75/set</p>	<p>Bye-bye cable clutter! You can keep things tidy with these 28 cm long black or natural-coloured standard cable ties.</p>

**CAT-10**

Plastic cable ties 100 x  
2.50 mm  
locking head  
set of 100  
in different colours  
Weight: 32 g/set

Price in CHF  
1 set 1.00/set

Bye-bye cable clutter! You can keep things tidy with these  
10 cm long black or natural-coloured standard cable ties.

**CAT-11**

Plastic cable ties 540 x  
7.60 mm  
locking head  
set of 100  
in different colours  
Weight: 700 g/set

Price in CHF  
1 set 44.75/set

Bye-bye cable clutter! You can keep things tidy with these  
54 cm long black or natural-coloured standard cable ties.



## Magnet systems with threaded studs

<p><b>GTNG-22</b> magnet system Ø 22 mm black rubber-coated with threaded stud thread M4 Weight: 10 g strength: approx. 5.9 kg</p>	<p>Price in CHF</p> <p>1 pc. 3.75 ea. from 3 pcs. 3.30 ea. from 10 pcs. 2.85 ea. from 20 pcs. 2.65 ea. from 40 pcs. 2.50 ea.</p>	<p>The rubber coating protects delicate surfaces from scratches, increases the weight capacity in shear direction, and makes them slip-resistant.</p>
<p><b>GTNG-31</b> magnet system Ø 31 mm black rubber-coated with threaded stud thread M5 Weight: 21 g strength: approx. 8 kg</p>	<p>Price in CHF</p> <p>1 pc. 3.80 ea. from 3 pcs. 3.35 ea. from 10 pcs. 2.90 ea. from 20 pcs. 2.70 ea. from 40 pcs. 2.55 ea.</p>	<p>The rubber coating protects delicate surfaces from scratches, increases the weight capacity in shear direction, and makes them slip-resistant.</p>
<p><b>GTNG-43</b> magnet system Ø 43 mm black rubber-coated with threaded stud thread M4 Weight: 30 g strength: approx. 10 kg</p>	<p>Price in CHF</p> <p>1 pc. 4.55 ea. from 3 pcs. 4.00 ea. from 10 pcs. 3.45 ea. from 20 pcs. 3.20 ea. from 40 pcs. 3.00 ea.</p>	<p>The rubber coating protects delicate surfaces from scratches, increases the weight capacity in shear direction, and makes them slip-resistant.</p>
<p><b>GTNG-66</b> magnet system Ø 66 mm black rubber-coated with threaded stud thread M8 Weight: 110 g strength: approx. 25 kg</p>	<p>Price in CHF</p> <p>1 pc. 8.45 ea. from 3 pcs. 7.40 ea. from 10 pcs. 6.50 ea. from 20 pcs. 6.05 ea. from 40 pcs. 5.65 ea.</p>	<p>The rubber coating protects delicate surfaces from scratches, increases the weight capacity in shear direction, and makes them slip-resistant.</p>
<p><b>GTNG-88</b> magnet system Ø 88 mm black rubber-coated with threaded stud thread M8 Weight: 190 g strength: approx. 56 kg</p>	<p>Price in CHF</p> <p>1 pc. 14.35 ea. from 3 pcs. 12.85 ea. from 10 pcs. 11.50 ea. from 20 pcs. 10.85 ea. from 40 pcs. 10.30 ea.</p>	<p>The rubber coating protects delicate surfaces from scratches, increases the weight capacity in shear direction, and makes them slip-resistant.</p>
<p><b>GTNGW-22</b> magnet system Ø 22 mm white rubber-coated with threaded stud thread M4 Weight: 10 g strength: approx. 5.9 kg</p>	<p>Price in CHF</p> <p>1 pc. 3.75 ea. from 5 pcs. 3.30 ea. from 15 pcs. 2.85 ea. from 40 pcs. 2.65 ea. from 80 pcs. 2.50 ea.</p>	<p>Pot diameter D: 22 mm Pot height H1: 6 mm Total height H2: 12.5 mm Thread M: 4 Tolerance: +/- 0.5 mm Covering: Rubber (TPV)</p>
<p><b>GTNGW-31</b> magnet system Ø 31 mm white rubber-coated with threaded stud thread M5 Weight: 21 g strength: approx. 8 kg</p>	<p>Price in CHF</p> <p>1 pc. 3.80 ea. from 3 pcs. 3.35 ea. from 10 pcs. 2.90 ea. from 20 pcs. 2.70 ea. from 40 pcs. 2.55 ea.</p>	<p>The white rubber coating protects delicate surfaces from scratches, increases the weight capacity in shear direction, and makes them slip-resistant.</p>
<p><b>GTNGW-43</b> magnet system Ø 43 mm white rubber-coated with threaded stud thread M4 Weight: 30 g strength: approx. 10 kg</p>	<p>Price in CHF</p> <p>1 pc. 4.55 ea. from 3 pcs. 4.00 ea. from 10 pcs. 3.45 ea. from 20 pcs. 3.20 ea. from 40 pcs. 3.00 ea.</p>	<p>Pot diameter D: 43 mm Pot height H1: 6 mm Total height H2: 12 mm Thread M: 4 Tolerance: +/- 0.5 mm Covering: Rubber (TPV)</p>

<b>GTNGW-66</b> magnet system Ø 66 mm white rubber-coated with threaded stud thread M8 Weight: 110 g strength: approx. 25 kg		Price in CHF	Pot diameter D: 66 mm	
		1 pc.	8.45 ea.	
	from	3 pcs.	7.40 ea.	Pot height H1: 8.5 mm
	from	10 pcs.	6.50 ea.	Total height H2: 23.5 mm
	from	20 pcs.	6.05 ea.	Thread M: 8
	from	40 pcs.	5.65 ea.	Tolerance: +/- 0.5 mm
			Covering: Rubber (TPV)	
<b>GTNGW-88</b> magnet system Ø 88 mm white rubber-coated with threaded stud thread M8 Weight: 190 g strength: approx. 56 kg		Price in CHF	Pot diameter D: 88 mm	
		1 pc.	14.35 ea.	
	from	3 pcs.	12.85 ea.	Pot height H1: 8.5 mm
	from	10 pcs.	11.50 ea.	Total height H2: 23.5 mm
	from	20 pcs.	10.85 ea.	Thread M: 8
	from	40 pcs.	10.30 ea.	Tolerance: +/- 0.5 mm
			Covering: Rubber (TPV)	

## Magnet systems with screw sockets

<p><b>TCNG-22</b> magnet system Ø 22 mm black rubber-coated with screw socket thread M4 Weight: 13 g strength: approx. 5.9 kg</p>	<p>Price in CHF</p> <p>1 pc. 3.70 ea. from 3 pcs. 3.25 ea. from 10 pcs. 2.85 ea. from 20 pcs. 2.70 ea. from 40 pcs. 2.50 ea.</p>	<p>Pot diameter D: 22 mm Neck diameter d1: 8 mm Pot height H1: 6 mm Total height H2: 11.5 mm Thread M: 4 Tolerance: +/- 0.5 mm</p>
<p><b>TCNG-31</b> magnet system Ø 31 mm black rubber-coated with screw socket thread M4 Weight: 22 g strength: approx. 8 kg</p>	<p>Price in CHF</p> <p>1 pc. 4.35 ea. from 3 pcs. 3.75 ea. from 10 pcs. 3.25 ea. from 20 pcs. 3.00 ea. from 40 pcs. 2.80 ea.</p>	<p>Pot diameter D: 31 mm Neck diameter d1: 7 mm Pot height H1: 6 mm Total height H2: 11.5 mm Thread M: 4 Tolerance: +/- 0.5 mm</p>
<p><b>TCNG-43</b> magnet system Ø 43 mm black rubber-coated with screw socket thread M4 Weight: 30 g strength: approx. 10 kg</p>	<p>Price in CHF</p> <p>1 pc. 5.35 ea. from 3 pcs. 4.70 ea. from 10 pcs. 4.10 ea. from 20 pcs. 3.80 ea. from 40 pcs. 3.55 ea.</p>	<p>Pot diameter D: 43 mm Neck diameter d1: 8 mm Pot height H1: 6 mm Total height H2: 10.5 mm Thread M: 4 Tolerance: +/- 0.5 mm</p>
<p><b>TCNG-66</b> magnet system Ø 66 mm black rubber-coated with screw socket thread M5 Weight: 110 g strength: approx. 25 kg</p>	<p>Price in CHF</p> <p>1 pc. 8.10 ea. from 3 pcs. 7.05 ea. from 10 pcs. 6.15 ea. from 20 pcs. 5.70 ea. from 40 pcs. 5.30 ea.</p>	<p>Pot diameter D: 66 mm Neck diameter d1: 10 mm Pot height H1: 8.5 mm Total height H2: 15 mm Thread M: 5 Tolerance: +/- 0.5 mm</p>
<p><b>TCNG-88</b> magnet system Ø 88 mm black rubber-coated with screw socket thread M8 Weight: 190 g strength: approx. 56 kg</p>	<p>Price in CHF</p> <p>1 pc. 12.45 ea. from 3 pcs. 11.05 ea. from 10 pcs. 9.80 ea. from 20 pcs. 9.20 ea. from 40 pcs. 8.65 ea.</p>	<p>Pot diameter D: 88 mm Neck diameter d1: 12 mm Pot height H1: 8.5 mm Total height H2: 17 mm Thread M: 8 Tolerance: +/- 0.5 mm</p>
<p><b>TCNGW-22</b> magnet system Ø 22 mm white rubber-coated with screw socket thread M4 Weight: 13 g strength: approx. 5.9 kg</p>	<p>Price in CHF</p> <p>1 pc. 3.70 ea. from 3 pcs. 3.25 ea. from 10 pcs. 2.85 ea. from 20 pcs. 2.70 ea. from 40 pcs. 2.50 ea.</p>	<p>Pot diameter D: 22 mm Neck diameter d1: 8 mm Pot height H1: 6 mm Total height H2: 11.5 mm Thread M: 4 Tolerance: +/- 0.5 mm</p>
<p><b>TCNGW-31</b> magnet system Ø 31 mm white rubber-coated with screw socket thread M4 Weight: 22 g strength: approx. 8 kg</p>	<p>Price in CHF</p> <p>1 pc. 4.35 ea. from 3 pcs. 3.75 ea. from 10 pcs. 3.25 ea. from 20 pcs. 3.00 ea. from 40 pcs. 2.80 ea.</p>	<p>Pot diameter D: 31 mm Neck diameter d1: 7 mm Pot height H1: 6 mm Total height H2: 11.5 mm Thread M: 4 Tolerance: +/- 0.5 mm</p>
<p><b>TCNGW-43</b> magnet system Ø 43 mm white rubber-coated with screw socket thread M4 Weight: 30 g strength: approx. 10 kg</p>	<p>Price in CHF</p> <p>1 pc. 5.35 ea. from 3 pcs. 4.70 ea. from 10 pcs. 4.10 ea. from 20 pcs. 3.80 ea. from 40 pcs. 3.55 ea.</p>	<p>Pot diameter D: 43 mm Neck diameter d1: 8 mm Pot height H1: 6 mm Total height H2: 10.5 mm Thread M: 4 Tolerance: +/- 0.5 mm</p>

<b>TCNGW-66</b> magnet system Ø 66 mm white rubber-coated with screw socket thread M5 Weight: 110 g strength: approx. 25 kg		Price in CHF	Pot diameter D: 66 mm	
		1 pc.	8.10 ea.	
	from	3 pcs.	7.05 ea.	Neck diameter d1: 10 mm
	from	10 pcs.	6.15 ea.	Pot height H1: 8.5 mm
	from	20 pcs.	5.70 ea.	Total height H2: 15 mm
	from	40 pcs.	5.30 ea.	Thread M: 5
			Tolerance: +/- 0.5 mm	
<b>TCNGW-88</b> magnet system Ø 88 mm white rubber-coated with screw socket thread M8 Weight: 190 g strength: approx. 56 kg		Price in CHF	Pot diameter D: 88 mm	
		1 pc.	12.45 ea.	
	from	3 pcs.	11.05 ea.	Neck diameter d1: 12 mm
	from	10 pcs.	9.80 ea.	Pot height H1: 8.5 mm
	from	20 pcs.	9.20 ea.	Total height H2: 17 mm
	from	40 pcs.	8.65 ea.	Thread M: 8
			Tolerance: +/- 0.5 mm	

## Magnet systems with internal threads

<p><b>ITNG-16</b> magnet system Ø 20 mm black rubber-coated with internal thread thread M4 Weight: 7.5 g strength: approx. 3.2 kg</p>	<p>Price in CHF</p> <p>5 pcs. 2.35 ea. from 15 pcs. 2.08 ea. from 40 pcs. 1.87 ea. from 80 pcs. 1.75 ea.</p>	<p>Covering: Rubber Pot diameter D: 20 mm Pot height H: 6 mm Thread M: 4 Tolerance: +/- 0.1 mm Magnetisation: N42</p>
<p><b>ITNG-25</b> magnet system Ø 29 mm black rubber-coated with internal thread thread M5 Weight: 28 g strength: approx. 11 kg</p>	<p>Price in CHF</p> <p>1 pc. 4.70 ea. from 3 pcs. 4.10 ea. from 10 pcs. 3.60 ea. from 20 pcs. 3.30 ea. from 40 pcs. 3.10 ea.</p>	<p>Covering: Rubber Pot diameter D: 29 mm Pot height H: 8.5 mm Thread M: 5 Tolerance: +/- 0.1 mm Magnetisation: N42</p>
<p><b>ITNG-32</b> magnet system Ø 36 mm black rubber-coated with internal thread thread M6 Weight: 49 g strength: approx. 21 kg</p>	<p>Price in CHF</p> <p>1 pc. 6.80 ea. from 3 pcs. 6.05 ea. from 10 pcs. 5.35 ea. from 20 pcs. 5.05 ea. from 40 pcs. 4.75 ea.</p>	<p>Covering: Rubber Pot diameter D: 36 mm Pot height H: 8.5 mm Thread M: 6 Tolerance: +/- 0.1 mm Magnetisation: N42</p>
<p><b>ITNG-40</b> magnet system Ø 45 mm black rubber-coated with internal thread thread M6 Weight: 80 g strength: approx. 31 kg</p>	<p>Price in CHF</p> <p>1 pc. 9.85 ea. from 3 pcs. 8.85 ea. from 10 pcs. 8.00 ea. from 20 pcs. 7.55 ea. from 40 pcs. 7.20 ea.</p>	<p>Covering: Rubber Pot diameter D: 45 mm Pot height H: 9.5 mm Thread M: 6 Tolerance: +/- 0.1 mm Magnetisation: N42</p>
<p><b>ITNG-66</b> magnet system Ø 66 mm black rubber-coated with internal thread thread M6 Weight: 100 g strength: approx. 25 kg</p>	<p>Price in CHF</p> <p>1 pc. 7.55 ea. from 3 pcs. 6.55 ea. from 10 pcs. 5.70 ea. from 20 pcs. 5.25 ea. from 40 pcs. 4.90 ea.</p>	<p>Covering: Rubber Pot diameter D: 66 mm Pot height H: 8.5 mm Thread M: 6 Tolerance: +/- 0.5 mm Magnetisation: N38</p>
<p><b>ITNG-88</b> magnet system Ø 88 mm black rubber-coated with internal thread thread M6 Weight: 190 g strength: approx. 56 kg</p>	<p>Price in CHF</p> <p>1 pc. 13.45 ea. from 3 pcs. 11.95 ea. from 10 pcs. 10.55 ea. from 20 pcs. 9.90 ea. from 40 pcs. 9.30 ea.</p>	<p>Covering: Rubber (TPV) Pot diameter D: 88 mm Pot height H: 8.5 mm Thread M: 6 Tolerance: +/- 0.5 mm Magnetisation: N38</p>
<p><b>RCNL-43</b> magnet system 43 x 31 mm black rubber-coated with internal thread thread M4 Weight: 28 g strength: approx. 14 kg</p>	<p>Price in CHF</p> <p>1 pc. 4.75 ea. from 3 pcs. 4.10 ea. from 10 pcs. 3.55 ea. from 20 pcs. 3.25 ea. from 40 pcs. 3.00 ea.</p>	<p>Rectangular rubber-coated magnet system with one internal thread. 6 neodymium magnets are embedded in a steel plate, with alternating upward-facing north and south poles.</p>
<p><b>RCNL-43B</b> magnet system 43 x 31 mm black rubber-coated with two internal threads thread M4 Weight: 28 g strength: approx. 14 kg</p>	<p>Price in CHF</p> <p>1 pc. 4.85 ea. from 3 pcs. 4.20 ea. from 10 pcs. 3.65 ea. from 20 pcs. 3.35 ea. from 40 pcs. 3.10 ea.</p>	<p>Rectangular magnet system with two internal threads. Thanks to the rubber coating, perfect for use on delicate surfaces.</p>

<b>ITNGW-22</b> magnet system Ø 22 mm white rubber-coated with internal thread thread M4 Weight: 10 g strength: approx. 5.9 kg		Price in CHF	Pot diameter D: 22 mm
		1 pc.	3.15 ea.
	from	5 pcs.	2.95 ea.
	from	10 pcs.	2.75 ea.
	from	20 pcs.	2.60 ea.
	from	40 pcs.	2.45 ea.
			Pot height H1: 6 mm
			Thread M: 4
			Tolerance: +/- 0.5 mm
			Covering: Rubber (TPV)
			Magnetisation: N42
<b>ITNGW-31</b> magnet system Ø 31 mm white rubber-coated with internal thread thread M5 Weight: 21 g strength: approx. 8 kg		Price in CHF	Pot diameter D: 31 mm
		1 pc.	3.80 ea.
	from	3 pcs.	3.35 ea.
	from	10 pcs.	2.90 ea.
	from	20 pcs.	2.70 ea.
	from	40 pcs.	2.55 ea.
			Pot height H1: 6 mm
			Thread M: 5
			Tolerance: +/- 0.5 mm
			Covering: Rubber (TPV)
			Magnetisation: N42
<b>ITNGW-43</b> magnet system Ø 43 mm white rubber-coated with internal thread thread M4 Weight: 30 g strength: approx. 10 kg		Price in CHF	Pot diameter D: 43 mm
		1 pc.	4.60 ea.
	from	3 pcs.	4.00 ea.
	from	10 pcs.	3.45 ea.
	from	20 pcs.	3.20 ea.
	from	40 pcs.	3.00 ea.
			Pot height H1: 6 mm
			Thread M: 4
			Tolerance: +/- 0.5 mm
			Covering: Rubber (TPV)
			Magnetisation: N42
<b>ITNGW-66</b> magnet system Ø 66 mm white rubber-coated with internal thread thread M6 Weight: 100 g strength: approx. 25 kg		Price in CHF	Pot diameter D: 66 mm
		1 pc.	7.55 ea.
	from	3 pcs.	6.55 ea.
	from	10 pcs.	5.70 ea.
	from	20 pcs.	5.25 ea.
	from	40 pcs.	4.90 ea.
			Pot height H1: 8.5 mm
			Thread M: 6
			Tolerance: +/- 0.5 mm
			Covering: Rubber (TPV)
			Magnetisation: N42
<b>ITNGW-88</b> magnet system Ø 88 mm white rubber-coated with internal thread thread M6 Weight: 190 g strength: approx. 56 kg		Price in CHF	Pot diameter D: 88 mm
		1 pc.	13.45 ea.
	from	3 pcs.	11.95 ea.
	from	10 pcs.	10.55 ea.
	from	20 pcs.	9.90 ea.
	from	40 pcs.	9.30 ea.
			Pot height H1: 8.5 mm
			Thread M: 6
			Tolerance: +/- 0.5 mm
			Covering: Rubber (TPV)
			Magnetisation: N42

## Disc magnets neodymium

<p><b>S-01-01-N</b> Disc magnet Ø 1 mm, height 1 mm, holds approx. 31 g Weight: 0.006 g Nickel-plated (Ni-Cu-Ni) Magnetisation: N45 strength: approx. 31 g</p>	<p>Price in CHF</p> <p>20 pcs. 0.20 ea. from 60 pcs. 0.16 ea. from 140 pcs. 0.14 ea. from 360 pcs. 0.12 ea.</p>	<p>They don't come much smaller than this! Here comes the equivalent to our smallest cube. It's hard to believe, but this little disc magnet is strong enough to pin a little note to the wall.</p>
<p><b>S-1.5-0.5-N</b> Disc magnet Ø 1.5 mm, height 0.5 mm, holds approx. 33 g Weight: 0.0067 g Nickel-plated (Ni-Cu-Ni) Magnetisation: N45 strength: approx. 33 g</p>	<p>Price in CHF</p> <p>20 pcs. 0.21 ea. from 60 pcs. 0.17 ea. from 140 pcs. 0.15 ea. from 360 pcs. 0.13 ea.</p>	
<p><b>S-02-0.7-N</b> Disc magnet Ø 2 mm, height 0.7 mm, holds approx. 74 g Weight: 0.017 g Nickel-plated (Ni-Cu-Ni) Magnetisation: N45 strength: approx. 74 g</p>	<p>Price in CHF</p> <p>20 pcs. 0.21 ea. from 60 pcs. 0.17 ea. from 140 pcs. 0.15 ea. from 360 pcs. 0.13 ea.</p>	
<p><b>S-02-01-N</b> Disc magnet Ø 2 mm, height 1 mm, holds approx. 110 g Weight: 0.024 g Nickel-plated (Ni-Cu-Ni) Magnetisation: N48 strength: approx. 110 g</p>	<p>Price in CHF</p> <p>20 pcs. 0.19 ea. from 60 pcs. 0.16 ea. from 140 pcs. 0.14 ea. from 360 pcs. 0.12 ea.</p>	<p>Bestseller: More than 2 million sold!</p>
<p><b>S-02-02-N</b> Disc magnet Ø 2 mm, height 2 mm, holds approx. 150 g Weight: 0.048 g Nickel-plated (Ni-Cu-Ni) Magnetisation: N48 strength: approx. 150 g</p>	<p>Price in CHF</p> <p>20 pcs. 0.22 ea. from 60 pcs. 0.18 ea. from 140 pcs. 0.16 ea. from 360 pcs. 0.13 ea.</p>	
<p><b>S-2.5-01-N52N</b> Disc magnet Ø 2.5 mm, height 1 mm, holds approx. 160 g Weight: 0.037 g Nickel-plated (Ni-Cu-Ni) Magnetisation: N52 strength: approx. 160 g</p>	<p>Price in CHF</p> <p>20 pcs. 0.20 ea. from 60 pcs. 0.16 ea. from 140 pcs. 0.14 ea. from 360 pcs. 0.12 ea.</p>	<p>A tiny disc magnet with extremely strong N52 magnetisation.</p>
<p><b>S-03-01-N</b> Disc magnet Ø 3 mm, height 1 mm, holds approx. 190 g Weight: 0.054 g Nickel-plated (Ni-Cu-Ni) Magnetisation: N48 strength: approx. 190 g</p>	<p>Price in CHF</p> <p>20 pcs. 0.21 ea. from 60 pcs. 0.17 ea. from 140 pcs. 0.15 ea. from 360 pcs. 0.13 ea.</p>	<p>At the request of our customers from model builder circles, we now carry this tiny magnet weighing only 0.05 g.</p>
<p><b>S-03-02-N</b> Disc magnet Ø 3 mm, height 2 mm, holds approx. 300 g Weight: 0.11 g Nickel-plated (Ni-Cu-Ni) Magnetisation: N48 strength: approx. 300 g</p>	<p>Price in CHF</p> <p>20 pcs. 0.22 ea. from 60 pcs. 0.19 ea. from 140 pcs. 0.16 ea. from 360 pcs. 0.14 ea.</p>	

<p><b>S-03-03-N</b> Disc magnet Ø 3 mm, height 3 mm, holds approx. 330 g Weight: 0.16 g Nickel-plated (Ni-Cu-Ni) Magnetisation: N45 strength: approx. 330 g</p>	<p>Price in CHF</p> <p>20 pcs. 0.24 ea. from 60 pcs. 0.20 ea. from 140 pcs. 0.18 ea. from 360 pcs. 0.15 ea.</p>	
<p><b>S-04-01-N</b> Disc magnet Ø 4 mm, height 1 mm, holds approx. 250 g Weight: 0.096 g Nickel-plated (Ni-Cu-Ni) Magnetisation: N45 strength: approx. 250 g</p>	<p>Price in CHF</p> <p>20 pcs. 0.21 ea. from 60 pcs. 0.18 ea. from 140 pcs. 0.15 ea. from 360 pcs. 0.13 ea.</p>	Tiny disc magnet. Still holds 2 A4 sheets!
<p><b>S-04-1.5-N</b> Disc magnet Ø 4 mm, height 1.5 mm, holds approx. 350 g Weight: 0.14 g Nickel-plated (Ni-Cu-Ni) Magnetisation: N45 strength: approx. 350 g</p>	<p>Price in CHF</p> <p>20 pcs. 0.22 ea. from 60 pcs. 0.19 ea. from 140 pcs. 0.16 ea. from 360 pcs. 0.14 ea.</p>	
<p><b>S-04-02-N</b> Disc magnet Ø 4 mm, height 2 mm, holds approx. 420 g Weight: 0.19 g Nickel-plated (Ni-Cu-Ni) Magnetisation: N45 strength: approx. 420 g</p>	<p>Price in CHF</p> <p>20 pcs. 0.23 ea. from 60 pcs. 0.19 ea. from 140 pcs. 0.17 ea. from 360 pcs. 0.15 ea.</p>	Bestseller: More than 7 million sold!
<p><b>S-04-03-N</b> Disc magnet Ø 4 mm, height 3 mm, holds approx. 530 g Weight: 0.29 g Nickel-plated (Ni-Cu-Ni) Magnetisation: N45 strength: approx. 530 g</p>	<p>Price in CHF</p> <p>10 pcs. 0.28 ea. from 40 pcs. 0.22 ea. from 80 pcs. 0.20 ea. from 160 pcs. 0.18 ea.</p>	
<p><b>S-04-04-N</b> Disc magnet Ø 4 mm, height 4 mm, holds approx. 590 g Weight: 0.38 g Nickel-plated (Ni-Cu-Ni) Magnetisation: N45 strength: approx. 590 g</p>	<p>Price in CHF</p> <p>20 pcs. 0.27 ea. from 60 pcs. 0.23 ea. from 140 pcs. 0.20 ea. from 360 pcs. 0.18 ea.</p>	
<p><b>S-05-01-N</b> Disc magnet Ø 5 mm, height 1 mm, holds approx. 320 g Weight: 0.15 g Nickel-plated (Ni-Cu-Ni) Magnetisation: N45 strength: approx. 320 g</p>	<p>Price in CHF</p> <p>10 pcs. 0.26 ea. from 40 pcs. 0.21 ea. from 80 pcs. 0.19 ea. from 160 pcs. 0.17 ea.</p>	
<p><b>S-05-02-N40N</b> Disc magnet Ø 5 mm, height 2 mm, holds approx. 520 g Weight: 0.3 g Nickel-plated (Ni-Cu-Ni) Magnetisation: N40 strength: approx. 520 g</p>	<p>Price in CHF</p> <p>10 pcs. 0.28 ea. from 40 pcs. 0.22 ea. from 80 pcs. 0.20 ea. from 160 pcs. 0.18 ea.</p>	Same article as S-05-02-N52N, but with weaker magnetisation (N40 instead of N52).
<p><b>S-05-02-N52N</b> Disc magnet Ø 5 mm, height 2 mm, holds approx. 680 g Weight: 0.3 g Nickel-plated (Ni-Cu-Ni) Magnetisation: N52 strength: approx. 680 g</p>	<p>Price in CHF</p> <p>10 pcs. 0.29 ea. from 40 pcs. 0.24 ea. from 80 pcs. 0.21 ea. from 160 pcs. 0.19 ea.</p>	Small disc magnet with extremely strong N52 magnetisation. Holds 6 pieces of A4 paper to a metal wall. It will hold a single piece of paper, a note, or a recipe very firmly in place.



<p><b>S-05-03-N</b> Disc magnet Ø 5 mm, height 3 mm, holds approx. 700 g Weight: 0.45 g Nickel-plated (Ni-Cu-Ni) Magnetisation: N42 strength: approx. 700 g</p>	<p>Price in CHF</p> <p>10 pcs. 0.30 ea. from 40 pcs. 0.24 ea. from 80 pcs. 0.22 ea. from 160 pcs. 0.20 ea.</p>	<p>More than 5.6 million sold</p>
<p><b>S-05-04-N</b> Disc magnet Ø 5 mm, height 4 mm, holds approx. 860 g Weight: 0.6 g Nickel-plated (Ni-Cu-Ni) Magnetisation: N45 strength: approx. 860 g</p>	<p>Price in CHF</p> <p>10 pcs. 0.34 ea. from 40 pcs. 0.28 ea. from 80 pcs. 0.25 ea. from 160 pcs. 0.23 ea.</p>	
<p><b>S-05-05-N</b> Disc magnet Ø 5 mm, height 5 mm, holds approx. 940 g Weight: 0.75 g Nickel-plated (Ni-Cu-Ni) Magnetisation: N45 strength: approx. 940 g</p>	<p>Price in CHF</p> <p>10 pcs. 0.36 ea. from 40 pcs. 0.30 ea. from 80 pcs. 0.27 ea. from 160 pcs. 0.25 ea.</p>	<p>Even this small magnet, which weighs less than 1 gramme, is able to attract another magnet through a human finger.</p>
<p><b>S-05-05-T</b> Disc magnet Ø 5 mm, height 5 mm, holds approx. 940 g Weight: 0.75 g coated with PTFE Magnetisation: N45 strength: approx. 940 g</p>	<p>Price in CHF</p> <p>20 pcs. 0.34 ea. from 60 pcs. 0.29 ea. from 140 pcs. 0.26 ea. from 360 pcs. 0.23 ea.</p>	<p>Its non-stick coating gives this disc magnet a dark-grey colour. The coating makes the magnet nearly waterproof and very abrasion-proof.</p>
<p><b>S-06-01-N</b> Disc magnet Ø 6 mm, height 1 mm, holds approx. 400 g Weight: 0.21 g Nickel-plated (Ni-Cu-Ni) Magnetisation: N45 strength: approx. 400 g</p>	<p>Price in CHF</p> <p>20 pcs. 0.24 ea. from 60 pcs. 0.20 ea. from 140 pcs. 0.17 ea. from 360 pcs. 0.15 ea.</p>	<p>An invitation with an unusual magnetic closure? A box whose top closes as if by magic? You can realise these and many other ideas with these 1 mm thick flat disc magnet.</p>
<p><b>S-06-02-G</b> Disc magnet Ø 6 mm, height 2 mm, holds approx. 740 g Weight: 0.43 g Gold-plated (Ni-Cu-Ni-Au) Magnetisation: N45 strength: approx. 740 g</p>	<p>Price in CHF</p> <p>10 pcs. 0.33 ea. from 40 pcs. 0.27 ea. from 80 pcs. 0.24 ea. from 160 pcs. 0.22 ea.</p>	
<p><b>S-06-02-N</b> Disc magnet Ø 6 mm, height 2 mm, holds approx. 740 g Weight: 0.43 g Nickel-plated (Ni-Cu-Ni) Magnetisation: N45 strength: approx. 740 g</p>	<p>Price in CHF</p> <p>10 pcs. 0.31 ea. from 40 pcs. 0.25 ea. from 80 pcs. 0.23 ea. from 160 pcs. 0.20 ea.</p>	<p>Extra super strong (=N45) disc magnet. Even such a pipsqueak can hold 7 pieces of A4 paper (80g/m<sup>2</sup>) to a metal plate (see photos).</p>
<p><b>S-06-03-N</b> Disc magnet Ø 6 mm, height 3 mm, holds approx. 990 g Weight: 0.64 g Nickel-plated (Ni-Cu-Ni) Magnetisation: N45 strength: approx. 990 g</p>	<p>Price in CHF</p> <p>10 pcs. 0.33 ea. from 40 pcs. 0.27 ea. from 80 pcs. 0.24 ea. from 160 pcs. 0.22 ea.</p>	
<p><b>S-06-04-N</b> Disc magnet Ø 6 mm, height 4 mm, holds approx. 1.2 kg Weight: 0.86 g Nickel-plated (Ni-Cu-Ni) Magnetisation: N45 strength: approx. 1.2 kg</p>	<p>Price in CHF</p> <p>10 pcs. 0.39 ea. from 40 pcs. 0.32 ea. from 80 pcs. 0.29 ea. from 160 pcs. 0.27 ea.</p>	

<p><b>S-06-06-N</b> Disc magnet Ø 6 mm, height 6 mm, holds approx. 1.5 kg Weight: 1.3 g Nickel-plated (Ni-Cu-Ni) Magnetisation: N48 strength: approx. 1.5 kg</p>	<p>Price in CHF</p> <table> <tr><td>10 pcs.</td><td>0.47 ea.</td></tr> <tr><td>from 40 pcs.</td><td>0.40 ea.</td></tr> <tr><td>from 80 pcs.</td><td>0.36 ea.</td></tr> <tr><td>from 160 pcs.</td><td>0.34 ea.</td></tr> </table>	10 pcs.	0.47 ea.	from 40 pcs.	0.40 ea.	from 80 pcs.	0.36 ea.	from 160 pcs.	0.34 ea.	
10 pcs.	0.47 ea.									
from 40 pcs.	0.40 ea.									
from 80 pcs.	0.36 ea.									
from 160 pcs.	0.34 ea.									
<p><b>S-08-01-N</b> Disc magnet Ø 8 mm, height 1 mm, holds approx. 540 g Weight: 0.38 g Nickel-plated (Ni-Cu-Ni) Magnetisation: N45 strength: approx. 540 g</p>	<p>Price in CHF</p> <table> <tr><td>10 pcs.</td><td>0.29 ea.</td></tr> <tr><td>from 40 pcs.</td><td>0.24 ea.</td></tr> <tr><td>from 80 pcs.</td><td>0.21 ea.</td></tr> <tr><td>from 160 pcs.</td><td>0.19 ea.</td></tr> </table>	10 pcs.	0.29 ea.	from 40 pcs.	0.24 ea.	from 80 pcs.	0.21 ea.	from 160 pcs.	0.19 ea.	
10 pcs.	0.29 ea.									
from 40 pcs.	0.24 ea.									
from 80 pcs.	0.21 ea.									
from 160 pcs.	0.19 ea.									
<p><b>S-08-02-N</b> Disc magnet Ø 8 mm, height 2 mm, holds approx. 1.1 kg Weight: 0.76 g Nickel-plated (Ni-Cu-Ni) Magnetisation: N45 strength: approx. 1.1 kg</p>	<p>Price in CHF</p> <table> <tr><td>10 pcs.</td><td>0.36 ea.</td></tr> <tr><td>from 40 pcs.</td><td>0.29 ea.</td></tr> <tr><td>from 80 pcs.</td><td>0.27 ea.</td></tr> <tr><td>from 160 pcs.</td><td>0.24 ea.</td></tr> </table>	10 pcs.	0.36 ea.	from 40 pcs.	0.29 ea.	from 80 pcs.	0.27 ea.	from 160 pcs.	0.24 ea.	<p>A small flat neodymium magnet with an adhesive force of about 1 kg. Our customers use it, for instance, for magnetic buttons or manual training in school.</p>
10 pcs.	0.36 ea.									
from 40 pcs.	0.29 ea.									
from 80 pcs.	0.27 ea.									
from 160 pcs.	0.24 ea.									
<p><b>S-08-03-G</b> Disc magnet Ø 8 mm, height 3 mm, holds approx. 1.3 kg Weight: 1.1 g Gold-plated (Ni-Cu-Ni-Au) Magnetisation: N40 strength: approx. 1.3 kg</p>	<p>Price in CHF</p> <table> <tr><td>10 pcs.</td><td>0.41 ea.</td></tr> <tr><td>from 40 pcs.</td><td>0.34 ea.</td></tr> <tr><td>from 80 pcs.</td><td>0.31 ea.</td></tr> <tr><td>from 160 pcs.</td><td>0.28 ea.</td></tr> </table>	10 pcs.	0.41 ea.	from 40 pcs.	0.34 ea.	from 80 pcs.	0.31 ea.	from 160 pcs.	0.28 ea.	
10 pcs.	0.41 ea.									
from 40 pcs.	0.34 ea.									
from 80 pcs.	0.31 ea.									
from 160 pcs.	0.28 ea.									
<p><b>S-08-03-E</b> Disc magnet Ø 8 mm, height 3 mm, holds approx. 1.5 kg Weight: 1.1 g Epoxy coating (Ni-Cu-Ni-Epoxy) Magnetisation: N45 strength: approx. 1.5 kg</p>	<p>Price in CHF</p> <table> <tr><td>10 pcs.</td><td>0.44 ea.</td></tr> <tr><td>from 40 pcs.</td><td>0.37 ea.</td></tr> <tr><td>from 80 pcs.</td><td>0.34 ea.</td></tr> <tr><td>from 160 pcs.</td><td>0.31 ea.</td></tr> </table>	10 pcs.	0.44 ea.	from 40 pcs.	0.37 ea.	from 80 pcs.	0.34 ea.	from 160 pcs.	0.31 ea.	<p>A disc magnet 8 x 3 mm with a Ni-Cu-Ni base coating and a top coat of black epoxy resin. It can be glued or cast with epoxy resin.</p>
10 pcs.	0.44 ea.									
from 40 pcs.	0.37 ea.									
from 80 pcs.	0.34 ea.									
from 160 pcs.	0.31 ea.									
<p><b>S-08-03-N</b> Disc magnet Ø 8 mm, height 3 mm, holds approx. 1.5 kg Weight: 1.1 g Nickel-plated (Ni-Cu-Ni) Magnetisation: N45 strength: approx. 1.5 kg</p>	<p>Price in CHF</p> <table> <tr><td>10 pcs.</td><td>0.42 ea.</td></tr> <tr><td>from 40 pcs.</td><td>0.35 ea.</td></tr> <tr><td>from 80 pcs.</td><td>0.32 ea.</td></tr> <tr><td>from 160 pcs.</td><td>0.29 ea.</td></tr> </table>	10 pcs.	0.42 ea.	from 40 pcs.	0.35 ea.	from 80 pcs.	0.32 ea.	from 160 pcs.	0.29 ea.	<p>A good size for various craft projects, name tags at weddings, small refrigerator magnets, hanging-up posters...</p>
10 pcs.	0.42 ea.									
from 40 pcs.	0.35 ea.									
from 80 pcs.	0.32 ea.									
from 160 pcs.	0.29 ea.									
<p><b>S-08-04-N</b> Disc magnet Ø 8 mm, height 4 mm, holds approx. 1.8 kg Weight: 1.5 g Nickel-plated (Ni-Cu-Ni) Magnetisation: N45 strength: approx. 1.8 kg</p>	<p>Price in CHF</p> <table> <tr><td>10 pcs.</td><td>0.48 ea.</td></tr> <tr><td>from 40 pcs.</td><td>0.40 ea.</td></tr> <tr><td>from 80 pcs.</td><td>0.37 ea.</td></tr> <tr><td>from 160 pcs.</td><td>0.34 ea.</td></tr> </table>	10 pcs.	0.48 ea.	from 40 pcs.	0.40 ea.	from 80 pcs.	0.37 ea.	from 160 pcs.	0.34 ea.	
10 pcs.	0.48 ea.									
from 40 pcs.	0.40 ea.									
from 80 pcs.	0.37 ea.									
from 160 pcs.	0.34 ea.									
<p><b>S-08-05-E</b> Disc magnet Ø 8 mm, height 5 mm, holds approx. 2 kg Weight: 1.9 g Epoxy coating (Ni-Cu-Ni-Epoxy) Magnetisation: N45 strength: approx. 2 kg</p>	<p>Price in CHF</p> <table> <tr><td>5 pcs.</td><td>0.67 ea.</td></tr> <tr><td>from 15 pcs.</td><td>0.58 ea.</td></tr> <tr><td>from 40 pcs.</td><td>0.52 ea.</td></tr> <tr><td>from 80 pcs.</td><td>0.48 ea.</td></tr> </table>	5 pcs.	0.67 ea.	from 15 pcs.	0.58 ea.	from 40 pcs.	0.52 ea.	from 80 pcs.	0.48 ea.	
5 pcs.	0.67 ea.									
from 15 pcs.	0.58 ea.									
from 40 pcs.	0.52 ea.									
from 80 pcs.	0.48 ea.									
<p><b>S-08-05-N</b> Disc magnet Ø 8 mm, height 5 mm, holds approx. 2 kg Weight: 1.9 g Nickel-plated (Ni-Cu-Ni) Magnetisation: N45 strength: approx. 2 kg</p>	<p>Price in CHF</p> <table> <tr><td>5 pcs.</td><td>0.59 ea.</td></tr> <tr><td>from 15 pcs.</td><td>0.51 ea.</td></tr> <tr><td>from 40 pcs.</td><td>0.45 ea.</td></tr> <tr><td>from 80 pcs.</td><td>0.42 ea.</td></tr> </table>	5 pcs.	0.59 ea.	from 15 pcs.	0.51 ea.	from 40 pcs.	0.45 ea.	from 80 pcs.	0.42 ea.	<p>A solid but small disc magnet with an adhesive force of 2 kg. A practical but safe size - one of our magnet bestsellers.</p>
5 pcs.	0.59 ea.									
from 15 pcs.	0.51 ea.									
from 40 pcs.	0.45 ea.									
from 80 pcs.	0.42 ea.									

<p><b>S-08-06-N52N</b> Disc magnet Ø 8 mm, height 6 mm, holds approx. 2.6 kg Weight: 2.3 g Nickel-plated (Ni-Cu-Ni) Magnetisation: N52 strength: approx. 2.6 kg</p>	<p>Price in CHF</p> <p>20 pcs. 0.69 ea. from 60 pcs. 0.61 ea. from 140 pcs. 0.56 ea. from 360 pcs. 0.51 ea.</p>	<p>Small, compact disc magnet with extremely strong N52 magnetisation. Despite its small size it can hold up to 2,5 kg!</p>
<p><b>S-08-08-K</b> Disc magnet Ø 8 mm, height 8 mm, holds approx. 2.5 kg Weight: 3.1 g copper-plated (Ni-Cu) Magnetisation: N45 strength: approx. 2.5 kg</p>	<p>Price in CHF</p> <p>5 pcs. 0.75 ea. from 15 pcs. 0.66 ea. from 40 pcs. 0.59 ea. from 80 pcs. 0.55 ea.</p>	<p>Strong disc magnets in trendy copper-colour! These magnets shimmer reddish-brown-golden and are the eye-catcher on glass magnetic boards and magnetic boards.</p>
<p><b>S-08-08-N</b> Disc magnet Ø 8 mm, height 8 mm, holds approx. 2.5 kg Weight: 3.1 g Nickel-plated (Ni-Cu-Ni) Magnetisation: N45 strength: approx. 2.5 kg</p>	<p>Price in CHF</p> <p>5 pcs. 0.73 ea. from 15 pcs. 0.64 ea. from 40 pcs. 0.58 ea. from 80 pcs. 0.54 ea.</p>	<p>This disc magnet works well on magnetic glass boards.</p>
<p><b>S-09-03-N52N</b> Disc magnet Ø 9 mm, height 3 mm, holds approx. 2 kg Weight: 1.5 g Nickel-plated (Ni-Cu-Ni) Magnetisation: N52 strength: approx. 2 kg</p>	<p>Price in CHF</p> <p>5 pcs. 0.62 ea. from 15 pcs. 0.54 ea. from 40 pcs. 0.48 ea. from 80 pcs. 0.44 ea.</p>	<p>The small flat disc magnet with the extremely strong N52 magnetisation. Despite its small dimensions it features an adhesive force of almost 2 kg.</p>
<p><b>S-09-05-N</b> Disc magnet Ø 9 mm, height 5 mm, holds approx. 2.7 kg Weight: 2.4 g Nickel-plated (Ni-Cu-Ni) Magnetisation: N50 strength: approx. 2.7 kg</p>	<p>Price in CHF</p> <p>10 pcs. 0.66 ea. from 40 pcs. 0.56 ea. from 80 pcs. 0.52 ea. from 160 pcs. 0.48 ea.</p>	
<p><b>S-10-0.6-N</b> Disc magnet Ø 10 mm, height 0.6 mm, holds approx. 310 g Weight: 0.36 g Nickel-plated (Ni-Cu-Ni) Magnetisation: N35 strength: approx. 310 g</p>	<p>Price in CHF</p> <p>20 pcs. 0.28 ea. from 60 pcs. 0.24 ea. from 140 pcs. 0.21 ea. from 360 pcs. 0.18 ea.</p>	
<p><b>S-10-01-N</b> Disc magnet Ø 10 mm, height 1 mm, holds approx. 540 g Weight: 0.6 g Nickel-plated (Ni-Cu-Ni) Magnetisation: N35 strength: approx. 540 g</p>	<p>Price in CHF</p> <p>20 pcs. 0.29 ea. from 60 pcs. 0.25 ea. from 140 pcs. 0.22 ea. from 360 pcs. 0.19 ea.</p>	
<p><b>S-10-1.5-N</b> Disc magnet Ø 10 mm, height 1.5 mm, holds approx. 970 g Weight: 0.9 g Nickel-plated (Ni-Cu-Ni) Magnetisation: N42 strength: approx. 970 g</p>	<p>Price in CHF</p> <p>10 pcs. 0.40 ea. from 40 pcs. 0.33 ea. from 80 pcs. 0.30 ea. from 160 pcs. 0.28 ea.</p>	
<p><b>S-10-1.5-N52N</b> Disc magnet Ø 10 mm, height 1.5 mm, holds approx. 1.2 kg Weight: 0.9 g Nickel-plated (Ni-Cu-Ni) Magnetisation: N52 strength: approx. 1.2 kg</p>	<p>Price in CHF</p> <p>10 pcs. 0.40 ea. from 40 pcs. 0.33 ea. from 80 pcs. 0.30 ea. from 160 pcs. 0.28 ea.</p>	<p>This disc magnet looks identical to the S-10-1.5-N, but thanks to the N52 magnetisation it features an even higher adhesive force.</p>

<p><b>S-10-02-N</b> Disc magnet Ø 10 mm, height 2 mm, holds approx. 1.3 kg Weight: 1.2 g Nickel-plated (Ni-Cu-Ni) Magnetisation: N42 strength: approx. 1.3 kg</p>	<p>Price in CHF</p> <p>10 pcs. 0.44 ea. from 40 pcs. 0.37 ea. from 80 pcs. 0.34 ea. from 160 pcs. 0.31 ea.</p>	<p>An adhesive force of about 1 kg with a 10 mm diameter and a 2 mm thickness make this disc magnet a top seller. It might be because you can embed it nicely.</p>
<p><b>S-10-2.5-N</b> Disc magnet Ø 10 mm, height 2.5 mm, holds approx. 1.6 kg Weight: 1.5 g Nickel-plated (Ni-Cu-Ni) Magnetisation: N42 strength: approx. 1.6 kg</p>	<p>Price in CHF</p> <p>10 pcs. 0.48 ea. from 40 pcs. 0.41 ea. from 80 pcs. 0.37 ea. from 160 pcs. 0.35 ea.</p>	
<p><b>S-10-03-N</b> Disc magnet Ø 10 mm, height 3 mm, holds approx. 1.8 kg Weight: 1.8 g Nickel-plated (Ni-Cu-Ni) Magnetisation: N42 strength: approx. 1.8 kg</p>	<p>Price in CHF</p> <p>10 pcs. 0.49 ea. from 40 pcs. 0.41 ea. from 80 pcs. 0.37 ea. from 160 pcs. 0.34 ea.</p>	<p>This reasonably priced magnet is wonderfully suitable for various craft projects. If you, for example, glue it to glass beads, you will have a very strong refrigerator or whiteboard magnet that can easily hold 15 pieces of A4 paper!</p>
<p><b>S-10-03-N52N</b> Disc magnet Ø 10 mm, height 3 mm, holds approx. 2.3 kg Weight: 1.8 g Nickel-plated (Ni-Cu-Ni) Magnetisation: N52 strength: approx. 2.3 kg</p>	<p>Price in CHF</p> <p>5 pcs. 0.60 ea. from 15 pcs. 0.52 ea. from 40 pcs. 0.46 ea. from 80 pcs. 0.43 ea.</p>	<p>This disc magnet looks identical to the S-10-03-N, but possesses an even higher adhesive force, thanks to the N52 magnetisation, which makes it even more versatile</p>
<p><b>S-10-04-N</b> Disc magnet Ø 10 mm, height 4 mm, holds approx. 2.3 kg Weight: 2.4 g Nickel-plated (Ni-Cu-Ni) Magnetisation: N42 strength: approx. 2.3 kg</p>	<p>Price in CHF</p> <p>5 pcs. 0.65 ea. from 15 pcs. 0.56 ea. from 40 pcs. 0.50 ea. from 80 pcs. 0.47 ea.</p>	
<p><b>S-10-05-DN</b> Disc magnet Ø 10 mm, height 5 mm, holds approx. 1 kg Weight: 3 g Nickel-plated (Ni-Cu-Ni) Magnetisation: N45 strength: approx. 1 kg</p>	<p>Price in CHF</p> <p>5 pcs. 0.83 ea. from 15 pcs. 0.73 ea. from 40 pcs. 0.66 ea. from 80 pcs. 0.61 ea.</p>	<p>Diametrically magnetised disc magnet.</p>
<p><b>S-10-05-E</b> Disc magnet Ø 10 mm, height 5 mm, holds approx. 2 kg Weight: 3 g Epoxy coating (Ni-Cu-Ni-Epoxy) Magnetisation: N42 strength: approx. 2 kg</p>	<p>Price in CHF</p> <p>5 pcs. 0.83 ea. from 15 pcs. 0.72 ea. from 40 pcs. 0.65 ea. from 80 pcs. 0.60 ea.</p>	<p>A disc magnet 10 x 5 mm with a Ni-Cu-Ni base coating and a top coat of black epoxy resin. It can be glued or cast with epoxy resin.</p>
<p><b>S-10-05-N</b> Disc magnet Ø 10 mm, height 5 mm, holds approx. 2.6 kg Weight: 3 g Nickel-plated (Ni-Cu-Ni) Magnetisation: N42 strength: approx. 2.6 kg</p>	<p>Price in CHF</p> <p>5 pcs. 0.69 ea. from 15 pcs. 0.60 ea. from 40 pcs. 0.53 ea. from 80 pcs. 0.49 ea.</p>	<p>These handy all-purpose magnets are so nicely-sized and so strong for such an unbelievable price that there will be no excuse for finding yourself without them in an emergency. :-)</p>
<p><b>S-10-05-N52N</b> Disc magnet Ø 10 mm, height 5 mm, holds approx. 3.3 kg Weight: 3 g Nickel-plated (Ni-Cu-Ni) Magnetisation: N52 strength: approx. 3.3 kg</p>	<p>Price in CHF</p> <p>5 pcs. 0.72 ea. from 15 pcs. 0.63 ea. from 40 pcs. 0.56 ea. from 80 pcs. 0.52 ea.</p>	<p>This disc magnet looks identical to the S-10-05-N, but possesses an even higher adhesive force, thanks to the N52 magnetisation, which makes it even more versatile</p>

<p><b>S-10-10-N</b> Disc magnet Ø 10 mm, height 10 mm, holds approx. 3.9 kg Weight: 6 g Nickel-plated (Ni-Cu-Ni) Magnetisation: N45 strength: approx. 3.9 kg</p>	<p>Price in CHF</p> <p>5 pcs. 1.18 ea. from 15 pcs. 1.05 ea. from 40 pcs. 0.95 ea. from 80 pcs. 0.90 ea.</p>	<p>In between disc magnet and rod magnet. With almost 4 kg adhesive force extremely strong for its size. Great price-performance ratio.</p>
<p><b>S-12-01-N</b> Disc magnet Ø 12 mm, height 1 mm, holds approx. 770 g Weight: 0.86 g Nickel-plated (Ni-Cu-Ni) Magnetisation: N42 strength: approx. 770 g</p>	<p>Price in CHF</p> <p>20 pcs. 0.31 ea. from 60 pcs. 0.27 ea. from 140 pcs. 0.24 ea. from 360 pcs. 0.21 ea.</p>	
<p><b>S-12-02-N</b> Disc magnet Ø 12 mm, height 2 mm, holds approx. 1.7 kg Weight: 1.7 g Nickel-plated (Ni-Cu-Ni) Magnetisation: N45 strength: approx. 1.7 kg</p>	<p>Price in CHF</p> <p>5 pcs. 0.60 ea. from 15 pcs. 0.52 ea. from 40 pcs. 0.46 ea. from 80 pcs. 0.42 ea.</p>	
<p><b>S-12-03-N</b> Disc magnet Ø 12 mm, height 3 mm, holds approx. 2.4 kg Weight: 2.6 g Nickel-plated (Ni-Cu-Ni) Magnetisation: N45 strength: approx. 2.4 kg</p>	<p>Price in CHF</p> <p>5 pcs. 0.69 ea. from 15 pcs. 0.60 ea. from 40 pcs. 0.53 ea. from 80 pcs. 0.50 ea.</p>	
<p><b>S-12-04-N</b> Disc magnet Ø 12 mm, height 4 mm, holds approx. 3.1 kg Weight: 3.4 g Nickel-plated (Ni-Cu-Ni) Magnetisation: N45 strength: approx. 3.1 kg</p>	<p>Price in CHF</p> <p>5 pcs. 0.90 ea. from 15 pcs. 0.79 ea. from 40 pcs. 0.71 ea. from 80 pcs. 0.66 ea.</p>	
<p><b>S-12-05-N</b> Disc magnet Ø 12 mm, height 5 mm, holds approx. 3.6 kg Weight: 4.3 g Nickel-plated (Ni-Cu-Ni) Magnetisation: N45 strength: approx. 3.6 kg</p>	<p>Price in CHF</p> <p>5 pcs. 0.94 ea. from 15 pcs. 0.82 ea. from 40 pcs. 0.74 ea. from 80 pcs. 0.69 ea.</p>	
<p><b>S-12-06-DN</b> Disc magnet Ø 12 mm, height 6 mm, holds approx. 1.9 kg Weight: 5.2 g Nickel-plated (Ni-Cu-Ni) Magnetisation: N42 strength: approx. 1.9 kg</p>	<p>Price in CHF</p> <p>1 pc. 1.65 ea. from 3 pcs. 1.45 ea. from 10 pcs. 1.30 ea. from 20 pcs. 1.20 ea. from 40 pcs. 1.15 ea.</p>	<p>Diametrically magnetised disc magnet.</p>
<p><b>S-12-06-K</b> Disc magnet Ø 12 mm, height 6 mm, holds approx. 4.1 kg Weight: 5.2 g copper-plated (Ni-Cu) Magnetisation: N45 strength: approx. 4.1 kg</p>	<p>Price in CHF</p> <p>5 pcs. 1.09 ea. from 15 pcs. 0.96 ea. from 40 pcs. 0.87 ea. from 80 pcs. 0.82 ea.</p>	<p>Strong disc magnets in trendy copper-colour! These magnets shimmer reddish-brown-golden and are the eye-catcher on glass magnetic boards and magnetic boards.</p>
<p><b>S-12-06-N</b> Disc magnet Ø 12 mm, height 6 mm, holds approx. 4.1 kg Weight: 5.2 g Nickel-plated (Ni-Cu-Ni) Magnetisation: N45 strength: approx. 4.1 kg</p>	<p>Price in CHF</p> <p>5 pcs. 1.04 ea. from 15 pcs. 0.91 ea. from 40 pcs. 0.82 ea. from 80 pcs. 0.77 ea.</p>	<p>If you feel that it would be a good idea to hang the shopping list on the refrigerator with this magnet, then you haven't quite grasped the concept of super magnets: Forget it! You'll never be able to get it off the refrigerator with your bare hands!</p>

<p><b>S-12-08-N</b> Disc magnet Ø 12 mm, height 8 mm, holds approx. 4.8 kg Weight: 6.9 g Nickel-plated (Ni-Cu-Ni) Magnetisation: N45 strength: approx. 4.8 kg</p>	<p>Price in CHF</p> <p>5 pcs. 1.30 ea. from 15 pcs. 1.16 ea. from 40 pcs. 1.05 ea. from 80 pcs. 0.99 ea.</p>	
<p><b>S-12-10-N</b> Disc magnet Ø 12 mm, height 10 mm, holds approx. 5.3 kg Weight: 8.6 g Nickel-plated (Ni-Cu-Ni) Magnetisation: N45 strength: approx. 5.3 kg</p>	<p>Price in CHF</p> <p>1 pc. 1.90 ea. from 3 pcs. 1.70 ea. from 10 pcs. 1.50 ea. from 20 pcs. 1.40 ea. from 40 pcs. 1.30 ea.</p>	
<p><b>S-13-01-N</b> Disc magnet Ø 13 mm, height 1 mm, holds approx. 910 g Weight: 1 g Nickel-plated (Ni-Cu-Ni) Magnetisation: N45 strength: approx. 910 g</p>	<p>Price in CHF</p> <p>20 pcs. 0.31 ea. from 60 pcs. 0.26 ea. from 140 pcs. 0.23 ea. from 360 pcs. 0.21 ea.</p>	
<p><b>S-13-02-N</b> Disc magnet Ø 13 mm, height 2 mm, holds approx. 1.8 kg Weight: 2 g Nickel-plated (Ni-Cu-Ni) Magnetisation: N45 strength: approx. 1.8 kg</p>	<p>Price in CHF</p> <p>5 pcs. 0.61 ea. from 15 pcs. 0.53 ea. from 40 pcs. 0.47 ea. from 80 pcs. 0.43 ea.</p>	
<p><b>S-15-02-N</b> Disc magnet Ø 15 mm, height 2 mm, holds approx. 1.9 kg Weight: 2.7 g Nickel-plated (Ni-Cu-Ni) Magnetisation: N40 strength: approx. 1.9 kg</p>	<p>Price in CHF</p> <p>5 pcs. 0.66 ea. from 15 pcs. 0.58 ea. from 40 pcs. 0.52 ea. from 80 pcs. 0.48 ea.</p>	
<p><b>S-15-03-N</b> Disc magnet Ø 15 mm, height 3 mm, holds approx. 3.2 kg Weight: 4 g Nickel-plated (Ni-Cu-Ni) Magnetisation: N45 strength: approx. 3.2 kg</p>	<p>Price in CHF</p> <p>5 pcs. 0.93 ea. from 15 pcs. 0.82 ea. from 40 pcs. 0.74 ea. from 80 pcs. 0.68 ea.</p>	<p>Top seller! For this disc magnet with its adhesive force of approx. 3 kg, normal whiteboard and magnetic board applications do not present a real challenge. This magnet is simply created for a higher purpose and it favours a heavier burden.</p>
<p><b>S-15-03-N52N</b> Disc magnet Ø 15 mm, height 3 mm, holds approx. 3.7 kg Weight: 4 g Nickel-plated (Ni-Cu-Ni) Magnetisation: N52 strength: approx. 3.7 kg</p>	<p>Price in CHF</p> <p>5 pcs. 0.99 ea. from 15 pcs. 0.87 ea. from 40 pcs. 0.79 ea. from 80 pcs. 0.74 ea.</p>	<p>This disc magnet looks identical to the S-15-03-N, but possesses an even higher adhesive force, thanks to the N52 magnetisation, which makes it even more versatile</p>
<p><b>S-15-05-N</b> Disc magnet Ø 15 mm, height 5 mm, holds approx. 4.5 kg Weight: 6.7 g Nickel-plated (Ni-Cu-Ni) Magnetisation: N42 strength: approx. 4.5 kg</p>	<p>Price in CHF</p> <p>5 pcs. 1.28 ea. from 15 pcs. 1.13 ea. from 40 pcs. 1.02 ea. from 80 pcs. 0.95 ea.</p>	<p>This inconspicuous disc magnet has an adhesive force of more than 4 kg and can be easily embedded. A great price-performance ratio!</p>
<p><b>S-15-08-K</b> Disc magnet Ø 15 mm, height 8 mm, holds approx. 6.2 kg Weight: 11 g copper-plated (Ni-Cu) Magnetisation: N42 strength: approx. 6.2 kg</p>	<p>Price in CHF</p> <p>1 pc. 1.90 ea. from 3 pcs. 1.70 ea. from 10 pcs. 1.50 ea. from 20 pcs. 1.40 ea. from 40 pcs. 1.30 ea.</p>	<p>Strong disc magnets in trendy copper-colour! These magnets shimmer reddish-brown-golden and are the eye-catcher on glass magnetic boards, on which they securely hold even cardboard.</p>

<p><b>S-15-08-N</b> Disc magnet Ø 15 mm, height 8 mm, holds approx. 6.2 kg Weight: 11 g Nickel-plated (Ni-Cu-Ni) Magnetisation: N42 strength: approx. 6.2 kg</p>	<p>Price in CHF</p> <table> <tr><td>1 pc.</td><td>1.95 ea.</td></tr> <tr><td>from 3 pcs.</td><td>1.75 ea.</td></tr> <tr><td>from 10 pcs.</td><td>1.50 ea.</td></tr> <tr><td>from 20 pcs.</td><td>1.40 ea.</td></tr> <tr><td>from 40 pcs.</td><td>1.35 ea.</td></tr> </table>	1 pc.	1.95 ea.	from 3 pcs.	1.75 ea.	from 10 pcs.	1.50 ea.	from 20 pcs.	1.40 ea.	from 40 pcs.	1.35 ea.	<p>A good in-between size! Not so painfully big, but definitely impressively strong. This magnet can hold 35 sheets of A4 paper on a metal cabinet. If this one is not going to be a big hit, I'll go get another job.</p>
1 pc.	1.95 ea.											
from 3 pcs.	1.75 ea.											
from 10 pcs.	1.50 ea.											
from 20 pcs.	1.40 ea.											
from 40 pcs.	1.35 ea.											
<p><b>S-18-02-N</b> Disc magnet Ø 18 mm, height 2 mm, holds approx. 2.6 kg Weight: 3.9 g Nickel-plated (Ni-Cu-Ni) Magnetisation: N45 strength: approx. 2.6 kg</p>	<p>Price in CHF</p> <table> <tr><td>5 pcs.</td><td>0.92 ea.</td></tr> <tr><td>from 15 pcs.</td><td>0.82 ea.</td></tr> <tr><td>from 40 pcs.</td><td>0.74 ea.</td></tr> <tr><td>from 80 pcs.</td><td>0.69 ea.</td></tr> </table>	5 pcs.	0.92 ea.	from 15 pcs.	0.82 ea.	from 40 pcs.	0.74 ea.	from 80 pcs.	0.69 ea.			
5 pcs.	0.92 ea.											
from 15 pcs.	0.82 ea.											
from 40 pcs.	0.74 ea.											
from 80 pcs.	0.69 ea.											
<p><b>S-20-1.5-N</b> Disc magnet Ø 20 mm, height 1.5 mm, holds approx. 1.8 kg Weight: 3.6 g Nickel-plated (Ni-Cu-Ni) Magnetisation: N38 strength: approx. 1.8 kg</p>	<p>Price in CHF</p> <table> <tr><td>5 pcs.</td><td>0.82 ea.</td></tr> <tr><td>from 15 pcs.</td><td>0.72 ea.</td></tr> <tr><td>from 40 pcs.</td><td>0.64 ea.</td></tr> <tr><td>from 80 pcs.</td><td>0.60 ea.</td></tr> </table>	5 pcs.	0.82 ea.	from 15 pcs.	0.72 ea.	from 40 pcs.	0.64 ea.	from 80 pcs.	0.60 ea.			
5 pcs.	0.82 ea.											
from 15 pcs.	0.72 ea.											
from 40 pcs.	0.64 ea.											
from 80 pcs.	0.60 ea.											
<p><b>S-20-02-N</b> Disc magnet Ø 20 mm, height 2 mm, holds approx. 2.9 kg Weight: 4.8 g Nickel-plated (Ni-Cu-Ni) Magnetisation: N45 strength: approx. 2.9 kg</p>	<p>Price in CHF</p> <table> <tr><td>5 pcs.</td><td>1.05 ea.</td></tr> <tr><td>from 15 pcs.</td><td>0.93 ea.</td></tr> <tr><td>from 40 pcs.</td><td>0.84 ea.</td></tr> <tr><td>from 80 pcs.</td><td>0.78 ea.</td></tr> </table>	5 pcs.	1.05 ea.	from 15 pcs.	0.93 ea.	from 40 pcs.	0.84 ea.	from 80 pcs.	0.78 ea.	<p>An extremely flat disc magnet with an adhesive force of 2 kg. Affordable and discreet - one of our bestsellers! Perfect for closures and fasteners of all kind.</p>		
5 pcs.	1.05 ea.											
from 15 pcs.	0.93 ea.											
from 40 pcs.	0.84 ea.											
from 80 pcs.	0.78 ea.											
<p><b>S-20-02-N52N</b> Disc magnet Ø 20 mm, height 2 mm, holds approx. 3.4 kg Weight: 4.8 g Nickel-plated (Ni-Cu-Ni) Magnetisation: N52 strength: approx. 3.4 kg</p>	<p>Price in CHF</p> <table> <tr><td>5 pcs.</td><td>1.20 ea.</td></tr> <tr><td>from 15 pcs.</td><td>1.06 ea.</td></tr> <tr><td>from 40 pcs.</td><td>0.96 ea.</td></tr> <tr><td>from 80 pcs.</td><td>0.90 ea.</td></tr> </table>	5 pcs.	1.20 ea.	from 15 pcs.	1.06 ea.	from 40 pcs.	0.96 ea.	from 80 pcs.	0.90 ea.	<p>This disc magnet looks identical to the S-20-02-N, but possesses an even higher adhesive force, thanks to the N52 magnetisation, which makes it even more versatile</p>		
5 pcs.	1.20 ea.											
from 15 pcs.	1.06 ea.											
from 40 pcs.	0.96 ea.											
from 80 pcs.	0.90 ea.											
<p><b>S-20-03-N</b> Disc magnet Ø 20 mm, height 3 mm, holds approx. 4.3 kg Weight: 7.2 g Nickel-plated (Ni-Cu-Ni) Magnetisation: N45 strength: approx. 4.3 kg</p>	<p>Price in CHF</p> <table> <tr><td>5 pcs.</td><td>1.30 ea.</td></tr> <tr><td>from 15 pcs.</td><td>1.16 ea.</td></tr> <tr><td>from 40 pcs.</td><td>1.05 ea.</td></tr> <tr><td>from 80 pcs.</td><td>0.98 ea.</td></tr> </table>	5 pcs.	1.30 ea.	from 15 pcs.	1.16 ea.	from 40 pcs.	1.05 ea.	from 80 pcs.	0.98 ea.			
5 pcs.	1.30 ea.											
from 15 pcs.	1.16 ea.											
from 40 pcs.	1.05 ea.											
from 80 pcs.	0.98 ea.											
<p><b>S-20-04-N</b> Disc magnet Ø 20 mm, height 4 mm, holds approx. 5.3 kg Weight: 9.6 g Nickel-plated (Ni-Cu-Ni) Magnetisation: N42 strength: approx. 5.3 kg</p>	<p>Price in CHF</p> <table> <tr><td>1 pc.</td><td>1.95 ea.</td></tr> <tr><td>from 3 pcs.</td><td>1.70 ea.</td></tr> <tr><td>from 10 pcs.</td><td>1.50 ea.</td></tr> <tr><td>from 20 pcs.</td><td>1.40 ea.</td></tr> <tr><td>from 40 pcs.</td><td>1.30 ea.</td></tr> </table>	1 pc.	1.95 ea.	from 3 pcs.	1.70 ea.	from 10 pcs.	1.50 ea.	from 20 pcs.	1.40 ea.	from 40 pcs.	1.30 ea.	
1 pc.	1.95 ea.											
from 3 pcs.	1.70 ea.											
from 10 pcs.	1.50 ea.											
from 20 pcs.	1.40 ea.											
from 40 pcs.	1.30 ea.											
<p><b>S-20-05-T</b> Disc magnet Ø 20 mm, height 5 mm, holds approx. 6.4 kg Weight: 12 g coated with PTFE Magnetisation: N42 strength: approx. 6.4 kg</p>	<p>Price in CHF</p> <table> <tr><td>1 pc.</td><td>2.00 ea.</td></tr> <tr><td>from 3 pcs.</td><td>1.75 ea.</td></tr> <tr><td>from 10 pcs.</td><td>1.55 ea.</td></tr> <tr><td>from 20 pcs.</td><td>1.45 ea.</td></tr> <tr><td>from 40 pcs.</td><td>1.35 ea.</td></tr> </table>	1 pc.	2.00 ea.	from 3 pcs.	1.75 ea.	from 10 pcs.	1.55 ea.	from 20 pcs.	1.45 ea.	from 40 pcs.	1.35 ea.	<p>Its non-stick coating gives this disc magnet a dark-grey colour. The coating makes the magnet nearly waterproof and very abrasion-proof.</p>
1 pc.	2.00 ea.											
from 3 pcs.	1.75 ea.											
from 10 pcs.	1.55 ea.											
from 20 pcs.	1.45 ea.											
from 40 pcs.	1.35 ea.											
<p><b>S-20-05-N</b> Disc magnet Ø 20 mm, height 5 mm, holds approx. 6.4 kg Weight: 12 g Nickel-plated (Ni-Cu-Ni) Magnetisation: N42 strength: approx. 6.4 kg</p>	<p>Price in CHF</p> <table> <tr><td>1 pc.</td><td>2.15 ea.</td></tr> <tr><td>from 3 pcs.</td><td>1.90 ea.</td></tr> <tr><td>from 10 pcs.</td><td>1.70 ea.</td></tr> <tr><td>from 20 pcs.</td><td>1.55 ea.</td></tr> <tr><td>from 40 pcs.</td><td>1.45 ea.</td></tr> </table>	1 pc.	2.15 ea.	from 3 pcs.	1.90 ea.	from 10 pcs.	1.70 ea.	from 20 pcs.	1.55 ea.	from 40 pcs.	1.45 ea.	<p>If you have to keep an eye on the thickness, for example, embedding a magnet in a cabinet door, then this 5 mm thin magnet is just the thing... and it still has an impressive attractive force!</p>
1 pc.	2.15 ea.											
from 3 pcs.	1.90 ea.											
from 10 pcs.	1.70 ea.											
from 20 pcs.	1.55 ea.											
from 40 pcs.	1.45 ea.											

<b>S-20-06-N</b>		Price in CHF		
Disc magnet Ø 20 mm, height 6 mm, holds approx. 7.5 kg		1 pc.	2.40 ea.	
Weight: 14 g	from	3 pcs.	2.10 ea.	
Nickel-plated (Ni-Cu-Ni)	from	10 pcs.	1.90 ea.	
Magnetisation: N42	from	20 pcs.	1.75 ea.	
strength: approx. 7.5 kg	from	40 pcs.	1.65 ea.	
<b>S-20-07-N</b>		Price in CHF		
Disc magnet Ø 20 mm, height 7 mm, holds approx. 8.4 kg		1 pc.	3.05 ea.	
Weight: 17 g	from	3 pcs.	2.70 ea.	
Nickel-plated (Ni-Cu-Ni)	from	10 pcs.	2.35 ea.	
Magnetisation: N42	from	20 pcs.	2.20 ea.	
strength: approx. 8.4 kg	from	40 pcs.	2.05 ea.	
<b>S-20-08-N</b>		Price in CHF		
Disc magnet Ø 20 mm, height 8 mm, holds approx. 9.3 kg		1 pc.	3.25 ea.	
Weight: 19 g	from	3 pcs.	2.90 ea.	
Nickel-plated (Ni-Cu-Ni)	from	10 pcs.	2.60 ea.	
Magnetisation: N42	from	20 pcs.	2.45 ea.	
strength: approx. 9.3 kg	from	40 pcs.	2.35 ea.	
<b>S-20-09-N</b>		Price in CHF		
Disc magnet Ø 20 mm, height 9 mm, holds approx. 10 kg		1 pc.	3.65 ea.	
Weight: 21 g	from	3 pcs.	3.25 ea.	
Nickel-plated (Ni-Cu-Ni)	from	10 pcs.	2.85 ea.	
Magnetisation: N42	from	20 pcs.	2.70 ea.	
strength: approx. 10 kg	from	40 pcs.	2.55 ea.	
<b>S-20-10-N</b>		Price in CHF		Wow! With this item you definitely get the most bang for your buck! Hard core! And a very good value (such prices are almost indecent).
Disc magnet Ø 20 mm, height 10 mm, holds approx. 11 kg		1 pc.	4.10 ea.	
Weight: 24 g	from	3 pcs.	3.60 ea.	
Nickel-plated (Ni-Cu-Ni)	from	10 pcs.	3.20 ea.	
Magnetisation: N42	from	20 pcs.	3.00 ea.	
strength: approx. 11 kg	from	40 pcs.	2.80 ea.	
<b>S-20-12-N</b>		Price in CHF		
Disc magnet Ø 20 mm, height 12 mm, holds approx. 12 kg		1 pc.	4.25 ea.	
Weight: 29 g	from	3 pcs.	3.80 ea.	
Nickel-plated (Ni-Cu-Ni)	from	10 pcs.	3.40 ea.	
Magnetisation: N42	from	20 pcs.	3.20 ea.	
strength: approx. 12 kg	from	40 pcs.	3.05 ea.	
<b>S-20-15-N</b>		Price in CHF		
Disc magnet Ø 20 mm, height 15 mm, holds approx. 13 kg		1 pc.	5.55 ea.	
Weight: 36 g	from	3 pcs.	4.95 ea.	
Nickel-plated (Ni-Cu-Ni)	from	10 pcs.	4.45 ea.	
Magnetisation: N42	from	20 pcs.	4.20 ea.	
strength: approx. 13 kg	from	40 pcs.	3.95 ea.	
<b>S-20-20-N</b>		Price in CHF		
Disc magnet Ø 20 mm, height 20 mm, holds approx. 15 kg		1 pc.	6.75 ea.	
Weight: 48 g	from	3 pcs.	6.05 ea.	
Nickel-plated (Ni-Cu-Ni)	from	10 pcs.	5.45 ea.	
Magnetisation: N42	from	20 pcs.	5.15 ea.	
strength: approx. 15 kg	from	40 pcs.	4.85 ea.	
<b>S-25-02-N</b>		Price in CHF		
Disc magnet Ø 25 mm, height 2 mm, holds approx. 3.1 kg		5 pcs.	1.37 ea.	
Weight: 7.5 g	from	15 pcs.	1.22 ea.	
Nickel-plated (Ni-Cu-Ni)	from	40 pcs.	1.11 ea.	
Magnetisation: N38	from	80 pcs.	1.04 ea.	
strength: approx. 3.1 kg				



<b>S-25-03-N</b>		Price in CHF	
Disc magnet Ø 25 mm, height 3 mm, holds approx. 5.5 kg		1 pc.	2.35 ea.
Weight: 11 g	from	3 pcs.	2.10 ea.
Nickel-plated (Ni-Cu-Ni)	from	10 pcs.	1.85 ea.
Magnetisation: N45	from	20 pcs.	1.70 ea.
strength: approx. 5.5 kg	from	40 pcs.	1.60 ea.
<b>S-25-05-N</b>		Price in CHF	
Disc magnet Ø 25 mm, height 5 mm, holds approx. 8.3 kg		1 pc.	3.40 ea.
Weight: 19 g	from	3 pcs.	3.00 ea.
Nickel-plated (Ni-Cu-Ni)	from	10 pcs.	2.65 ea.
Magnetisation: N42	from	20 pcs.	2.50 ea.
strength: approx. 8.3 kg	from	40 pcs.	2.35 ea.
The S-25-05-N is a real power pack: With an adhesive force of 8.8 kg, it is suitable for both industrial and specific applications that call for extraordinary adhesive force.			
<b>S-25-07-N</b>		Price in CHF	
Disc magnet Ø 25 mm, height 7 mm, holds approx. 11 kg		1 pc.	5.15 ea.
Weight: 26 g	from	3 pcs.	4.60 ea.
Nickel-plated (Ni-Cu-Ni)	from	10 pcs.	4.10 ea.
Magnetisation: N42	from	20 pcs.	3.85 ea.
strength: approx. 11 kg	from	40 pcs.	3.60 ea.
<b>S-30-03-N</b>		Price in CHF	
Disc magnet Ø 30 mm, height 3 mm, holds approx. 6.7 kg		1 pc.	2.95 ea.
Weight: 16 g	from	3 pcs.	2.60 ea.
Nickel-plated (Ni-Cu-Ni)	from	10 pcs.	2.35 ea.
Magnetisation: N45	from	20 pcs.	2.20 ea.
strength: approx. 6.7 kg	from	40 pcs.	2.05 ea.
<b>S-30-07-N</b>		Price in CHF	
Disc magnet Ø 30 mm, height 7 mm, holds approx. 14 kg		1 pc.	6.35 ea.
Weight: 38 g	from	3 pcs.	5.65 ea.
Nickel-plated (Ni-Cu-Ni)	from	10 pcs.	5.00 ea.
Magnetisation: N42	from	20 pcs.	4.70 ea.
strength: approx. 14 kg	from	40 pcs.	4.40 ea.
<b>S-30-10-N</b>		Price in CHF	
Disc magnet Ø 30 mm, height 10 mm, holds approx. 20 kg		1 pc.	8.75 ea.
Weight: 54 g	from	3 pcs.	7.90 ea.
Nickel-plated (Ni-Cu-Ni)	from	10 pcs.	7.15 ea.
Magnetisation: N45	from	20 pcs.	6.75 ea.
strength: approx. 20 kg	from	40 pcs.	6.45 ea.
<b>S-30-15-N</b>		Price in CHF	
Disc magnet Ø 30 mm, height 15 mm, holds approx. 24 kg		1 pc.	9.70 ea.
Weight: 81 g	from	3 pcs.	8.70 ea.
Nickel-plated (Ni-Cu-Ni)	from	10 pcs.	7.85 ea.
Magnetisation: N42	from	20 pcs.	7.40 ea.
strength: approx. 24 kg	from	40 pcs.	7.05 ea.
<b>S-35-05-N</b>		Price in CHF	
Disc magnet Ø 35 mm, height 5 mm, holds approx. 12 kg		1 pc.	5.65 ea.
Weight: 37 g	from	3 pcs.	5.05 ea.
Nickel-plated (Ni-Cu-Ni)	from	10 pcs.	4.50 ea.
Magnetisation: N42	from	20 pcs.	4.25 ea.
strength: approx. 12 kg	from	40 pcs.	4.00 ea.
<b>S-35-20-N</b>		Price in CHF	
Disc magnet Ø 35 mm, height 20 mm, holds approx. 38 kg		1 pc.	20.55 ea.
Weight: 150 g	from	3 pcs.	18.60 ea.
Nickel-plated (Ni-Cu-Ni)	from	10 pcs.	16.85 ea.
Magnetisation: N45	from	20 pcs.	16.00 ea.
strength: approx. 38 kg	from	40 pcs.	15.25 ea.

<p><b>S-45-30-N</b> Disc magnet Ø 45 mm, height 30 mm, holds approx. 69 kg Weight: 360 g Nickel-plated (Ni-Cu-Ni) Magnetisation: N45 strength: approx. 69 kg</p>	<p>Price in CHF 1 pc. 45.65 ea. from 3 pcs. 41.90 ea. from 10 pcs. 38.55 ea. from 20 pcs. 36.90 ea. from 40 pcs. 35.45 ea.</p>	<p>Our second-strongest disc magnet. Given its holding power of 69 kg, one must naturally take extra care when handling these. With a diameter of 4.5 cm, this magnet hardly looks suspicious. Ah, but looks can be deceiving!</p>
<p><b>S-60-05-N</b> Disc magnet Ø 60 mm, height 5 mm, holds approx. 21 kg Weight: 110 g Nickel-plated (Ni-Cu-Ni) Magnetisation: N42 strength: approx. 21 kg</p>	<p>Price in CHF 1 pc. 16.70 ea. from 3 pcs. 15.00 ea. from 10 pcs. 13.50 ea. from 20 pcs. 12.80 ea. from 40 pcs. 12.15 ea.</p>	
<p><b>S-70-35-N</b> Disc magnet Ø 70 mm, height 35 mm, holds approx. 140 kg Weight: 1 kg Nickel-plated (Ni-Cu-Ni) Magnetisation: N45 strength: approx. 140 kg</p>	<p>Price in CHF 1 pc. 124.45 ea. from 3 pcs. 114.55 ea. from 10 pcs. 105.70 ea. from 20 pcs. 101.40 ea. from 40 pcs. 97.60 ea.</p>	<p>A power magnet full of extremes: The largest and strongest disc magnet we ever had in our assortment.</p>

## Rod magnets made of neodymium

All rod magnets have their north and south poles on the even circular surfaces (axial magnetisation). The sole exception is the S-04-10-DN, which is diametrically magnetised.

<b>S-02-03-N</b>		Price in CHF
Rod magnet Ø 2 mm, height 3 mm, holds approx. 160 g	20 pcs.	0.18 ea.
Weight: 0.072 g	from 60 pcs.	0.15 ea.
Nickel-plated (Ni-Cu-Ni)	from 140 pcs.	0.13 ea.
Magnetisation: N45	from 360 pcs.	0.11 ea.
strength: approx. 160 g		
<b>S-02-04-N</b>		Price in CHF
Rod magnet Ø 2 mm, height 4 mm, holds approx. 160 g	20 pcs.	0.19 ea.
Weight: 0.096 g	from 60 pcs.	0.16 ea.
Nickel-plated (Ni-Cu-Ni)	from 140 pcs.	0.14 ea.
Magnetisation: N45	from 360 pcs.	0.12 ea.
strength: approx. 160 g		
<b>S-02-05-N</b>		Price in CHF
Rod magnet Ø 2 mm, height 5 mm, holds approx. 170 g	20 pcs.	0.21 ea.
Weight: 0.12 g	from 60 pcs.	0.18 ea.
Nickel-plated (Ni-Cu-Ni)	from 140 pcs.	0.16 ea.
Magnetisation: N45	from 360 pcs.	0.14 ea.
strength: approx. 170 g		
<b>S-03-06-N</b>		Price in CHF
Rod magnet Ø 3 mm, height 6 mm, holds approx. 400 g	20 pcs.	0.27 ea.
Weight: 0.32 g	from 60 pcs.	0.23 ea.
Nickel-plated (Ni-Cu-Ni)	from 140 pcs.	0.20 ea.
Magnetisation: N48	from 360 pcs.	0.18 ea.
strength: approx. 400 g		
<b>S-03-08-N</b>		Price in CHF
Rod magnet Ø 3 mm, height 8 mm, holds approx. 410 g	10 pcs.	0.29 ea.
Weight: 0.43 g	from 40 pcs.	0.24 ea.
Nickel-plated (Ni-Cu-Ni)	from 80 pcs.	0.21 ea.
Magnetisation: N48	from 160 pcs.	0.19 ea.
strength: approx. 410 g		
<b>S-03-10-N</b>		Price in CHF
Rod magnet Ø 3 mm, height 10 mm, holds approx. 390 g	10 pcs.	0.36 ea.
Weight: 0.54 g	from 40 pcs.	0.29 ea.
Nickel-plated (Ni-Cu-Ni)	from 80 pcs.	0.27 ea.
Magnetisation: N45	from 160 pcs.	0.24 ea.
strength: approx. 390 g		
<b>S-04-05-Z</b>		Price in CHF
Rod magnet Ø 4 mm, height 5 mm, holds approx. 630 g	20 pcs.	0.29 ea.
Weight: 0.48 g	from 60 pcs.	0.24 ea.
Zinc-plated (Ni-Cu-Ni-Zn)	from 140 pcs.	0.22 ea.
Magnetisation: N45	from 360 pcs.	0.19 ea.
strength: approx. 630 g		
A small zinc-plated rod magnet: In addition to the normal Ni-Cu-Ni coating a layer of zinc is added, which gives the rod magnet a slightly blue and matt hue.		
<b>S-04-07-N</b>		Price in CHF
Rod magnet Ø 4 mm, height 7 mm, holds approx. 670 g	10 pcs.	0.34 ea.
Weight: 0.67 g	from 40 pcs.	0.28 ea.
Nickel-plated (Ni-Cu-Ni)	from 80 pcs.	0.25 ea.
Magnetisation: N45	from 160 pcs.	0.23 ea.
strength: approx. 670 g		

<p><b>S-04-10-AN</b> Rod magnet Ø 4 mm, height 10 mm, holds approx. 700 g Weight: 0.96 g Nickel-plated (Ni-Cu-Ni) Magnetisation: N45 strength: approx. 700 g</p>	<p>Price in CHF</p> <p>5 pcs. 0.48 ea. from 15 pcs. 0.41 ea. from 40 pcs. 0.36 ea. from 80 pcs. 0.33 ea.</p>	<p>These rod magnets axially magnetised.</p>
<p><b>S-04-10-DN</b> Rod magnet Ø 4 mm, height 10 mm, holds approx. 1.1 kg Weight: 0.96 g Nickel-plated (Ni-Cu-Ni) Magnetisation: N45 strength: approx. 1.1 kg</p>	<p>Price in CHF</p> <p>10 pcs. 0.43 ea. from 40 pcs. 0.35 ea. from 80 pcs. 0.32 ea. from 160 pcs. 0.30 ea.</p>	<p>Please note: This rod magnet is diametrically magnetised. This means that these rods will not join end-to-end lengthwise, but rather side-by-side, like fish fingers.</p>
<p><b>S-04-13-N</b> Rod magnet Ø 4 mm, height 12.5 mm, holds approx. 660 g Weight: 1.2 g Nickel-plated (Ni-Cu-Ni) Magnetisation: N42 strength: approx. 660 g</p>	<p>Price in CHF</p> <p>10 pcs. 0.46 ea. from 40 pcs. 0.38 ea. from 80 pcs. 0.35 ea. from 160 pcs. 0.32 ea.</p>	<p>Small rod magnet, exactly half as long as the S-04-25-N.</p>
<p><b>S-04-25-N</b> Rod magnet Ø 4 mm, height 25 mm, holds approx. 670 g Weight: 2.4 g Nickel-plated (Ni-Cu-Ni) Magnetisation: N42 strength: approx. 670 g</p>	<p>Price in CHF</p> <p>5 pcs. 0.75 ea. from 15 pcs. 0.65 ea. from 40 pcs. 0.58 ea. from 80 pcs. 0.54 ea.</p>	<p>This slim rod magnet is wonderfully suitable for combining with steel spheres.</p>
<p><b>S-05-08-N</b> Rod magnet Ø 5 mm, height 8.47 mm, holds approx. 1.1 kg Weight: 1.3 g Nickel-plated (Ni-Cu-Ni) Magnetisation: N45 strength: approx. 1.1 kg</p>	<p>Price in CHF</p> <p>10 pcs. 0.45 ea. from 40 pcs. 0.37 ea. from 80 pcs. 0.34 ea. from 160 pcs. 0.31 ea.</p>	<p>Very small, strong rod magnet. This magnet is especially suitable as a fridge magnet, for use on a magnetic board, or on a magnetic strip. It has an enormous adhesive force and is also comfortable to hold.</p>
<p><b>S-05-10-N</b> Rod magnet Ø 5 mm, height 10 mm, holds approx. 1.1 kg Weight: 1.5 g Nickel-plated (Ni-Cu-Ni) Magnetisation: N45 strength: approx. 1.1 kg</p>	<p>Price in CHF</p> <p>10 pcs. 0.45 ea. from 40 pcs. 0.38 ea. from 80 pcs. 0.35 ea. from 160 pcs. 0.32 ea.</p>	
<p><b>S-05-13-N</b> Rod magnet Ø 5 mm, height 12.5 mm, holds approx. 1.1 kg Weight: 1.9 g Nickel-plated (Ni-Cu-Ni) Magnetisation: N45 strength: approx. 1.1 kg</p>	<p>Price in CHF</p> <p>5 pcs. 0.63 ea. from 15 pcs. 0.54 ea. from 40 pcs. 0.48 ea. from 80 pcs. 0.44 ea.</p>	<p>Rod magnet, exactly half as long as S-05-25-N - in this photo, made into a tetrahedron combined with steel spheres.</p>
<p><b>S-05-14-N</b> Rod magnet Ø 5 mm, height 13.96 mm, holds approx. 1.1 kg Weight: 2.1 g Nickel-plated (Ni-Cu-Ni) Magnetisation: N45 strength: approx. 1.1 kg</p>	<p>Price in CHF</p> <p>5 pcs. 0.68 ea. from 15 pcs. 0.59 ea. from 40 pcs. 0.53 ea. from 80 pcs. 0.48 ea.</p>	
<p><b>S-05-25-N</b> Rod magnet Ø 5 mm, height 25 mm, holds approx. 1.1 kg Weight: 3.7 g Nickel-plated (Ni-Cu-Ni) Magnetisation: N45 strength: approx. 1.1 kg</p>	<p>Price in CHF</p> <p>5 pcs. 0.93 ea. from 15 pcs. 0.82 ea. from 40 pcs. 0.73 ea. from 80 pcs. 0.68 ea.</p>	

<p><b>S-06-08-N</b> Rod magnet Ø 6 mm, height 8 mm, holds approx. 1.6 kg Weight: 1.7 g Nickel-plated (Ni-Cu-Ni) Magnetisation: N48 strength: approx. 1.6 kg</p>	<p>Price in CHF</p> <p>5 pcs. 0.65 ea. from 15 pcs. 0.57 ea. from 40 pcs. 0.50 ea. from 80 pcs. 0.46 ea.</p>	
<p><b>S-06-10-N</b> Rod magnet Ø 6 mm, height 10 mm, holds approx. 1.4 kg Weight: 2.1 g Nickel-plated (Ni-Cu-Ni) Magnetisation: N40 strength: approx. 1.4 kg</p>	<p>Price in CHF</p> <p>5 pcs. 0.62 ea. from 15 pcs. 0.54 ea. from 40 pcs. 0.47 ea. from 80 pcs. 0.44 ea.</p>	<p>These neodymium rod magnets are already quite powerful with an adhesive force of approx. 1.4 kg. However, thanks to their shape, they are easy to grip and comfortable to hold.</p>
<p><b>S-06-13-N</b> Rod magnet Ø 6 mm, height 13 mm, holds approx. 1.7 kg Weight: 2.8 g Nickel-plated (Ni-Cu-Ni) Magnetisation: N48 strength: approx. 1.7 kg</p>	<p>Price in CHF</p> <p>5 pcs. 0.81 ea. from 15 pcs. 0.70 ea. from 40 pcs. 0.63 ea. from 80 pcs. 0.58 ea.</p>	<p>Extra strong, small rod magnet. It is wonderfully suitable for attaching paper to a magnetic board or magnetic strip in a very secure and elegant manner.</p>
<p><b>S-06-25-N</b> Rod magnet Ø 6.35 mm, height 25.4 mm, holds approx. 1.7 kg Weight: 6.1 g Nickel-plated (Ni-Cu-Ni) Magnetisation: N42 strength: approx. 1.7 kg</p>	<p>Price in CHF</p> <p>5 pcs. 1.48 ea. from 15 pcs. 1.31 ea. from 40 pcs. 1.18 ea. from 80 pcs. 1.10 ea.</p>	<p>Strong rod magnets, shown in this photo with a steel ball ST-K-13-N in the centre. Each of these rod magnets is so strong that it can easily lift 80 other rod magnets.</p>
<p><b>S-08-30-N</b> Rod magnet Ø 8 mm, height 30 mm, holds approx. 2.7 kg Weight: 11 g Nickel-plated (Ni-Cu-Ni) Magnetisation: N42 strength: approx. 2.7 kg</p>	<p>Price in CHF</p> <p>1 pc. 2.65 ea. from 3 pcs. 2.30 ea. from 10 pcs. 2.00 ea. from 20 pcs. 1.85 ea. from 40 pcs. 1.75 ea.</p>	
<p><b>S-10-20-N</b> Rod magnet Ø 10 mm, height 20 mm, holds approx. 4.4 kg Weight: 12 g Nickel-plated (Ni-Cu-Ni) Magnetisation: N45 strength: approx. 4.4 kg</p>	<p>Price in CHF</p> <p>1 pc. 2.80 ea. from 3 pcs. 2.45 ea. from 10 pcs. 2.15 ea. from 20 pcs. 2.00 ea. from 40 pcs. 1.85 ea.</p>	
<p><b>S-10-40-N</b> Rod magnet Ø 10 mm, height 40 mm, holds approx. 4.1 kg Weight: 24 g Nickel-plated (Ni-Cu-Ni) Magnetisation: N40 strength: approx. 4.1 kg</p>	<p>Price in CHF</p> <p>1 pc. 4.15 ea. from 3 pcs. 3.70 ea. from 10 pcs. 3.30 ea. from 20 pcs. 3.10 ea. from 40 pcs. 2.95 ea.</p>	
<p><b>S-12-60-N</b> Rod magnet Ø 12 mm, height 60 mm, holds approx. 5.6 kg Weight: 52 g Nickel-plated (Ni-Cu-Ni) Magnetisation: N38 strength: approx. 5.6 kg</p>	<p>Price in CHF</p> <p>1 pc. 11.35 ea. from 3 pcs. 10.05 ea. from 10 pcs. 8.90 ea. from 20 pcs. 8.35 ea. from 40 pcs. 7.85 ea.</p>	
<p><b>S-15-100-N</b> Rod magnet Ø 15 mm, height 100 mm, holds approx. 8.2 kg Weight: 130 g Nickel-plated (Ni-Cu-Ni) Magnetisation: N35 strength: approx. 8.2 kg</p>	<p>Price in CHF</p> <p>1 pc. 34.65 ea. from 3 pcs. 31.10 ea. from 10 pcs. 27.90 ea. from 20 pcs. 26.35 ea. from 40 pcs. 24.95 ea.</p>	<p>Giant rod magnet. The poles are located on the even circular areas. The classic model for the old school experiment with iron filings.</p>

## Block magnets neodymium

<p><b>Q-05-1.5-01-N</b> Block magnet 5 x 1.5 x 1 mm, holds approx. 140 g Weight: 0.057 g Nickel-plated (Ni-Cu-Ni) Magnetisation: N45 strength: approx. 140 g</p>	<p>Price in CHF</p> <p>20 pcs. 0.20 ea. from 60 pcs. 0.16 ea. from 140 pcs. 0.14 ea. from 360 pcs. 0.12 ea.</p>	<p>Although this magnet is capable of securing a piece of A4 paper or a business card to the wall, it's not really suitable for these tasks. Model builders are much happier to use this magnet in tuning their engines.</p>
<p><b>Q-05-2.5-1.5-HN</b> Block magnet 5 x 2.5 x 1.5 mm, holds approx. 350 g Weight: 0.14 g Nickel-plated (Ni-Cu-Ni) Magnetisation: 44H strength: approx. 350 g</p>	<p>Price in CHF</p> <p>20 pcs. 0.24 ea. from 60 pcs. 0.20 ea. from 140 pcs. 0.18 ea. from 360 pcs. 0.15 ea.</p>	<p>Some model plane motors get so hot that this magnet must be used: It keeps its magnetisation at temperatures up to 120 degrees Celsius.</p>
<p><b>Q-05-2.5-02-HN</b> Block magnet 5 x 2.5 x 2 mm, holds approx. 450 g Weight: 0.19 g Nickel-plated (Ni-Cu-Ni) Magnetisation: 44H strength: approx. 450 g</p>	<p>Price in CHF</p> <p>20 pcs. 0.24 ea. from 60 pcs. 0.20 ea. from 140 pcs. 0.18 ea. from 360 pcs. 0.15 ea.</p>	<p>This magnet can also be used at temperatures up to 120 degrees Celsius.</p>
<p><b>Q-05-04-01-G</b> Block magnet 5 x 4 x 1 mm, holds approx. 350 g Weight: 0.15 g Gold-plated (Ni-Cu-Ni-Au) Magnetisation: N50 strength: approx. 350 g</p>	<p>Price in CHF</p> <p>20 pcs. 0.23 ea. from 60 pcs. 0.19 ea. from 140 pcs. 0.16 ea. from 360 pcs. 0.14 ea.</p>	<p>A tiny magnet with a strong N50 magnetisation. This gold-plated block magnet is perfect for model plane builders, inventors and creative minds.</p>
<p><b>Q-05-04-01-N</b> Block magnet 5 x 4 x 1 mm, holds approx. 350 g Weight: 0.15 g Nickel-plated (Ni-Cu-Ni) Magnetisation: N50 strength: approx. 350 g</p>	<p>Price in CHF</p> <p>20 pcs. 0.24 ea. from 60 pcs. 0.20 ea. from 140 pcs. 0.18 ea. from 360 pcs. 0.15 ea.</p>	
<p><b>Q-05-04-1.5-N</b> Block magnet 5 x 4 x 1.5 mm, holds approx. 500 g Weight: 0.23 g Nickel-plated (Ni-Cu-Ni) Magnetisation: N48 strength: approx. 500 g</p>	<p>Price in CHF</p> <p>20 pcs. 0.27 ea. from 60 pcs. 0.22 ea. from 140 pcs. 0.20 ea. from 360 pcs. 0.17 ea.</p>	<p>This block magnet is perfect for model making. With its dimensions of 5 x 4 x 1.5 mm, the magnet is a good size for model aeroplanes.</p>
<p><b>Q-05-05-01-HN</b> Block magnet 5 x 5 x 1 mm, holds approx. 350 g Weight: 0.19 g Nickel-plated (Ni-Cu-Ni) Magnetisation: 44H strength: approx. 350 g</p>	<p>Price in CHF</p> <p>20 pcs. 0.24 ea. from 60 pcs. 0.20 ea. from 140 pcs. 0.18 ea. from 360 pcs. 0.15 ea.</p>	<p>This magnet can be used at temperatures of up to 120 degrees Celsius, as opposed to most of the other magnets on this website, which can be used at a maximum of 80 degrees Celsius. Interesting for model plane builders.</p>
<p><b>Q-CDM48-G</b> Block magnet 5 x 5 x 1 mm, holds approx. 350 g Weight: 0.19 g Gold-plated (Ni-Cu-Ni-Au) Magnetisation: N48 strength: approx. 350 g</p>	<p>Price in CHF</p> <p>20 pcs. 0.25 ea. from 60 pcs. 0.21 ea. from 140 pcs. 0.18 ea. from 360 pcs. 0.16 ea.</p>	<p>We produced this magnet especially for the CD-ROM model airplane engine do-it-yourselfers. Naturally, there are lots of other uses for this small gold-plated magnet. It holds, for example, 2-3 pieces of A4 paper.</p>

<p><b>Q-CDM48-N</b> Block magnet 5 x 5 x 1 mm, holds approx. 350 g Weight: 0.19 g Nickel-plated (Ni-Cu-Ni) Magnetisation: N48 strength: approx. 350 g</p>	<p>Price in CHF</p> <p>20 pcs. 0.25 ea. from 60 pcs. 0.21 ea. from 140 pcs. 0.18 ea. from 360 pcs. 0.16 ea.</p>	<p>This very small block magnet holds, for instance, 2-3 A4 sheets. It looks really good when you use 2 or 4 magnets per sheet. Very discreet with only 1 mm thickness.</p>
<p><b>Q-CDM50-G</b> Block magnet 5 x 5 x 1.2 mm, holds approx. 450 g Weight: 0.23 g Gold-plated (Ni-Cu-Ni-Au) Magnetisation: N50 strength: approx. 450 g</p>	<p>Price in CHF</p> <p>20 pcs. 0.30 ea. from 60 pcs. 0.26 ea. from 140 pcs. 0.22 ea. from 360 pcs. 0.19 ea.</p>	<p>And here we have the ultimate CD-ROM model airplane engine do-it-yourself magnet! Due to high demand, we made this magnet a bit thicker (1.2 mm instead of 1.0 mm) and increased the magnetisation a bit (N50 instead of N48).</p>
<p><b>Q-CDM50-N</b> Block magnet 5 x 5 x 1.2 mm, holds approx. 450 g Weight: 0.23 g Nickel-plated (Ni-Cu-Ni) Magnetisation: N50 strength: approx. 450 g</p>	<p>Price in CHF</p> <p>20 pcs. 0.27 ea. from 60 pcs. 0.23 ea. from 140 pcs. 0.20 ea. from 360 pcs. 0.17 ea.</p>	<p>Small block magnet with especially high magnetisation N50.</p>
<p><b>Q-05-05-02-G</b> Block magnet 5 x 5 x 2 mm, holds approx. 650 g Weight: 0.38 g Gold-plated (Ni-Cu-Ni-Au) Magnetisation: N45 strength: approx. 650 g</p>	<p>Price in CHF</p> <p>10 pcs. 0.35 ea. from 40 pcs. 0.28 ea. from 80 pcs. 0.26 ea. from 160 pcs. 0.23 ea.</p>	<p>Extra strong (N45) and plated with real gold! Ideal for stylish posting of notes. Holds 7 pieces of A4 paper to a metal sheet! The adhesive force on a piece of steel is over 1/2 kg!</p>
<p><b>Q-05-05-02-N</b> Block magnet 5 x 5 x 2 mm, holds approx. 650 g Weight: 0.38 g Nickel-plated (Ni-Cu-Ni) Magnetisation: N45 strength: approx. 650 g</p>	<p>Price in CHF</p> <p>10 pcs. 0.34 ea. from 40 pcs. 0.27 ea. from 80 pcs. 0.25 ea. from 160 pcs. 0.22 ea.</p>	<p>Small block magnet with N45 magnetisation. A stylish way to attach your notes - holds 7 sheets of A4 paper on a metal surface!</p>
<p><b>Q-05-05-03-N52N</b> Block magnet 5 x 5 x 3 mm, holds approx. 1 kg Weight: 0.57 g Nickel-plated (Ni-Cu-Ni) Magnetisation: N52 strength: approx. 1 kg</p>	<p>Price in CHF</p> <p>10 pcs. 0.38 ea. from 40 pcs. 0.31 ea. from 80 pcs. 0.28 ea. from 160 pcs. 0.25 ea.</p>	<p>Thanks to the extremely strong N52 magnetisation, this small block magnet features an adhesive force of 1 kg.</p>
<p><b>Q-06-04-02-HN</b> Block magnet 6 x 4 x 2 mm, holds approx. 640 g Weight: 0.36 g Nickel-plated (Ni-Cu-Ni) Magnetisation: 44H strength: approx. 640 g</p>	<p>Price in CHF</p> <p>10 pcs. 0.29 ea. from 40 pcs. 0.23 ea. from 80 pcs. 0.20 ea. from 160 pcs. 0.18 ea.</p>	<p>Temperature resistant to 120 degrees Celsius.</p>
<p><b>Q-06-05-02-HN</b> Block magnet 6 x 5 x 2 mm, holds approx. 600 g Weight: 0.46 g Nickel-plated (Ni-Cu-Ni) Magnetisation: 48H strength: approx. 600 g</p>	<p>Price in CHF</p> <p>20 pcs. 0.31 ea. from 60 pcs. 0.26 ea. from 140 pcs. 0.23 ea. from 360 pcs. 0.20 ea.</p>	<p>Temperature-resistant to 120 degrees Celsius. Perfect for model making.</p>
<p><b>Q-07-06-1.2-G</b> Block magnet 7 x 6 x 1.2 mm, holds approx. 600 g Weight: 0.38 g Gold-plated (Ni-Cu-Ni-Au) Magnetisation: N50 strength: approx. 600 g</p>	<p>Price in CHF</p> <p>20 pcs. 0.30 ea. from 60 pcs. 0.25 ea. from 140 pcs. 0.22 ea. from 360 pcs. 0.20 ea.</p>	

<p><b>Q-07-06-1.2-N</b> Block magnet 7 x 6 x 1.2 mm, holds approx. 600 g Weight: 0.38 g Nickel-plated (Ni-Cu-Ni) Magnetisation: N50 strength: approx. 600 g</p>	<p>Price in CHF</p> <p>20 pcs. 0.31 ea. from 60 pcs. 0.26 ea. from 140 pcs. 0.23 ea. from 360 pcs. 0.20 ea.</p>	
<p><b>Q-08-04-03-N</b> Block magnet 8 x 4 x 3 mm, holds approx. 900 g Weight: 0.73 g Nickel-plated (Ni-Cu-Ni) Magnetisation: N45 strength: approx. 900 g</p>	<p>Price in CHF</p> <p>20 pcs. 0.33 ea. from 60 pcs. 0.28 ea. from 140 pcs. 0.25 ea. from 360 pcs. 0.22 ea.</p>	
<p><b>Q-08-05-05-Z</b> Block magnet 8 x 5 x 5 mm, holds approx. 1.1 kg Weight: 1.5 g Zinc-plated (Zn) Magnetisation: N45 strength: approx. 1.1 kg</p>	<p>Price in CHF</p> <p>10 pcs. 0.44 ea. from 40 pcs. 0.36 ea. from 80 pcs. 0.33 ea. from 160 pcs. 0.30 ea.</p>	<p>Contrary to our standard articles, these block magnets are made of zinc and not nickel-coated. Zinc gives them a slightly blue and matt appearance.</p>
<p><b>Q-08-08-04-N</b> Block magnet 8 x 8 x 4 mm, holds approx. 1.5 kg Weight: 1.9 g Nickel-plated (Ni-Cu-Ni) Magnetisation: N45 strength: approx. 1.5 kg</p>	<p>Price in CHF</p> <p>5 pcs. 0.65 ea. from 15 pcs. 0.56 ea. from 40 pcs. 0.50 ea. from 80 pcs. 0.46 ea.</p>	
<p><b>Q-10-03-02-HN</b> Block magnet 10 x 3 x 2 mm, holds approx. 700 g Weight: 0.46 g Nickel-plated (Ni-Cu-Ni) Magnetisation: 44H strength: approx. 700 g</p>	<p>Price in CHF</p> <p>10 pcs. 0.36 ea. from 40 pcs. 0.30 ea. from 80 pcs. 0.27 ea. from 160 pcs. 0.25 ea.</p>	<p>Up to 120 degrees Celsius. This magnet is often used by model airplane enthusiasts who construct their own engines. The stronger the magnet, the smaller and lighter the engine can be made.</p>
<p><b>Q-10-04-01-G</b> Block magnet 10 x 4 x 1 mm, holds approx. 580 g Weight: 0.3 g Gold-plated (Ni-Cu-Ni-Au) Magnetisation: N50 strength: approx. 580 g</p>	<p>Price in CHF</p> <p>20 pcs. 0.30 ea. from 60 pcs. 0.25 ea. from 140 pcs. 0.22 ea. from 360 pcs. 0.20 ea.</p>	
<p><b>Q-10-04-01-N</b> Block magnet 10 x 4 x 1 mm, holds approx. 580 g Weight: 0.3 g Nickel-plated (Ni-Cu-Ni) Magnetisation: N50 strength: approx. 580 g</p>	<p>Price in CHF</p> <p>20 pcs. 0.30 ea. from 60 pcs. 0.25 ea. from 140 pcs. 0.22 ea. from 360 pcs. 0.19 ea.</p>	
<p><b>Q-10-04-1.2-G</b> Block magnet 10 x 4 x 1.2 mm, holds approx. 700 g Weight: 0.36 g Gold-plated (Ni-Cu-Ni-Au) Magnetisation: N50 strength: approx. 700 g</p>	<p>Price in CHF</p> <p>20 pcs. 0.30 ea. from 60 pcs. 0.25 ea. from 140 pcs. 0.22 ea. from 360 pcs. 0.20 ea.</p>	
<p><b>Q-10-04-1.2-N</b> Block magnet 10 x 4 x 1.2 mm, holds approx. 700 g Weight: 0.36 g Nickel-plated (Ni-Cu-Ni) Magnetisation: N50 strength: approx. 700 g</p>	<p>Price in CHF</p> <p>20 pcs. 0.32 ea. from 60 pcs. 0.27 ea. from 140 pcs. 0.24 ea. from 360 pcs. 0.21 ea.</p>	



<p><b>Q-10-04-1.5-G</b> Block magnet 10 x 4 x 1.5 mm, holds approx. 900 g Weight: 0.46 g Gold-plated (Ni-Cu-Ni-Au) Magnetisation: N50 strength: approx. 900 g</p>	<p>Price in CHF</p> <p>20 pcs. 0.34 ea. from 60 pcs. 0.29 ea. from 140 pcs. 0.25 ea. from 360 pcs. 0.22 ea.</p>
<p><b>Q-10-04-1.5-N</b> Block magnet 10 x 4 x 1.5 mm, holds approx. 900 g Weight: 0.46 g Nickel-plated (Ni-Cu-Ni) Magnetisation: N50 strength: approx. 900 g</p>	<p>Price in CHF</p> <p>20 pcs. 0.30 ea. from 60 pcs. 0.25 ea. from 140 pcs. 0.22 ea. from 360 pcs. 0.19 ea.</p>
<p><b>Q-10-04-02-G</b> Block magnet 10 x 4 x 2 mm, holds approx. 1.1 kg Weight: 0.61 g Gold-plated (Ni-Cu-Ni-Au) Magnetisation: N50 strength: approx. 1.1 kg</p>	<p>Price in CHF</p> <p>10 pcs. 0.45 ea. from 40 pcs. 0.37 ea. from 80 pcs. 0.34 ea. from 160 pcs. 0.31 ea.</p>
<p><b>Q-10-04-02-N</b> Block magnet 10 x 4 x 2 mm, holds approx. 1.1 kg Weight: 0.61 g Nickel-plated (Ni-Cu-Ni) Magnetisation: N50 strength: approx. 1.1 kg</p>	<p>Price in CHF</p> <p>20 pcs. 0.32 ea. from 60 pcs. 0.27 ea. from 140 pcs. 0.24 ea. from 360 pcs. 0.21 ea.</p>
<p><b>Q-10-05-01-G</b> Block magnet 10 x 5 x 1 mm, holds approx. 650 g Weight: 0.38 g Gold-plated (Ni-Cu-Ni-Au) Magnetisation: N50 strength: approx. 650 g</p>	<p>Price in CHF</p> <p>20 pcs. 0.32 ea. from 60 pcs. 0.28 ea. from 140 pcs. 0.24 ea. from 360 pcs. 0.21 ea.</p>
<p><b>Q-10-05-01-N</b> Block magnet 10 x 5 x 1 mm, holds approx. 650 g Weight: 0.38 g Nickel-plated (Ni-Cu-Ni) Magnetisation: N50 strength: approx. 650 g</p>	<p>Price in CHF</p> <p>20 pcs. 0.32 ea. from 60 pcs. 0.27 ea. from 140 pcs. 0.24 ea. from 360 pcs. 0.21 ea.</p>
<p><b>Q-10-05-1.2-G</b> Block magnet 10 x 5 x 1.2 mm, holds approx. 800 g Weight: 0.46 g Gold-plated (Ni-Cu-Ni-Au) Magnetisation: N50 strength: approx. 800 g</p>	<p>Price in CHF</p> <p>20 pcs. 0.34 ea. from 60 pcs. 0.29 ea. from 140 pcs. 0.25 ea. from 360 pcs. 0.22 ea.</p>
<p><b>Q-10-05-1.2-N</b> Block magnet 10 x 5 x 1.2 mm, holds approx. 800 g Weight: 0.46 g Nickel-plated (Ni-Cu-Ni) Magnetisation: N50 strength: approx. 800 g</p>	<p>Price in CHF</p> <p>20 pcs. 0.32 ea. from 60 pcs. 0.27 ea. from 140 pcs. 0.24 ea. from 360 pcs. 0.21 ea.</p>
<p><b>Q-10-05-1.5-G</b> Block magnet 10 x 5 x 1.5 mm, holds approx. 980 g Weight: 0.57 g Gold-plated (Ni-Cu-Ni-Au) Magnetisation: N50 strength: approx. 980 g</p>	<p>Price in CHF</p> <p>20 pcs. 0.41 ea. from 60 pcs. 0.35 ea. from 140 pcs. 0.31 ea. from 360 pcs. 0.27 ea.</p>

<p><b>Q-10-05-1.5-N</b> Block magnet 10 x 5 x 1.5 mm, holds approx. 980 g Weight: 0.57 g Nickel-plated (Ni-Cu-Ni) Magnetisation: N50 strength: approx. 980 g</p>	<p>Price in CHF</p> <table> <tr><td>10 pcs.</td><td>0.42 ea.</td></tr> <tr><td>from 40 pcs.</td><td>0.34 ea.</td></tr> <tr><td>from 80 pcs.</td><td>0.31 ea.</td></tr> <tr><td>from 160 pcs.</td><td>0.28 ea.</td></tr> </table>	10 pcs.	0.42 ea.	from 40 pcs.	0.34 ea.	from 80 pcs.	0.31 ea.	from 160 pcs.	0.28 ea.	
10 pcs.	0.42 ea.									
from 40 pcs.	0.34 ea.									
from 80 pcs.	0.31 ea.									
from 160 pcs.	0.28 ea.									
<p><b>Q-10-05-02-G</b> Block magnet 10 x 5 x 2 mm, holds approx. 1.2 kg Weight: 0.76 g Gold-plated (Ni-Cu-Ni-Au) Magnetisation: N50 strength: approx. 1.2 kg</p>	<p>Price in CHF</p> <table> <tr><td>10 pcs.</td><td>0.42 ea.</td></tr> <tr><td>from 40 pcs.</td><td>0.34 ea.</td></tr> <tr><td>from 80 pcs.</td><td>0.31 ea.</td></tr> <tr><td>from 160 pcs.</td><td>0.28 ea.</td></tr> </table>	10 pcs.	0.42 ea.	from 40 pcs.	0.34 ea.	from 80 pcs.	0.31 ea.	from 160 pcs.	0.28 ea.	
10 pcs.	0.42 ea.									
from 40 pcs.	0.34 ea.									
from 80 pcs.	0.31 ea.									
from 160 pcs.	0.28 ea.									
<p><b>Q-10-05-02-N</b> Block magnet 10 x 5 x 2 mm, holds approx. 1.2 kg Weight: 0.76 g Nickel-plated (Ni-Cu-Ni) Magnetisation: N50 strength: approx. 1.2 kg</p>	<p>Price in CHF</p> <table> <tr><td>10 pcs.</td><td>0.45 ea.</td></tr> <tr><td>from 40 pcs.</td><td>0.37 ea.</td></tr> <tr><td>from 80 pcs.</td><td>0.33 ea.</td></tr> <tr><td>from 160 pcs.</td><td>0.30 ea.</td></tr> </table>	10 pcs.	0.45 ea.	from 40 pcs.	0.37 ea.	from 80 pcs.	0.33 ea.	from 160 pcs.	0.30 ea.	
10 pcs.	0.45 ea.									
from 40 pcs.	0.37 ea.									
from 80 pcs.	0.33 ea.									
from 160 pcs.	0.30 ea.									
<p><b>Q-10-05-03-N</b> Block magnet 10 x 5 x 3 mm, holds approx. 1.5 kg Weight: 1.1 g Nickel-plated (Ni-Cu-Ni) Magnetisation: N45 strength: approx. 1.5 kg</p>	<p>Price in CHF</p> <table> <tr><td>10 pcs.</td><td>0.46 ea.</td></tr> <tr><td>from 40 pcs.</td><td>0.38 ea.</td></tr> <tr><td>from 80 pcs.</td><td>0.35 ea.</td></tr> <tr><td>from 160 pcs.</td><td>0.32 ea.</td></tr> </table>	10 pcs.	0.46 ea.	from 40 pcs.	0.38 ea.	from 80 pcs.	0.35 ea.	from 160 pcs.	0.32 ea.	
10 pcs.	0.46 ea.									
from 40 pcs.	0.38 ea.									
from 80 pcs.	0.35 ea.									
from 160 pcs.	0.32 ea.									
<p><b>Q-10-06-06-Z</b> Block magnet 10 x 6 x 6 mm, holds approx. 2.1 kg Weight: 2.7 g Zinc-plated (Zn) Magnetisation: N45 strength: approx. 2.1 kg</p>	<p>Price in CHF</p> <table> <tr><td>5 pcs.</td><td>0.81 ea.</td></tr> <tr><td>from 15 pcs.</td><td>0.70 ea.</td></tr> <tr><td>from 40 pcs.</td><td>0.63 ea.</td></tr> <tr><td>from 80 pcs.</td><td>0.58 ea.</td></tr> </table>	5 pcs.	0.81 ea.	from 15 pcs.	0.70 ea.	from 40 pcs.	0.63 ea.	from 80 pcs.	0.58 ea.	<p>Contrary to our standard articles, these block magnets are made of zinc and not nickel-coated. Zinc gives them a slightly blue and matt appearance.</p>
5 pcs.	0.81 ea.									
from 15 pcs.	0.70 ea.									
from 40 pcs.	0.63 ea.									
from 80 pcs.	0.58 ea.									
<p><b>Q-10-10-01-N</b> Block magnet 10 x 10 x 1 mm, holds approx. 600 g Weight: 0.76 g Nickel-plated (Ni-Cu-Ni) Magnetisation: N42 strength: approx. 600 g</p>	<p>Price in CHF</p> <table> <tr><td>10 pcs.</td><td>0.49 ea.</td></tr> <tr><td>from 40 pcs.</td><td>0.40 ea.</td></tr> <tr><td>from 80 pcs.</td><td>0.36 ea.</td></tr> <tr><td>from 160 pcs.</td><td>0.33 ea.</td></tr> </table>	10 pcs.	0.49 ea.	from 40 pcs.	0.40 ea.	from 80 pcs.	0.36 ea.	from 160 pcs.	0.33 ea.	
10 pcs.	0.49 ea.									
from 40 pcs.	0.40 ea.									
from 80 pcs.	0.36 ea.									
from 160 pcs.	0.33 ea.									
<p><b>Q-10-10-1.2-N52N</b> Block magnet 10 x 10 x 1.2 mm, holds approx. 1 kg Weight: 0.91 g Nickel-plated (Ni-Cu-Ni) Magnetisation: N52 strength: approx. 1 kg</p>	<p>Price in CHF</p> <table> <tr><td>10 pcs.</td><td>0.54 ea.</td></tr> <tr><td>from 40 pcs.</td><td>0.44 ea.</td></tr> <tr><td>from 80 pcs.</td><td>0.40 ea.</td></tr> <tr><td>from 160 pcs.</td><td>0.37 ea.</td></tr> </table>	10 pcs.	0.54 ea.	from 40 pcs.	0.44 ea.	from 80 pcs.	0.40 ea.	from 160 pcs.	0.37 ea.	<p>Thanks to its extremely strong N52 magnetisation, this very flat block magnet has an adhesive force of 1 kg.</p>
10 pcs.	0.54 ea.									
from 40 pcs.	0.44 ea.									
from 80 pcs.	0.40 ea.									
from 160 pcs.	0.37 ea.									
<p><b>Q-10-10-02-N</b> Block magnet 10 x 10 x 2 mm, holds approx. 1 kg Weight: 1.5 g Nickel-plated (Ni-Cu-Ni) Magnetisation: N45 strength: approx. 1 kg</p>	<p>Price in CHF</p> <table> <tr><td>10 pcs.</td><td>0.52 ea.</td></tr> <tr><td>from 40 pcs.</td><td>0.43 ea.</td></tr> <tr><td>from 80 pcs.</td><td>0.39 ea.</td></tr> <tr><td>from 160 pcs.</td><td>0.36 ea.</td></tr> </table>	10 pcs.	0.52 ea.	from 40 pcs.	0.43 ea.	from 80 pcs.	0.39 ea.	from 160 pcs.	0.36 ea.	
10 pcs.	0.52 ea.									
from 40 pcs.	0.43 ea.									
from 80 pcs.	0.39 ea.									
from 160 pcs.	0.36 ea.									
<p><b>Q-10-10-03-N</b> Block magnet 10 x 10 x 3 mm, holds approx. 1.7 kg Weight: 2.3 g Nickel-plated (Ni-Cu-Ni) Magnetisation: N42 strength: approx. 1.7 kg</p>	<p>Price in CHF</p> <table> <tr><td>5 pcs.</td><td>0.65 ea.</td></tr> <tr><td>from 15 pcs.</td><td>0.56 ea.</td></tr> <tr><td>from 40 pcs.</td><td>0.50 ea.</td></tr> <tr><td>from 80 pcs.</td><td>0.46 ea.</td></tr> </table>	5 pcs.	0.65 ea.	from 15 pcs.	0.56 ea.	from 40 pcs.	0.50 ea.	from 80 pcs.	0.46 ea.	
5 pcs.	0.65 ea.									
from 15 pcs.	0.56 ea.									
from 40 pcs.	0.50 ea.									
from 80 pcs.	0.46 ea.									

<p><b>Q-10-10-04-K</b> Block magnet 10 x 10 x 4 mm, holds approx. 2.2 kg Weight: 3 g copper-plated (Ni-Cu) Magnetisation: N40 strength: approx. 2.2 kg</p>	<p>Price in CHF</p> <p>5 pcs. 0.87 ea. from 15 pcs. 0.76 ea. from 40 pcs. 0.68 ea. from 80 pcs. 0.63 ea.</p>	<p>Strong block magnets in trendy copper-colour! These magnets shimmer reddish-brown-golden and are the eye-catcher on glass magnetic boards and magnetic boards.</p>
<p><b>Q-10-10-04-N</b> Block magnet 10 x 10 x 4 mm, holds approx. 2.2 kg Weight: 3 g Nickel-plated (Ni-Cu-Ni) Magnetisation: N40 strength: approx. 2.2 kg</p>	<p>Price in CHF</p> <p>5 pcs. 0.83 ea. from 15 pcs. 0.72 ea. from 40 pcs. 0.64 ea. from 80 pcs. 0.59 ea.</p>	<p>These block magnets have the right size for attaching postcards to a glass magnetic board for instance.</p>
<p><b>Q-10-10-05-N</b> Block magnet 10 x 10 x 5 mm, holds approx. 2.8 kg Weight: 3.8 g Nickel-plated (Ni-Cu-Ni) Magnetisation: N42 strength: approx. 2.8 kg</p>	<p>Price in CHF</p> <p>5 pcs. 0.96 ea. from 15 pcs. 0.83 ea. from 40 pcs. 0.74 ea. from 80 pcs. 0.68 ea.</p>	<p>Many great projects can be realised with this block magnet. The nickel-plated neodymium block magnet owes its high adhesive force of up to 2.8 kg to its strong N48 magnetisation.</p>
<p><b>Q-12-07-02-HN</b> Block magnet 12 x 7 x 2 mm, holds approx. 1.3 kg Weight: 1.3 g Nickel-plated (Ni-Cu-Ni) Magnetisation: 44H strength: approx. 1.3 kg</p>	<p>Price in CHF</p> <p>10 pcs. 0.65 ea. from 40 pcs. 0.53 ea. from 80 pcs. 0.49 ea. from 160 pcs. 0.44 ea.</p>	<p>Temperature resistant to 120 degrees Celsius.</p>
<p><b>Q-12-08-02-N</b> Block magnet 12 x 8 x 2 mm, holds approx. 1.5 kg Weight: 1.5 g Nickel-plated (Ni-Cu-Ni) Magnetisation: N50 strength: approx. 1.5 kg</p>	<p>Price in CHF</p> <p>10 pcs. 0.61 ea. from 40 pcs. 0.50 ea. from 80 pcs. 0.46 ea. from 160 pcs. 0.42 ea.</p>	
<p><b>Q-15-04-04-MN</b> Block magnet 15 x 4 x 4 mm, holds approx. 1.7 kg Weight: 1.8 g Nickel-plated (Ni-Cu-Ni) Magnetisation: 45M strength: approx. 1.7 kg</p>	<p>Price in CHF</p> <p>10 pcs. 0.51 ea. from 40 pcs. 0.43 ea. from 80 pcs. 0.39 ea. from 160 pcs. 0.36 ea.</p>	<p>The axis of magnetisation is along the 4 mm axis. Temperature-resistant up to 100 degrees Celsius. The right size for your first attempts with Halbach-Arrays.</p>
<p><b>Q-15-15-03-N</b> Block magnet 15 x 15 x 3 mm, holds approx. 3.4 kg Weight: 5.1 g Nickel-plated (Ni-Cu-Ni) Magnetisation: N45 strength: approx. 3.4 kg</p>	<p>Price in CHF</p> <p>5 pcs. 1.32 ea. from 15 pcs. 1.15 ea. from 40 pcs. 1.03 ea. from 80 pcs. 0.96 ea.</p>	
<p><b>Q-15-15-08-N</b> Block magnet 15 x 15 x 8 mm, holds approx. 7.6 kg Weight: 14 g Nickel-plated (Ni-Cu-Ni) Magnetisation: N42 strength: approx. 7.6 kg</p>	<p>Price in CHF</p> <p>1 pc. 2.95 ea. from 3 pcs. 2.60 ea. from 10 pcs. 2.30 ea. from 20 pcs. 2.15 ea. from 40 pcs. 2.05 ea.</p>	<p>This little block magnet has an adhesive force of more than 7 kg. The neodymium magnet is particularly suitable for making knife racks, for example.</p>
<p><b>Q-18-08-04-Z</b> Block magnet 18 x 8 x 4 mm, holds approx. 2.7 kg Weight: 4.4 g Zinc-plated (Zn) Magnetisation: N45 strength: approx. 2.7 kg</p>	<p>Price in CHF</p> <p>5 pcs. 1.13 ea. from 15 pcs. 0.99 ea. from 40 pcs. 0.88 ea. from 80 pcs. 0.82 ea.</p>	<p>Contrary to our standard articles, these block magnets are made of zinc and not nickel-coated. Zinc gives them a slightly blue and matt appearance.</p>

<p><b>Q-18-15-10-Z</b> Block magnet 18 x 15 x 10 mm, holds approx. 9.8 kg Weight: 21 g Zinc-plated (Zn) Magnetisation: N45 strength: approx. 9.8 kg</p>	<p>Price in CHF</p> <table> <tr><td>1 pc.</td><td>3.45 ea.</td></tr> <tr><td>from 3 pcs.</td><td>3.05 ea.</td></tr> <tr><td>from 10 pcs.</td><td>2.65 ea.</td></tr> <tr><td>from 20 pcs.</td><td>2.45 ea.</td></tr> <tr><td>from 40 pcs.</td><td>2.30 ea.</td></tr> </table>	1 pc.	3.45 ea.	from 3 pcs.	3.05 ea.	from 10 pcs.	2.65 ea.	from 20 pcs.	2.45 ea.	from 40 pcs.	2.30 ea.	<p>Contrary to our standard articles, these block magnets are made of zinc and not nickel-coated. Zinc gives them a slightly blue and matt appearance.</p>
1 pc.	3.45 ea.											
from 3 pcs.	3.05 ea.											
from 10 pcs.	2.65 ea.											
from 20 pcs.	2.45 ea.											
from 40 pcs.	2.30 ea.											
<p><b>Q-18-18-04-Z</b> Block magnet 18 x 18 x 4 mm, holds approx. 4.1 kg Weight: 9.8 g Zinc-plated (Zn) Magnetisation: N45 strength: approx. 4.1 kg</p>	<p>Price in CHF</p> <table> <tr><td>1 pc.</td><td>2.55 ea.</td></tr> <tr><td>from 3 pcs.</td><td>2.25 ea.</td></tr> <tr><td>from 10 pcs.</td><td>1.95 ea.</td></tr> <tr><td>from 20 pcs.</td><td>1.85 ea.</td></tr> <tr><td>from 40 pcs.</td><td>1.70 ea.</td></tr> </table>	1 pc.	2.55 ea.	from 3 pcs.	2.25 ea.	from 10 pcs.	1.95 ea.	from 20 pcs.	1.85 ea.	from 40 pcs.	1.70 ea.	<p>Contrary to our standard articles, these block magnets are made of zinc and not nickel-coated. Zinc gives them a slightly blue and matt appearance.</p>
1 pc.	2.55 ea.											
from 3 pcs.	2.25 ea.											
from 10 pcs.	1.95 ea.											
from 20 pcs.	1.85 ea.											
from 40 pcs.	1.70 ea.											
<p><b>Q-19-13-06-LN</b> Block magnet 19.05 x 12.7 x 6.35 mm, holds approx. 4.1 kg Weight: 12 g Nickel-plated (Ni-Cu-Ni) Magnetisation: N42 (Axis 19.05 mm) strength: approx. 4.1 kg</p>	<p>Price in CHF</p> <table> <tr><td>1 pc.</td><td>2.65 ea.</td></tr> <tr><td>from 3 pcs.</td><td>2.30 ea.</td></tr> <tr><td>from 10 pcs.</td><td>2.00 ea.</td></tr> <tr><td>from 20 pcs.</td><td>1.90 ea.</td></tr> <tr><td>from 40 pcs.</td><td>1.75 ea.</td></tr> </table>	1 pc.	2.65 ea.	from 3 pcs.	2.30 ea.	from 10 pcs.	2.00 ea.	from 20 pcs.	1.90 ea.	from 40 pcs.	1.75 ea.	<p>The same size as the Q-19-13-06-N, but magnetised lengthwise. the two magnet poles are located on the two end faces (6 x 13 mm). The adhesive force of this magnet is somewhat smaller due to the smaller adhesive surface but, because of this, they are much easier to hold and easier to separate.</p>
1 pc.	2.65 ea.											
from 3 pcs.	2.30 ea.											
from 10 pcs.	2.00 ea.											
from 20 pcs.	1.90 ea.											
from 40 pcs.	1.75 ea.											
<p><b>Q-19-13-06-N</b> Block magnet 19.05 x 12.7 x 6.35 mm, holds approx. 6.5 kg Weight: 12 g Nickel-plated (Ni-Cu-Ni) Magnetisation: N42 strength: approx. 6.5 kg</p>	<p>Price in CHF</p> <table> <tr><td>1 pc.</td><td>2.75 ea.</td></tr> <tr><td>from 3 pcs.</td><td>2.45 ea.</td></tr> <tr><td>from 10 pcs.</td><td>2.15 ea.</td></tr> <tr><td>from 20 pcs.</td><td>2.00 ea.</td></tr> <tr><td>from 40 pcs.</td><td>1.85 ea.</td></tr> </table>	1 pc.	2.75 ea.	from 3 pcs.	2.45 ea.	from 10 pcs.	2.15 ea.	from 20 pcs.	2.00 ea.	from 40 pcs.	1.85 ea.	<p>For its size, this magnet offers an adhesive force of approx. 6.5 kg. It can hold up to 40 sheets of A4 paper (80g/m<sup>2</sup>) on a metal surface. So be careful and watch your fingers!</p>
1 pc.	2.75 ea.											
from 3 pcs.	2.45 ea.											
from 10 pcs.	2.15 ea.											
from 20 pcs.	2.00 ea.											
from 40 pcs.	1.85 ea.											
<p><b>Q-20-04-02-N</b> Block magnet 20 x 4 x 2 mm, holds approx. 1.2 kg Weight: 1.2 g Nickel-plated (Ni-Cu-Ni) Magnetisation: N45 strength: approx. 1.2 kg</p>	<p>Price in CHF</p> <table> <tr><td>10 pcs.</td><td>0.48 ea.</td></tr> <tr><td>from 40 pcs.</td><td>0.40 ea.</td></tr> <tr><td>from 80 pcs.</td><td>0.37 ea.</td></tr> <tr><td>from 160 pcs.</td><td>0.34 ea.</td></tr> </table>	10 pcs.	0.48 ea.	from 40 pcs.	0.40 ea.	from 80 pcs.	0.37 ea.	from 160 pcs.	0.34 ea.	<p>Extra strong (N45) magnets. These magnets are often used by model airplane builders. Heat resistant up to 80 degrees Celsius.</p>		
10 pcs.	0.48 ea.											
from 40 pcs.	0.40 ea.											
from 80 pcs.	0.37 ea.											
from 160 pcs.	0.34 ea.											
<p><b>Q-20-04-03-N</b> Block magnet 20 x 4 x 3 mm, holds approx. 2.4 kg Weight: 1.8 g Nickel-plated (Ni-Cu-Ni) Magnetisation: N48 strength: approx. 2.4 kg</p>	<p>Price in CHF</p> <table> <tr><td>5 pcs.</td><td>0.69 ea.</td></tr> <tr><td>from 15 pcs.</td><td>0.60 ea.</td></tr> <tr><td>from 40 pcs.</td><td>0.53 ea.</td></tr> <tr><td>from 80 pcs.</td><td>0.49 ea.</td></tr> </table>	5 pcs.	0.69 ea.	from 15 pcs.	0.60 ea.	from 40 pcs.	0.53 ea.	from 80 pcs.	0.49 ea.			
5 pcs.	0.69 ea.											
from 15 pcs.	0.60 ea.											
from 40 pcs.	0.53 ea.											
from 80 pcs.	0.49 ea.											
<p><b>Q-20-05-02-HN</b> Block magnet 20 x 5 x 2 mm, holds approx. 1.5 kg Weight: 1.5 g Nickel-plated (Ni-Cu-Ni) Magnetisation: 44H strength: approx. 1.5 kg</p>	<p>Price in CHF</p> <table> <tr><td>5 pcs.</td><td>0.63 ea.</td></tr> <tr><td>from 15 pcs.</td><td>0.54 ea.</td></tr> <tr><td>from 40 pcs.</td><td>0.48 ea.</td></tr> <tr><td>from 80 pcs.</td><td>0.44 ea.</td></tr> </table>	5 pcs.	0.63 ea.	from 15 pcs.	0.54 ea.	from 40 pcs.	0.48 ea.	from 80 pcs.	0.44 ea.	<p>This is an especially thin and very flat block magnet. It can sustain a very high maximum operation temperature of 120°C (magnetisation 44H).</p>		
5 pcs.	0.63 ea.											
from 15 pcs.	0.54 ea.											
from 40 pcs.	0.48 ea.											
from 80 pcs.	0.44 ea.											
<p><b>Q-20-05-05-Z</b> Block magnet 20 x 5 x 5 mm, holds approx. 2.5 kg Weight: 3.8 g Zinc-plated (Zn) Magnetisation: N42 strength: approx. 2.5 kg</p>	<p>Price in CHF</p> <table> <tr><td>5 pcs.</td><td>0.95 ea.</td></tr> <tr><td>from 15 pcs.</td><td>0.84 ea.</td></tr> <tr><td>from 40 pcs.</td><td>0.75 ea.</td></tr> <tr><td>from 80 pcs.</td><td>0.70 ea.</td></tr> </table>	5 pcs.	0.95 ea.	from 15 pcs.	0.84 ea.	from 40 pcs.	0.75 ea.	from 80 pcs.	0.70 ea.	<p>Contrary to our standard articles, these block magnets are made of zinc and not nickel-coated. Zinc gives them a slightly blue and matt appearance.</p>		
5 pcs.	0.95 ea.											
from 15 pcs.	0.84 ea.											
from 40 pcs.	0.75 ea.											
from 80 pcs.	0.70 ea.											
<p><b>Q-20-10-02-N</b> Block magnet 20 x 10 x 2 mm, holds approx. 2.1 kg Weight: 3 g Nickel-plated (Ni-Cu-Ni) Magnetisation: N45 strength: approx. 2.1 kg</p>	<p>Price in CHF</p> <table> <tr><td>5 pcs.</td><td>0.87 ea.</td></tr> <tr><td>from 15 pcs.</td><td>0.77 ea.</td></tr> <tr><td>from 40 pcs.</td><td>0.69 ea.</td></tr> <tr><td>from 80 pcs.</td><td>0.64 ea.</td></tr> </table>	5 pcs.	0.87 ea.	from 15 pcs.	0.77 ea.	from 40 pcs.	0.69 ea.	from 80 pcs.	0.64 ea.	<p>A very flat block magnet with an adhesive force of about 2 kg. Especially suitable for tight spaces.</p>		
5 pcs.	0.87 ea.											
from 15 pcs.	0.77 ea.											
from 40 pcs.	0.69 ea.											
from 80 pcs.	0.64 ea.											

<p><b>Q-20-10-05-N</b> Block magnet 20 x 10 x 5 mm, holds approx. 3.8 kg Weight: 7.6 g Nickel-plated (Ni-Cu-Ni) Magnetisation: N42 strength: approx. 3.8 kg</p>	<p>Price in CHF</p> <table> <tr><td>1 pc.</td><td>2.05 ea.</td></tr> <tr><td>from 3 pcs.</td><td>1.80 ea.</td></tr> <tr><td>from 10 pcs.</td><td>1.55 ea.</td></tr> <tr><td>from 20 pcs.</td><td>1.45 ea.</td></tr> <tr><td>from 40 pcs.</td><td>1.35 ea.</td></tr> </table>	1 pc.	2.05 ea.	from 3 pcs.	1.80 ea.	from 10 pcs.	1.55 ea.	from 20 pcs.	1.45 ea.	from 40 pcs.	1.35 ea.	
1 pc.	2.05 ea.											
from 3 pcs.	1.80 ea.											
from 10 pcs.	1.55 ea.											
from 20 pcs.	1.45 ea.											
from 40 pcs.	1.35 ea.											
<p><b>Q-20-20-03-N</b> Block magnet 20 x 20 x 3 mm, holds approx. 4.2 kg Weight: 9.1 g Nickel-plated (Ni-Cu-Ni) Magnetisation: N45 strength: approx. 4.2 kg</p>	<p>Price in CHF</p> <table> <tr><td>1 pc.</td><td>2.30 ea.</td></tr> <tr><td>from 3 pcs.</td><td>2.00 ea.</td></tr> <tr><td>from 10 pcs.</td><td>1.75 ea.</td></tr> <tr><td>from 20 pcs.</td><td>1.65 ea.</td></tr> <tr><td>from 40 pcs.</td><td>1.50 ea.</td></tr> </table>	1 pc.	2.30 ea.	from 3 pcs.	2.00 ea.	from 10 pcs.	1.75 ea.	from 20 pcs.	1.65 ea.	from 40 pcs.	1.50 ea.	<p>Flat, thin magnet. Suitable for permanent installation, for example, with glue. Can also be used to attach two metal objects, for example, metal signs to metal doors or cars, etc. Super strong!</p>
1 pc.	2.30 ea.											
from 3 pcs.	2.00 ea.											
from 10 pcs.	1.75 ea.											
from 20 pcs.	1.65 ea.											
from 40 pcs.	1.50 ea.											
<p><b>Q-20-20-05-N</b> Block magnet 20 x 20 x 5 mm, holds approx. 6 kg Weight: 15 g Nickel-plated (Ni-Cu-Ni) Magnetisation: N42 strength: approx. 6 kg</p>	<p>Price in CHF</p> <table> <tr><td>1 pc.</td><td>3.45 ea.</td></tr> <tr><td>from 3 pcs.</td><td>3.05 ea.</td></tr> <tr><td>from 10 pcs.</td><td>2.70 ea.</td></tr> <tr><td>from 20 pcs.</td><td>2.50 ea.</td></tr> <tr><td>from 40 pcs.</td><td>2.35 ea.</td></tr> </table>	1 pc.	3.45 ea.	from 3 pcs.	3.05 ea.	from 10 pcs.	2.70 ea.	from 20 pcs.	2.50 ea.	from 40 pcs.	2.35 ea.	<p>A very flat, square block magnet. Very popular in the areas of metal, machine and plant construction as well as interior fittings.</p>
1 pc.	3.45 ea.											
from 3 pcs.	3.05 ea.											
from 10 pcs.	2.70 ea.											
from 20 pcs.	2.50 ea.											
from 40 pcs.	2.35 ea.											
<p><b>Q-20-20-10-N</b> Block magnet 20 x 20 x 10 mm, holds approx. 12 kg Weight: 30 g Nickel-plated (Ni-Cu-Ni) Magnetisation: N42 strength: approx. 12 kg</p>	<p>Price in CHF</p> <table> <tr><td>1 pc.</td><td>4.85 ea.</td></tr> <tr><td>from 3 pcs.</td><td>4.30 ea.</td></tr> <tr><td>from 10 pcs.</td><td>3.85 ea.</td></tr> <tr><td>from 20 pcs.</td><td>3.60 ea.</td></tr> <tr><td>from 40 pcs.</td><td>3.40 ea.</td></tr> </table>	1 pc.	4.85 ea.	from 3 pcs.	4.30 ea.	from 10 pcs.	3.85 ea.	from 20 pcs.	3.60 ea.	from 40 pcs.	3.40 ea.	<p>A magnet for the serious magnetist. Only someone with very strong hands can separate two of these magnets from each other. Our customers lovingly called this one "THE SKIN PINCHER". Not for children or magnet weaklings!</p>
1 pc.	4.85 ea.											
from 3 pcs.	4.30 ea.											
from 10 pcs.	3.85 ea.											
from 20 pcs.	3.60 ea.											
from 40 pcs.	3.40 ea.											
<p><b>Q-22-8.5-1.4-SHN</b> Block magnet 22 x 8.5 x 1.4 mm, holds approx. 1.3 kg Weight: 2 g Nickel-plated (Ni-Cu-Ni) Magnetisation: 35SH strength: approx. 1.3 kg</p>	<p>Price in CHF</p> <table> <tr><td>5 pcs.</td><td>0.89 ea.</td></tr> <tr><td>from 15 pcs.</td><td>0.78 ea.</td></tr> <tr><td>from 40 pcs.</td><td>0.69 ea.</td></tr> <tr><td>from 80 pcs.</td><td>0.64 ea.</td></tr> </table>	5 pcs.	0.89 ea.	from 15 pcs.	0.78 ea.	from 40 pcs.	0.69 ea.	from 80 pcs.	0.64 ea.	<p>This is an especially flat and thin block magnet. It is well suited for brushless motors and is therefore popular with model builders. It can sustain a very high maximum operation temperature of 150°C.</p>		
5 pcs.	0.89 ea.											
from 15 pcs.	0.78 ea.											
from 40 pcs.	0.69 ea.											
from 80 pcs.	0.64 ea.											
<p><b>Q-25-06-02-SN</b> Block magnet 25 x 6 x 2 mm, holds approx. 1.7 kg Weight: 2.3 g Nickel-plated (Ni-Cu-Ni) Magnetisation: 45SH strength: approx. 1.7 kg</p>	<p>Price in CHF</p> <table> <tr><td>5 pcs.</td><td>1.06 ea.</td></tr> <tr><td>from 15 pcs.</td><td>0.92 ea.</td></tr> <tr><td>from 40 pcs.</td><td>0.82 ea.</td></tr> <tr><td>from 80 pcs.</td><td>0.76 ea.</td></tr> </table>	5 pcs.	1.06 ea.	from 15 pcs.	0.92 ea.	from 40 pcs.	0.82 ea.	from 80 pcs.	0.76 ea.	<p>This is an especially flat and thin block magnet. It is well suited for brushless motors and is therefore popular with model builders. It can sustain a very high maximum operation temperature of 150°C.</p>		
5 pcs.	1.06 ea.											
from 15 pcs.	0.92 ea.											
from 40 pcs.	0.82 ea.											
from 80 pcs.	0.76 ea.											
<p><b>Q-25-08-01-N</b> Block magnet 25 x 8 x 1 mm, holds approx. 1.1 kg Weight: 1.5 g Nickel-plated (Ni-Cu-Ni) Magnetisation: N48 strength: approx. 1.1 kg</p>	<p>Price in CHF</p> <table> <tr><td>5 pcs.</td><td>0.71 ea.</td></tr> <tr><td>from 15 pcs.</td><td>0.61 ea.</td></tr> <tr><td>from 40 pcs.</td><td>0.54 ea.</td></tr> <tr><td>from 80 pcs.</td><td>0.50 ea.</td></tr> </table>	5 pcs.	0.71 ea.	from 15 pcs.	0.61 ea.	from 40 pcs.	0.54 ea.	from 80 pcs.	0.50 ea.			
5 pcs.	0.71 ea.											
from 15 pcs.	0.61 ea.											
from 40 pcs.	0.54 ea.											
from 80 pcs.	0.50 ea.											
<p><b>Q-25-15-06-N</b> Block magnet 25 x 15 x 6 mm, holds approx. 7 kg Weight: 17 g Nickel-plated (Ni-Cu-Ni) Magnetisation: N45 strength: approx. 7 kg</p>	<p>Price in CHF</p> <table> <tr><td>1 pc.</td><td>3.25 ea.</td></tr> <tr><td>from 3 pcs.</td><td>2.85 ea.</td></tr> <tr><td>from 10 pcs.</td><td>2.50 ea.</td></tr> <tr><td>from 20 pcs.</td><td>2.30 ea.</td></tr> <tr><td>from 40 pcs.</td><td>2.15 ea.</td></tr> </table>	1 pc.	3.25 ea.	from 3 pcs.	2.85 ea.	from 10 pcs.	2.50 ea.	from 20 pcs.	2.30 ea.	from 40 pcs.	2.15 ea.	
1 pc.	3.25 ea.											
from 3 pcs.	2.85 ea.											
from 10 pcs.	2.50 ea.											
from 20 pcs.	2.30 ea.											
from 40 pcs.	2.15 ea.											
<p><b>Q-25-25-13-N</b> Block magnet 25.4 x 25.4 x 12.7 mm, holds approx. 20 kg Weight: 62 g Nickel-plated (Ni-Cu-Ni) Magnetisation: N40 strength: approx. 20 kg</p>	<p>Price in CHF</p> <table> <tr><td>1 pc.</td><td>9.30 ea.</td></tr> <tr><td>from 3 pcs.</td><td>8.30 ea.</td></tr> <tr><td>from 10 pcs.</td><td>7.40 ea.</td></tr> <tr><td>from 20 pcs.</td><td>6.95 ea.</td></tr> <tr><td>from 40 pcs.</td><td>6.60 ea.</td></tr> </table>	1 pc.	9.30 ea.	from 3 pcs.	8.30 ea.	from 10 pcs.	7.40 ea.	from 20 pcs.	6.95 ea.	from 40 pcs.	6.60 ea.	<p>We simply call this one THE GIANT. Very, very powerful. If two of these become stuck together, you'll have a hard time separating them with only your bare hands, and then only with a great deal of effort. Not suitable for children!</p>
1 pc.	9.30 ea.											
from 3 pcs.	8.30 ea.											
from 10 pcs.	7.40 ea.											
from 20 pcs.	6.95 ea.											
from 40 pcs.	6.60 ea.											

<p><b>Q-30-07-2.5-HE</b> Block magnet 30 x 7 x 2.5 mm, holds approx. 2.1 kg Weight: 4 g Epoxy coating (Ni-Cu-Ni-Epoxy) Magnetisation: 38H strength: approx. 2.1 kg</p>	<p>Price in CHF</p> <p>5 pcs. 1.12 ea. from 15 pcs. 0.98 ea. from 40 pcs. 0.87 ea. from 80 pcs. 0.80 ea.</p>	<p>A flat industrial magnet with a Ni-Cu-Ni base coat and a black epoxy resin cover coating. It can be glued together well with epoxy resin.</p>
<p><b>Q-30-10-05-N</b> Block magnet 30 x 10 x 5 mm, holds approx. 6.5 kg Weight: 11 g Nickel-plated (Ni-Cu-Ni) Magnetisation: N42 strength: approx. 6.5 kg</p>	<p>Price in CHF</p> <p>1 pc. 2.25 ea. from 3 pcs. 2.00 ea. from 10 pcs. 1.75 ea. from 20 pcs. 1.60 ea. from 40 pcs. 1.50 ea.</p>	
<p><b>Q-30-10-10-Z</b> Block magnet 30 x 10 x 10 mm, holds approx. 8.8 kg Weight: 23 g Zinc-plated (Zn) Magnetisation: N40 strength: approx. 8.8 kg</p>	<p>Price in CHF</p> <p>1 pc. 4.15 ea. from 3 pcs. 3.70 ea. from 10 pcs. 3.30 ea. from 20 pcs. 3.10 ea. from 40 pcs. 2.90 ea.</p>	<p>Contrary to our standard articles, these block magnets are made of zinc and not nickel-coated. Zinc gives them a slightly blue and matt appearance.</p>
<p><b>Q-30-12-12-Z</b> Block magnet 30 x 12 x 12 mm, holds approx. 9.4 kg Weight: 33 g Zinc-plated (Zn) Magnetisation: N52 strength: approx. 9.4 kg</p>	<p>Price in CHF</p> <p>1 pc. 6.70 ea. from 3 pcs. 6.00 ea. from 10 pcs. 5.40 ea. from 20 pcs. 5.10 ea. from 40 pcs. 4.80 ea.</p>	<p>Contrary to our standard articles, these block magnets are made of zinc and not nickel-coated. Zinc gives them a slightly blue and matt appearance.</p>
<p><b>Q-30-15-06-Z</b> Block magnet 30 x 15 x 6 mm, holds approx. 8.8 kg Weight: 21 g Zinc-plated (Zn) Magnetisation: 42SH strength: approx. 8.8 kg</p>	<p>Price in CHF</p> <p>1 pc. 5.50 ea. from 3 pcs. 4.95 ea. from 10 pcs. 4.40 ea. from 20 pcs. 4.15 ea. from 40 pcs. 3.95 ea.</p>	<p>Contrary to our standard articles, these block magnets are made of zinc and not nickel-coated. Zinc gives them a slightly blue and matt appearance.</p>
<p><b>Q-30-30-15-N</b> Block magnet 30 x 30 x 15 mm, holds approx. 35 kg Weight: 100 g Nickel-plated (Ni-Cu-Ni) Magnetisation: N45 strength: approx. 35 kg</p>	<p>Price in CHF</p> <p>1 pc. 16.30 ea. from 3 pcs. 14.80 ea. from 10 pcs. 13.45 ea. from 20 pcs. 12.80 ea. from 40 pcs. 12.20 ea.</p>	
<p><b>Q-40-10-05-N</b> Block magnet 40 x 10 x 5 mm, holds approx. 9.5 kg Weight: 15 g Nickel-plated (Ni-Cu-Ni) Magnetisation: N42 strength: approx. 9.5 kg</p>	<p>Price in CHF</p> <p>1 pc. 3.30 ea. from 3 pcs. 2.95 ea. from 10 pcs. 2.60 ea. from 20 pcs. 2.40 ea. from 40 pcs. 2.25 ea.</p>	<p>A slim, but very strong block magnet. Very popular in the areas of interior fittings, machine construction and cabinetmaking.</p>
<p><b>Q-40-10-10-N</b> Block magnet 40 x 10 x 10 mm, holds approx. 15 kg Weight: 30 g Nickel-plated (Ni-Cu-Ni) Magnetisation: N42 strength: approx. 15 kg</p>	<p>Price in CHF</p> <p>1 pc. 5.30 ea. from 3 pcs. 4.70 ea. from 10 pcs. 4.15 ea. from 20 pcs. 3.85 ea. from 40 pcs. 3.65 ea.</p>	<p>A very slim block magnet with an adhesive force of impressive 15 kg. Our customers build it into lamps or wood/metal furniture.</p>
<p><b>Q-40-15-05-N</b> Block magnet 40 x 15 x 5 mm, holds approx. 8 kg Weight: 23 g Nickel-plated (Ni-Cu-Ni) Magnetisation: N40 strength: approx. 8 kg</p>	<p>Price in CHF</p> <p>1 pc. 4.40 ea. from 3 pcs. 3.85 ea. from 10 pcs. 3.40 ea. from 20 pcs. 3.15 ea. from 40 pcs. 2.95 ea.</p>	

<p><b>Q-40-18-05-N</b> Block magnet 40 x 18 x 5 mm, holds approx. 8 kg Weight: 27 g Nickel-plated (Ni-Cu-Ni) Magnetisation: N35 strength: approx. 8 kg</p>	<p>Price in CHF</p> <table> <tr><td>1 pc.</td><td>4.95 ea.</td></tr> <tr><td>from 3 pcs.</td><td>4.40 ea.</td></tr> <tr><td>from 10 pcs.</td><td>3.90 ea.</td></tr> <tr><td>from 20 pcs.</td><td>3.65 ea.</td></tr> <tr><td>from 40 pcs.</td><td>3.45 ea.</td></tr> </table>	1 pc.	4.95 ea.	from 3 pcs.	4.40 ea.	from 10 pcs.	3.90 ea.	from 20 pcs.	3.65 ea.	from 40 pcs.	3.45 ea.	
1 pc.	4.95 ea.											
from 3 pcs.	4.40 ea.											
from 10 pcs.	3.90 ea.											
from 20 pcs.	3.65 ea.											
from 40 pcs.	3.45 ea.											
<p><b>Q-40-20-05-N</b> Block magnet 40 x 20 x 5 mm, holds approx. 14 kg Weight: 30 g Nickel-plated (Ni-Cu-Ni) Magnetisation: N42 strength: approx. 14 kg</p>	<p>Price in CHF</p> <table> <tr><td>1 pc.</td><td>5.20 ea.</td></tr> <tr><td>from 3 pcs.</td><td>4.65 ea.</td></tr> <tr><td>from 10 pcs.</td><td>4.20 ea.</td></tr> <tr><td>from 20 pcs.</td><td>3.95 ea.</td></tr> <tr><td>from 40 pcs.</td><td>3.75 ea.</td></tr> </table>	1 pc.	5.20 ea.	from 3 pcs.	4.65 ea.	from 10 pcs.	4.20 ea.	from 20 pcs.	3.95 ea.	from 40 pcs.	3.75 ea.	
1 pc.	5.20 ea.											
from 3 pcs.	4.65 ea.											
from 10 pcs.	4.20 ea.											
from 20 pcs.	3.95 ea.											
from 40 pcs.	3.75 ea.											
<p><b>Q-40-20-10-N</b> Block magnet 40 x 20 x 10 mm, holds approx. 25 kg Weight: 61 g Nickel-plated (Ni-Cu-Ni) Magnetisation: N42 strength: approx. 25 kg</p>	<p>Price in CHF</p> <table> <tr><td>1 pc.</td><td>9.85 ea.</td></tr> <tr><td>from 3 pcs.</td><td>8.75 ea.</td></tr> <tr><td>from 10 pcs.</td><td>7.75 ea.</td></tr> <tr><td>from 20 pcs.</td><td>7.30 ea.</td></tr> <tr><td>from 40 pcs.</td><td>6.85 ea.</td></tr> </table>	1 pc.	9.85 ea.	from 3 pcs.	8.75 ea.	from 10 pcs.	7.75 ea.	from 20 pcs.	7.30 ea.	from 40 pcs.	6.85 ea.	<p>Neodymium block magnet with an adhesive force of 25 kg. Very popular with our customers in machine building and plant construction.</p>
1 pc.	9.85 ea.											
from 3 pcs.	8.75 ea.											
from 10 pcs.	7.75 ea.											
from 20 pcs.	7.30 ea.											
from 40 pcs.	6.85 ea.											
<p><b>Q-40-40-20-N</b> Block magnet 40 x 40 x 20 mm, holds approx. 60 kg Weight: 240 g Nickel-plated (Ni-Cu-Ni) Magnetisation: N42 strength: approx. 60 kg</p>	<p>Price in CHF</p> <table> <tr><td>1 pc.</td><td>32.20 ea.</td></tr> <tr><td>from 3 pcs.</td><td>28.80 ea.</td></tr> <tr><td>from 10 pcs.</td><td>25.80 ea.</td></tr> <tr><td>from 20 pcs.</td><td>24.35 ea.</td></tr> <tr><td>from 40 pcs.</td><td>23.05 ea.</td></tr> </table>	1 pc.	32.20 ea.	from 3 pcs.	28.80 ea.	from 10 pcs.	25.80 ea.	from 20 pcs.	24.35 ea.	from 40 pcs.	23.05 ea.	<p>You'd like to do more than just conveniently hang your sledgehammer, but you're not quite ready for the DEATH MAGNET? Then perhaps this is the right magnet for you: THE COLOSSUS!</p>
1 pc.	32.20 ea.											
from 3 pcs.	28.80 ea.											
from 10 pcs.	25.80 ea.											
from 20 pcs.	24.35 ea.											
from 40 pcs.	23.05 ea.											
<p><b>Q-46-30-10-N</b> Block magnet 46 x 30 x 10 mm, holds approx. 29 kg Weight: 100 g Nickel-plated (Ni-Cu-Ni) Magnetisation: N40 strength: approx. 29 kg</p>	<p>Price in CHF</p> <table> <tr><td>1 pc.</td><td>12.45 ea.</td></tr> <tr><td>from 3 pcs.</td><td>11.10 ea.</td></tr> <tr><td>from 10 pcs.</td><td>9.90 ea.</td></tr> <tr><td>from 20 pcs.</td><td>9.35 ea.</td></tr> <tr><td>from 40 pcs.</td><td>8.80 ea.</td></tr> </table>	1 pc.	12.45 ea.	from 3 pcs.	11.10 ea.	from 10 pcs.	9.90 ea.	from 20 pcs.	9.35 ea.	from 40 pcs.	8.80 ea.	
1 pc.	12.45 ea.											
from 3 pcs.	11.10 ea.											
from 10 pcs.	9.90 ea.											
from 20 pcs.	9.35 ea.											
from 40 pcs.	8.80 ea.											
<p><b>Q-50-15-15-N</b> Block magnet 50 x 15 x 15 mm, holds approx. 33 kg Weight: 86 g Nickel-plated (Ni-Cu-Ni) Magnetisation: N48 strength: approx. 33 kg</p>	<p>Price in CHF</p> <table> <tr><td>1 pc.</td><td>14.50 ea.</td></tr> <tr><td>from 3 pcs.</td><td>13.15 ea.</td></tr> <tr><td>from 10 pcs.</td><td>11.95 ea.</td></tr> <tr><td>from 20 pcs.</td><td>11.40 ea.</td></tr> <tr><td>from 40 pcs.</td><td>10.85 ea.</td></tr> </table>	1 pc.	14.50 ea.	from 3 pcs.	13.15 ea.	from 10 pcs.	11.95 ea.	from 20 pcs.	11.40 ea.	from 40 pcs.	10.85 ea.	
1 pc.	14.50 ea.											
from 3 pcs.	13.15 ea.											
from 10 pcs.	11.95 ea.											
from 20 pcs.	11.40 ea.											
from 40 pcs.	10.85 ea.											
<p><b>Q-50-25-10-LN</b> Block magnet 50 x 25 x 10 mm, holds approx. 12 kg Weight: 95 g Nickel-plated (Ni-Cu-Ni) Magnetisation: N40 (Axis 50 mm) strength: approx. 12 kg</p>	<p>Price in CHF</p> <table> <tr><td>1 pc.</td><td>14.80 ea.</td></tr> <tr><td>from 3 pcs.</td><td>13.15 ea.</td></tr> <tr><td>from 10 pcs.</td><td>11.70 ea.</td></tr> <tr><td>from 20 pcs.</td><td>10.95 ea.</td></tr> <tr><td>from 40 pcs.</td><td>10.35 ea.</td></tr> </table>	1 pc.	14.80 ea.	from 3 pcs.	13.15 ea.	from 10 pcs.	11.70 ea.	from 20 pcs.	10.95 ea.	from 40 pcs.	10.35 ea.	<p>This magnet is magnetised lengthwise, meaning north and south pole are located on both of the smallest surfaces.</p>
1 pc.	14.80 ea.											
from 3 pcs.	13.15 ea.											
from 10 pcs.	11.70 ea.											
from 20 pcs.	10.95 ea.											
from 40 pcs.	10.35 ea.											
<p><b>Q-50-50-12.5-N</b> Block magnet 50 x 50 x 12.5 mm, holds approx. 47 kg Weight: 240 g Nickel-plated (Ni-Cu-Ni) Magnetisation: N35 strength: approx. 47 kg</p>	<p>Price in CHF</p> <table> <tr><td>1 pc.</td><td>29.60 ea.</td></tr> <tr><td>from 3 pcs.</td><td>26.55 ea.</td></tr> <tr><td>from 10 pcs.</td><td>23.75 ea.</td></tr> <tr><td>from 20 pcs.</td><td>22.40 ea.</td></tr> <tr><td>from 40 pcs.</td><td>21.25 ea.</td></tr> </table>	1 pc.	29.60 ea.	from 3 pcs.	26.55 ea.	from 10 pcs.	23.75 ea.	from 20 pcs.	22.40 ea.	from 40 pcs.	21.25 ea.	<p>A flat block magnet with 50 x 50 x 12.5 mm dimensions.</p>
1 pc.	29.60 ea.											
from 3 pcs.	26.55 ea.											
from 10 pcs.	23.75 ea.											
from 20 pcs.	22.40 ea.											
from 40 pcs.	21.25 ea.											
<p><b>Q-51-51-25-N</b> Block magnet 50.8 x 50.8 x 25.4 mm, holds approx. 100 kg Weight: 500 g Nickel-plated (Ni-Cu-Ni) Magnetisation: N40 strength: approx. 100 kg</p>	<p>Price in CHF</p> <table> <tr><td>1 pc.</td><td>54.90 ea.</td></tr> <tr><td>from 3 pcs.</td><td>49.70 ea.</td></tr> <tr><td>from 10 pcs.</td><td>45.05 ea.</td></tr> <tr><td>from 20 pcs.</td><td>42.80 ea.</td></tr> <tr><td>from 40 pcs.</td><td>40.80 ea.</td></tr> </table>	1 pc.	54.90 ea.	from 3 pcs.	49.70 ea.	from 10 pcs.	45.05 ea.	from 20 pcs.	42.80 ea.	from 40 pcs.	40.80 ea.	<p>We call this magnet THE DEATH MAGNET. I have no idea what you can reasonably do with this magnet - it is simply too intense for most applications. BE CAREFUL!!!</p>
1 pc.	54.90 ea.											
from 3 pcs.	49.70 ea.											
from 10 pcs.	45.05 ea.											
from 20 pcs.	42.80 ea.											
from 40 pcs.	40.80 ea.											

<p><b>Q-60-30-15-N</b> Block magnet 60 x 30 x 15 mm, holds approx. 56 kg Weight: 210 g Nickel-plated (Ni-Cu-Ni) Magnetisation: N40 strength: approx. 56 kg</p>	<p>Price in CHF 1 pc. 24.70 ea. from 3 pcs. 22.15 ea. from 10 pcs. 19.80 ea. from 20 pcs. 18.70 ea. from 40 pcs. 17.70 ea.</p>	<p>With an adhesive force of over 50 kg, this block magnet is one of our strongest magnets. Its adhesive force bridges several centimetres of distance, e.g. through a thick book.</p>
<p><b>Q-70-70-30-N</b> Block magnet 70 x 70 x 30 mm, holds approx. 150 kg Weight: 1.1 kg Nickel-plated (Ni-Cu-Ni) Magnetisation: N40 strength: approx. 150 kg</p>	<p>Price in CHF 1 pc. 111.35 ea. from 3 pcs. 102.40 ea. from 10 pcs. 94.40 ea. from 20 pcs. 90.50 ea. from 40 pcs. 87.05 ea.</p>	<p>After the MONOLITH, the GOLIATH is the second strongest magnet in our assortment. Due to its high adhesive force, the GOLIATH is a very dangerous magnet and not suitable for magnet novices. Please follow the enclosed safety tips.</p>
<p><b>Q-111-89-20-E</b> Block magnet 110.6 x 89 x 19.5 mm, holds approx. 200 kg Weight: 1.5 kg Epoxy coating (Ni-Cu-Ni-Epoxy) Magnetisation: N45 strength: approx. 200 kg</p>	<p>Price in CHF 1 pc. 149.20 ea. from 3 pcs. 140.50 ea. from 10 pcs. 132.70 ea. from 20 pcs. 128.90 ea. from 40 pcs. 125.55 ea.</p>	<p>The MONOLITH is the strongest magnet we ever carried in our supermagnete assortment. Due to its high adhesive force, the MONOLITH is a very dangerous magnet and not suitable for magnet novices. It is imperative that you carefully review the enclosed safety tips.</p>



## Cube magnets neodymium

All cube magnets have their north and south pole on two opposing surfaces.

<p><b>W-01-N</b> Cube magnet 1 mm, holds approx. 37 g Weight: 0.0076 g Nickel-plated (Ni-Cu-Ni) Magnetisation: N45 strength: approx. 37 g</p>	<p>Price in CHF 20 pcs. 0.18 ea. from 60 pcs. 0.15 ea. from 140 pcs. 0.13 ea. from 360 pcs. 0.11 ea.</p>	<p>They don't come much smaller than this! It's hard to believe, but this mini-magnet has the strength to pin a little note to the wall.</p>
<p><b>W-03-N</b> Cube magnet 3 mm, holds approx. 290 g Weight: 0.21 g Nickel-plated (Ni-Cu-Ni) Magnetisation: N45 strength: approx. 290 g</p>	<p>Price in CHF 20 pcs. 0.22 ea. from 60 pcs. 0.18 ea. from 140 pcs. 0.16 ea. from 360 pcs. 0.14 ea.</p>	
<p><b>W-04-N</b> Cube magnet 4 mm, holds approx. 500 g Weight: 0.49 g Nickel-plated (Ni-Cu-Ni) Magnetisation: N42 strength: approx. 500 g</p>	<p>Price in CHF 10 pcs. 0.30 ea. from 40 pcs. 0.24 ea. from 80 pcs. 0.21 ea. from 160 pcs. 0.19 ea.</p>	
<p><b>W-05-G</b> Cube magnet 5 mm, holds approx. 1.1 kg Weight: 0.95 g Gold-plated (Ni-Cu-Ni-Au) Magnetisation: N42 strength: approx. 1.1 kg</p>	<p>Price in CHF 10 pcs. 0.43 ea. from 40 pcs. 0.35 ea. from 80 pcs. 0.32 ea. from 160 pcs. 0.29 ea.</p>	<p>Same cube as the W-05-N, but plated with real gold. Looks even finer.</p>
<p><b>W-05-N</b> Cube magnet 5 mm, holds approx. 1.1 kg Weight: 0.95 g Nickel-plated (Ni-Cu-Ni) Magnetisation: N42 strength: approx. 1.1 kg</p>	<p>Price in CHF 10 pcs. 0.39 ea. from 40 pcs. 0.32 ea. from 80 pcs. 0.30 ea. from 160 pcs. 0.27 ea.</p>	<p>A small cube magnet with 5 mm edge length. Its adhesive force of 1 kg is astounding for such a small magnet. A perfect and extremely discreet fridge or whiteboard magnet - one of our top sellers for good reason.</p>
<p><b>W-05-N50-G</b> Cube magnet 5 mm, holds approx. 1.2 kg Weight: 0.95 g Gold-plated (Ni-Cu-Ni-Au) Magnetisation: N50 strength: approx. 1.2 kg</p>	<p>Price in CHF 10 pcs. 0.42 ea. from 40 pcs. 0.35 ea. from 80 pcs. 0.32 ea. from 160 pcs. 0.29 ea.</p>	<p>Same article as W-05-G, but with the strongest possible magnetisation. Primarily interesting for model engine enthusiasts. For everyday jobs (hanging-up notes and photos, etc.), you'd do better with the cheaper W-05-G.</p>
<p><b>W-05-N50-N</b> Cube magnet 5 mm, holds approx. 1.2 kg Weight: 0.95 g Nickel-plated (Ni-Cu-Ni) Magnetisation: N50 strength: approx. 1.2 kg</p>	<p>Price in CHF 10 pcs. 0.41 ea. from 40 pcs. 0.34 ea. from 80 pcs. 0.31 ea. from 160 pcs. 0.28 ea.</p>	<p>Identical article to W-05-N, but with the highest magnetisation (N50). Most interesting for builders of model motors. For day to day use (to hang up notes and photos), the cheaper W-05-N is a better fit.</p>
<p><b>W-06-N</b> Cube magnet 6 mm, holds approx. 1.3 kg Weight: 1.6 g Nickel-plated (Ni-Cu-Ni) Magnetisation: N42 strength: approx. 1.3 kg</p>	<p>Price in CHF 5 pcs. 0.49 ea. from 15 pcs. 0.42 ea. from 40 pcs. 0.37 ea. from 80 pcs. 0.34 ea.</p>	<p>These cube magnets can hold small notes on a magnetic glass board, on a whiteboard several layers of paper.</p>

<p><b>W-07-K</b> Cube magnet 7 mm, holds approx. 1.6 kg Weight: 2.6 g copper-plated (Ni-Cu) Magnetisation: N42 strength: approx. 1.6 kg Colour: Copper</p>	<p>Price in CHF 5 pcs. 0.76 ea. from 15 pcs. 0.65 ea. from 40 pcs. 0.58 ea. from 80 pcs. 0.53 ea.</p>	<p>Strong cube magnets in trendy copper-colour! These magnets shimmer reddish-brown-golden and are the eye-catcher on glass magnetic boards and magnetic boards.</p>
<p><b>W-07-N</b> Cube magnet 7 mm, holds approx. 1.6 kg Weight: 2.6 g Nickel-plated (Ni-Cu-Ni) Magnetisation: N42 strength: approx. 1.6 kg</p>	<p>Price in CHF 5 pcs. 0.78 ea. from 15 pcs. 0.68 ea. from 40 pcs. 0.61 ea. from 80 pcs. 0.56 ea.</p>	<p>Super magnets that can hold it together. They have a proven track record as newspaper holder and bicycle clamp.</p>
<p><b>W-10-N</b> Cube magnet 10 mm, holds approx. 3.8 kg Weight: 7.6 g Nickel-plated (Ni-Cu-Ni) Magnetisation: N42 strength: approx. 3.8 kg Colour: Silver-coloured</p>	<p>Price in CHF 1 pc. 1.90 ea. from 3 pcs. 1.65 ea. from 10 pcs. 1.45 ea. from 20 pcs. 1.35 ea. from 40 pcs. 1.25 ea.</p>	<p>Cube-shaped magnets are somewhat unusual. These are strong enough to attract each other through the thickness of a hand. It takes a bit of determination to separate two of these magnets from each other.</p>
<p><b>W-12-N</b> Cube magnet 12 mm, holds approx. 6.3 kg Weight: 13 g Nickel-plated (Ni-Cu-Ni) Magnetisation: N48 strength: approx. 6.3 kg Colour: Silver-coloured</p>	<p>Price in CHF 1 pc. 3.20 ea. from 3 pcs. 2.85 ea. from 10 pcs. 2.50 ea. from 20 pcs. 2.35 ea. from 40 pcs. 2.20 ea.</p>	<p>A fat, strong cube magnet with an adhesive force of 6 kg. Two of these cubes can only be separated with a lot of effort.</p>

## Magnetic spheres made of neodymium

Please note: Due to the danger of swallowing, magnetic spheres are not suitable as toys for children and should be kept out of reach of small children. If they swallow several small magnets, they can accumulate in the intestines and cause life-threatening injuries.

<p><b>K-03-C</b> Sphere magnet Ø 3 mm, holds approx. 130 g Weight: 0.11 g Chrome-plated (Ni-Cu-Ni-Cr) Magnetisation: N42 strength: approx. 130 g</p>	<p>Price in CHF</p> <p>20 pcs. 0.40 ea. from 60 pcs. 0.34 ea. from 140 pcs. 0.31 ea. from 360 pcs. 0.27 ea.</p>	<p>Unleash your creativity! With the small magnetic spheres you can always make new creations with little effort. Please let your friends also experiment with them.</p>
<p><b>K-05-C</b> Sphere magnet Ø 5 mm, holds approx. 360 g Weight: 0.5 g Chrome-plated (Ni-Cu-Ni-Cr) Magnetisation: N42 strength: approx. 360 g</p>	<p>Price in CHF</p> <p>10 pcs. 0.47 ea. from 40 pcs. 0.39 ea. from 80 pcs. 0.35 ea. from 160 pcs. 0.32 ea.</p>	<p>Sphere magnets with 5 mm diameter.</p>
<p><b>K-05-N</b> Sphere magnet Ø 5 mm, holds approx. 300 g Weight: 0.5 g Nickel-plated (Ni-Cu-Ni) Magnetisation: N35 strength: approx. 300 g</p>	<p>Price in CHF</p> <p>20 pcs. 0.21 ea. from 60 pcs. 0.19 ea. from 140 pcs. 0.17 ea. from 360 pcs. 0.16 ea.</p>	<p>Nickel-coated small sphere magnets for endless combining and experimenting. Available in units of 10. ATTENTION: Not suitable for children under 14!</p>
<p><b>K-06-C</b> Sphere magnet Ø 6 mm, holds approx. 470 g Weight: 0.86 g Chrome-plated (Ni-Cu-Ni-Cr) Magnetisation: N38 strength: approx. 470 g</p>	<p>Price in CHF</p> <p>20 pcs. 0.49 ea. from 60 pcs. 0.43 ea. from 140 pcs. 0.39 ea. from 360 pcs. 0.35 ea.</p>	<p>Magnet spheres with a diameter of 6 mm.</p>
<p><b>K-08-C</b> Sphere magnet Ø 8 mm, holds approx. 850 g Weight: 2 g Chrome-plated (Ni-Cu-Ni-Cr) Magnetisation: N38 strength: approx. 850 g</p>	<p>Price in CHF</p> <p>10 pcs. 0.81 ea. from 40 pcs. 0.69 ea. from 80 pcs. 0.64 ea. from 160 pcs. 0.60 ea.</p>	<p>Everyone's Favourite Magnet! This 8 mm magnetic sphere is chrome-plated and perfect for experimenting and combining with other magnets. Once you've held them in your hands, you won't want to put them down.</p>
<p><b>K-10-C</b> Sphere magnet Ø 10 mm, holds approx. 1.4 kg Weight: 4 g Chrome-plated (Ni-Cu-Ni-Cr) Magnetisation: N40 strength: approx. 1.4 kg</p>	<p>Price in CHF</p> <p>10 pcs. 1.11 ea. from 40 pcs. 0.97 ea. from 80 pcs. 0.91 ea. from 160 pcs. 0.86 ea.</p>	<p>Extra fat magnet spheres! 10 mm diameter and, naturally, super strong. For the advanced magnet connoisseur.</p>
<p><b>K-13-C</b> Sphere magnet Ø 12.7 mm, holds approx. 2.4 kg Weight: 8.2 g Chrome-plated (Ni-Cu-Ni-Cr) Magnetisation: N42 strength: approx. 2.4 kg</p>	<p>Price in CHF</p> <p>1 pc. 2.70 ea. from 3 pcs. 2.40 ea. from 10 pcs. 2.10 ea. from 20 pcs. 2.00 ea. from 40 pcs. 1.85 ea.</p>	<p>Ideal to combine with our steel balls, which are exactly the same size.</p>
<p><b>K-19-C</b> Sphere magnet Ø 19 mm, holds approx. 4.9 kg Weight: 27 g Chrome-plated (Ni-Cu-Ni-Cr) Magnetisation: N38 strength: approx. 4.9 kg</p>	<p>Price in CHF</p> <p>5 pcs. 5.27 ea. from 15 pcs. 4.79 ea. from 40 pcs. 4.42 ea. from 80 pcs. 4.20 ea.</p>	<p>Real monster-spheres! I know adults who were not able to separate these magnets from each other. These should be handled with care and are definitely not suitable for children! (No joke!)</p>

<p><b>K-26-C</b> Sphere magnet Ø 26 mm, holds approx. 9.1 kg Weight: 70 g Chrome-plated (Ni-Cu-Ni-Cr) Magnetisation: N38 strength: approx. 9.1 kg</p>	<p>Price in CHF</p> <p>1 pc. 15.20 ea. from 3 pcs. 14.05 ea. from 10 pcs. 13.00 ea. from 20 pcs. 12.45 ea. from 40 pcs. 12.00 ea.</p>	<p>We are definitely in the area of the absurd here. None of the women I know can separate these two magnetic spheres - except for this one alpinist...</p>
<p><b>K-30-C</b> Sphere magnet Ø 30 mm, holds approx. 13 kg Weight: 110 g Chrome-plated (Ni-Cu-Ni-Cr) Magnetisation: N40 strength: approx. 13 kg</p>	<p>Price in CHF</p> <p>1 pc. 21.65 ea. from 3 pcs. 20.30 ea. from 10 pcs. 19.15 ea. from 20 pcs. 18.60 ea. from 40 pcs. 18.10 ea.</p>	<p>A diameter of 30 mm is actually an absurd size for sphere magnets - each sphere has an adhesive force of over 13 kg! The surface coating will not last forever, since the point-shaped contact areas are exposed to enormous force.</p>
<p><b>K-40-C</b> Sphere magnet Ø 40 mm, holds approx. 23 kg Weight: 250 g Chrome-plated (Ni-Cu-Ni-Cr) Magnetisation: N40 strength: approx. 23 kg</p>	<p>Price in CHF</p> <p>1 pc. 58.40 ea. from 3 pcs. 54.35 ea. from 10 pcs. 50.70 ea. from 20 pcs. 48.95 ea. from 40 pcs. 47.35 ea.</p>	<p>A single sphere has an adhesive force of over 23 kg! It is practically impossible to separate two of these magnets by hand - you would need the help of a table edge.</p>

## Ring magnets neodymium

Most ring magnets have their north and south poles on the even circular surfaces (axial magnetisation). The few exceptions that are diametrically magnetised are especially marked.

<p><b>R-06-02-02-G</b> Ring magnet Ø 6/2 mm, height 2 mm, holds approx. 760 g Weight: 0.38 g Gold-plated (Ni-Cu-Ni-Au) Magnetisation: N45 strength: approx. 760 g</p>	<p>Price in CHF</p> <p>10 pcs. 0.37 ea. from 40 pcs. 0.31 ea. from 80 pcs. 0.28 ea. from 160 pcs. 0.26 ea.</p>	<p>A genuine gold-plated little ring magnet that is surprisingly strong for its small size.</p> <p>What do women say about this one? "Adorable!"</p>
<p><b>R-06-02-02-N</b> Ring magnet Ø 6/2 mm, height 2 mm, holds approx. 760 g Weight: 0.38 g Nickel-plated (Ni-Cu-Ni) Magnetisation: N45 strength: approx. 760 g</p>	<p>Price in CHF</p> <p>10 pcs. 0.30 ea. from 40 pcs. 0.24 ea. from 80 pcs. 0.22 ea. from 160 pcs. 0.20 ea.</p>	
<p><b>R-08-02-06-N</b> Ring magnet Ø 8/2 mm, height 6 mm, holds approx. 2.4 kg Weight: 2.1 g Nickel-plated (Ni-Cu-Ni) Magnetisation: N50 strength: approx. 2.4 kg</p>	<p>Price in CHF</p> <p>5 pcs. 0.69 ea. from 15 pcs. 0.60 ea. from 40 pcs. 0.53 ea. from 80 pcs. 0.49 ea.</p>	
<p><b>R-09-07-11-N</b> Ring magnet Ø 9/7 mm, height 11 mm, holds approx. 1.5 kg Weight: 2.1 g Nickel-plated (Ni-Cu-Ni) Magnetisation: N50 strength: approx. 1.5 kg</p>	<p>Price in CHF</p> <p>5 pcs. 1.42 ea. from 15 pcs. 1.25 ea. from 40 pcs. 1.12 ea. from 80 pcs. 1.04 ea.</p>	
<p><b>R-10-04-05-G</b> Ring magnet Ø 10/4 mm, height 5 mm, holds approx. 2.5 kg Weight: 2.5 g Gold-plated (Ni-Cu-Ni-Au) Magnetisation: N42 strength: approx. 2.5 kg</p>	<p>Price in CHF</p> <p>5 pcs. 0.91 ea. from 15 pcs. 0.79 ea. from 40 pcs. 0.70 ea. from 80 pcs. 0.65 ea.</p>	<p>Gold-plated ring magnets with an adhesive force of 2.5 kg. As with almost all of our ring magnets, the poles are located on the flat circular areas. This is called axial magnetisation.</p>
<p><b>R-10-04-05-N</b> Ring magnet Ø 10/4 mm, height 5 mm, holds approx. 2.5 kg Weight: 2.5 g Nickel-plated (Ni-Cu-Ni) Magnetisation: N42 strength: approx. 2.5 kg</p>	<p>Price in CHF</p> <p>5 pcs. 0.75 ea. from 15 pcs. 0.65 ea. from 40 pcs. 0.58 ea. from 80 pcs. 0.54 ea.</p>	
<p><b>R-10-04-10-N</b> Ring magnet Ø 10/4 mm, height 10 mm, holds approx. 3.1 kg Weight: 5 g Nickel-plated (Ni-Cu-Ni) Magnetisation: N42 strength: approx. 3.1 kg</p>	<p>Price in CHF</p> <p>5 pcs. 1.11 ea. from 15 pcs. 0.99 ea. from 40 pcs. 0.89 ea. from 80 pcs. 0.84 ea.</p>	
<p><b>R-10-04-15-N</b> Ring magnet Ø 10/4 mm, height 15 mm, holds approx. 3.3 kg Weight: 7.5 g Nickel-plated (Ni-Cu-Ni) Magnetisation: N42 strength: approx. 3.3 kg</p>	<p>Price in CHF</p> <p>1 pc. 1.85 ea. from 3 pcs. 1.60 ea. from 10 pcs. 1.40 ea. from 20 pcs. 1.30 ea. from 40 pcs. 1.25 ea.</p>	

<p><b>R-10-05-05-DN</b> Ring magnet Ø 10/5 mm, height 5 mm, holds approx. 700 g Weight: 2.2 g Nickel-plated (Ni-Cu-Ni) Magnetisation: N45 strength: approx. 700 g</p>	<p>Price in CHF</p> <p>5 pcs. 0.92 ea. from 15 pcs. 0.80 ea. from 40 pcs. 0.72 ea. from 80 pcs. 0.67 ea.</p>	<p>Diametrically magnetised!</p>
<p><b>R-10-07-03-DN</b> Ring magnet Ø 10/7 mm, height 3 mm, holds approx. 400 g Weight: 0.91 g Nickel-plated (Ni-Cu-Ni) Magnetisation: N45 strength: approx. 400 g</p>	<p>Price in CHF</p> <p>5 pcs. 0.72 ea. from 15 pcs. 0.63 ea. from 40 pcs. 0.56 ea. from 80 pcs. 0.51 ea.</p>	<p>Diametrically magnetised!</p>
<p><b>R-12-05-12-N</b> Ring magnet Ø 12/5 mm, height 12 mm, holds approx. 4.4 kg Weight: 8.5 g Nickel-plated (Ni-Cu-Ni) Magnetisation: N42 strength: approx. 4.4 kg</p>	<p>Price in CHF</p> <p>1 pc. 2.15 ea. from 3 pcs. 1.85 ea. from 10 pcs. 1.60 ea. from 20 pcs. 1.50 ea. from 40 pcs. 1.40 ea.</p>	
<p><b>R-12-09-1.5-N</b> Ring magnet Ø 12/9 mm, height 1.5 mm, holds approx. 1.5 kg Weight: 0.56 g Nickel-plated (Ni-Cu-Ni) Magnetisation: N45 strength: approx. 1.5 kg</p>	<p>Price in CHF</p> <p>10 pcs. 0.51 ea. from 40 pcs. 0.43 ea. from 80 pcs. 0.40 ea. from 160 pcs. 0.37 ea.</p>	
<p><b>R-15-06-06-N</b> Ring magnet Ø 15/6 mm, height 6 mm, holds approx. 5.1 kg Weight: 6.8 g Nickel-plated (Ni-Cu-Ni) Magnetisation: N42 strength: approx. 5.1 kg</p>	<p>Price in CHF</p> <p>1 pc. 1.90 ea. from 3 pcs. 1.70 ea. from 10 pcs. 1.45 ea. from 20 pcs. 1.35 ea. from 40 pcs. 1.30 ea.</p>	<p>This neodymium ring magnet is one of our top sellers.</p>
<p><b>R-19-09-06-N</b> Ring magnet Ø 19.1/9.5 mm, height 6.4 mm, holds approx. 7.5 kg Weight: 10 g Nickel-plated (Ni-Cu-Ni) Magnetisation: N42 strength: approx. 7.5 kg</p>	<p>Price in CHF</p> <p>1 pc. 2.80 ea. from 3 pcs. 2.45 ea. from 10 pcs. 2.15 ea. from 20 pcs. 2.00 ea. from 40 pcs. 1.90 ea.</p>	<p>This neodymium ring magnet with an adhesive force of about 7.5 kg is one of our top sellers. Two ring magnets repel each other vertically by approx. 5 cm - see photos.</p>
<p><b>R-20-04-05-N</b> Ring magnet Ø 20/4.2 mm, height 5 mm, holds approx. 7.2 kg Weight: 11 g Nickel-plated (Ni-Cu-Ni) Magnetisation: N45 strength: approx. 7.2 kg</p>	<p>Price in CHF</p> <p>1 pc. 2.45 ea. from 3 pcs. 2.15 ea. from 10 pcs. 1.90 ea. from 20 pcs. 1.75 ea. from 40 pcs. 1.65 ea.</p>	
<p><b>R-25-04-05-N</b> Ring magnet Ø 25/4.2 mm, height 5 mm, holds approx. 9.4 kg Weight: 18 g Nickel-plated (Ni-Cu-Ni) Magnetisation: N45 strength: approx. 9.4 kg</p>	<p>Price in CHF</p> <p>1 pc. 3.90 ea. from 3 pcs. 3.45 ea. from 10 pcs. 3.05 ea. from 20 pcs. 2.85 ea. from 40 pcs. 2.70 ea.</p>	
<p><b>R-27-16-05-N</b> Ring magnet Ø 26.75/16 mm, height 5 mm, holds approx. 11 kg Weight: 14 g Nickel-plated (Ni-Cu-Ni) Magnetisation: N42 strength: approx. 11 kg</p>	<p>Price in CHF</p> <p>1 pc. 3.30 ea. from 3 pcs. 2.90 ea. from 10 pcs. 2.55 ea. from 20 pcs. 2.40 ea. from 40 pcs. 2.25 ea.</p>	

<b>R-40-23-06-N</b> Ring magnet Ø 40/23 mm, height 6 mm, holds approx. 21 kg Weight: 38 g Nickel-plated (Ni-Cu-Ni) Magnetisation: N42 strength: approx. 21 kg	Price in CHF 1 pc. 8.55 ea. from 3 pcs. 7.60 ea. from 10 pcs. 6.75 ea. from 20 pcs. 6.30 ea. from 40 pcs. 5.95 ea.	This is the largest of our "normal" ring magnets. With an adhesive force of over 20 kg it is a fierce magnet - please handle with care.
<b>R-60-06-30-N</b> Ring magnet Ø 60/6 mm, height 30 mm, holds approx. 120 kg Weight: 640 g Nickel-plated (Ni-Cu-Ni) Magnetisation: N45 strength: approx. 120 kg	Price in CHF 1 pc. 77.55 ea. from 3 pcs. 70.65 ea. from 10 pcs. 64.50 ea. from 20 pcs. 61.50 ea. from 40 pcs. 58.85 ea.	Giant ring (actually closer to a disc with a drill hole), that is suitable for tying with a piece of cord. You can use this to fish your bicycle (and who knows what else) out of the canal.

## Cone magnets neodymium

These neodymium magnets are cone-shaped. On the small circular area the magnetic field lines are bundled, which gives the magnets a very high adhesive force. They are perfectly suitable for whiteboards, magnetic boards, etc. The stump holds notes securely and it can be easily removed by pulling it off to the side. If the base is attached to a metal surface, however, it is hard to remove.

<p><b>CN-10-05-04-N</b> Cone magnet Ø 10/5 mm, height 4 mm, holds approx. 1.2 kg Weight: 1.4 g Nickel-plated (Ni-Cu-Ni) Magnetisation: N45 strength: approx. 1.2 kg Sticks to whiteboard: 13 A4 sheets Colour: Silver-coloured</p>	<p>Price in CHF</p> <p>5 pcs. 0.76 ea. from 15 pcs. 0.68 ea. from 40 pcs. 0.62 ea. from 120 pcs. 0.56 ea.</p>	<p>These cone magnets are neodymium magnets with special features: The magnetic flux lines are bundled on the small circular surface, and therefore the magnets possess a high adhesive force. The north pole is located on the small circular surface.</p>
<p><b>CN-15-08-06-N</b> Cone magnet Ø 15/8 mm, height 6 mm, holds approx. 3.1 kg Weight: 4.9 g Nickel-plated (Ni-Cu-Ni) Magnetisation: N42 strength: approx. 3.1 kg Sticks to whiteboard: 20 A4 sheets Colour: Silver-coloured</p>	<p>Price in CHF</p> <p>1 pc. 1.70 ea. from 3 pcs. 1.55 ea. from 10 pcs. 1.35 ea. from 40 pcs. 1.25 ea. from 80 pcs. 1.15 ea.</p>	<p>These cone magnets are neodymium magnets with special features: The magnetic flux lines are bundled on the small circular surface, and therefore the magnets possess a high adhesive force. The north pole is located on the small circular surface.</p>
<p><b>CN-20-10-08-N</b> Cone magnet Ø 20/10 mm, height 8 mm, holds approx. 4.9 kg Weight: 11 g Nickel-plated (Ni-Cu-Ni) Magnetisation: N38 strength: approx. 4.9 kg Sticks to whiteboard: 25 A4 sheets Colour: Silver-coloured</p>	<p>Price in CHF</p> <p>1 pc. 2.90 ea. from 3 pcs. 2.65 ea. from 10 pcs. 2.45 ea. from 40 pcs. 2.25 ea. from 80 pcs. 2.15 ea.</p>	<p>These cone magnets are neodymium magnets with special features: The magnetic flux lines are bundled on the small circular surface, and therefore the magnets possess a high adhesive force. The north pole is located on the small circular surface.</p>
<p><b>CN-25-13-10-N</b> Cone magnet Ø 25/13 mm, height 10 mm, holds approx. 8.6 kg Weight: 22 g Nickel-plated (Ni-Cu-Ni) Magnetisation: N38 strength: approx. 8.6 kg Sticks to whiteboard: 35 A4 sheets Colour: Silver-coloured</p>	<p>Price in CHF</p> <p>1 pc. 4.30 ea. from 3 pcs. 3.90 ea. from 10 pcs. 3.55 ea. from 40 pcs. 3.20 ea. from 80 pcs. 3.05 ea.</p>	<p>These cone magnets are neodymium magnets with special features: The magnetic flux lines are bundled on the small circular surface, and therefore the magnets possess a high adhesive force. The north pole is located on the small circular surface.</p>



## Waterproof neodymium magnets: rustproof & with scratch protection

The neodymium magnets in this group are entirely coated by a layer of rubber, which provides the following advantages:

Scratch protection: Delicate surfaces, such as whiteboards or magnetic glass boards, are well protected

Waterproof: These magnets are rustproof and can be used outdoors as long as the rubber coating stays intact

Friction: The rubber coat substantially increases the magnetic adhesive force in shear direction

Due to the rubber coating the maximum adhesive force of these magnets is slightly lower, however, compared to similar-sized neodymium magnets without coating.

<p><b>S-15-03-R</b> Disc magnet rubber coated Ø 16.8 mm, height 4.4 mm water-proof, neodymium, N45 Weight: 4 g strength: approx. 1.5 kg</p>	<p>Price in CHF</p> <p>5 pcs. 1.45 ea. from 15 pcs. 1.29 ea. from 40 pcs. 1.16 ea. from 80 pcs. 1.09 ea.</p>	<p>These neodymium magnets feature a rubber coating and are suitable for permanent outdoor or underwater use.</p>
<p><b>S-15-08-R</b> Disc magnet rubber coated Ø 16.8 mm, height 9.4 mm water-proof, neodymium, N42 Weight: 11 g strength: approx. 3.7 kg</p>	<p>Price in CHF</p> <p>1 pc. 3.40 ea. from 3 pcs. 3.00 ea. from 10 pcs. 2.65 ea. from 20 pcs. 2.50 ea. from 40 pcs. 2.35 ea.</p>	<p>These neodymium magnets feature a rubber coating and are suitable for permanent outdoor or underwater use.</p>
<p><b>S-20-05-R</b> Disc magnet rubber coated Ø 22 mm, height 6.4 mm water-proof, neodymium, N42 Weight: 12 g strength: approx. 3.9 kg</p>	<p>Price in CHF</p> <p>1 pc. 3.20 ea. from 3 pcs. 2.80 ea. from 10 pcs. 2.50 ea. from 20 pcs. 2.30 ea. from 40 pcs. 2.15 ea.</p>	<p>These neodymium magnets feature a rubber coating and are suitable for permanent outdoor or underwater use.</p>
<p><b>S-20-10-R</b> Disc magnet rubber coated Ø 22 mm, height 11.4 mm water-proof, neodymium, N42 Weight: 24 g strength: approx. 7.1 kg</p>	<p>Price in CHF</p> <p>1 pc. 4.95 ea. from 3 pcs. 4.50 ea. from 10 pcs. 4.10 ea. from 20 pcs. 3.90 ea. from 40 pcs. 3.75 ea.</p>	<p>These neodymium magnets feature a rubber coating and are suitable for permanent outdoor or underwater use.</p>

## Self-adhesive neodymium magnets

Flat neodymium magnets with self-adhesive backside are perfectly suitable as latches for paper and cardboard items, name tags and other arts and crafts purposes.

<p><b>S-06-0.75-STIC</b> Disc magnet self-adhesive Ø 6 mm, height 0.75 mm, holds approx. 230 g Weight: 0.16 g Nickel-plated (Ni-Cu-Ni) Magnetisation: N35 strength: approx. 230 g Adhesive: 3M, No. 467MP Shelf life adhesive: 12 months (approx.) Path additional document: 3M_200MP_Adhesive_Family_TDS_2017.pdf Label additional document: Adhesive data sheet</p>	<p>Price in CHF 20 pcs. 0.24 ea. from 60 pcs. 0.21 ea. from 140 pcs. 0.18 ea. from 360 pcs. 0.16 ea.</p>	<p>The convenient solution if you want to glue on a disc magnet. This very flat small disc magnet (6 mm diameter, 0,75 mm thin) has a strong self-adhesive foam side.</p>
<p><b>S-08-0.75-STIC</b> Disc magnet self-adhesive Ø 8 mm, height 0.75 mm, holds approx. 320 g Weight: 0.29 g Nickel-plated (Ni-Cu-Ni) Magnetisation: N35 strength: approx. 320 g Adhesive: 3M, No. 467MP Shelf life adhesive: 12 months (approx.) Path additional document: 3M_200MP_Adhesive_Family_TDS_2017.pdf Label additional document: Adhesive data sheet</p>	<p>Price in CHF 20 pcs. 0.23 ea. from 60 pcs. 0.20 ea. from 140 pcs. 0.18 ea. from 360 pcs. 0.16 ea.</p>	<p>No more annoying holes in your designer clothing: S-08-0.75-STIC holds name tags elegantly and without safety pins.</p>
<p><b>S-9.5-0.75-STIC</b> Disc magnet self-adhesive Ø 9.5 mm, height 0.75 mm, holds approx. 380 g Weight: 0.4 g Nickel-plated (Ni-Cu-Ni) Magnetisation: N35 strength: approx. 380 g Adhesive: 3M, No. 467MP Shelf life adhesive: 12 months (approx.) Path additional document: 3M_200MP_Adhesive_Family_TDS_2017.pdf Label additional document: Adhesive data sheet</p>	<p>Price in CHF 20 pcs. 0.24 ea. from 60 pcs. 0.21 ea. from 140 pcs. 0.18 ea. from 360 pcs. 0.16 ea.</p>	<p>A convenient solution if you would like to glue on a disc magnet. This is a very flat disc magnet (9.5 mm diameter, 0.75 mm thin) with a self-adhesive side.</p>
<p><b>S-10-0.6-STIC</b> Disc magnet self-adhesive Ø 10 mm, height 0.6 mm, holds approx. 310 g Weight: 0.36 g Nickel-plated (Ni-Cu-Ni) Magnetisation: N35 strength: approx. 310 g Adhesive: 3M, No. 467MP Shelf life adhesive: 12 months (approx.) Path additional document: 3M_200MP_Adhesive_Family_TDS_2017.pdf Label additional document: Adhesive data sheet</p>	<p>Price in CHF 20 pcs. 0.26 ea. from 60 pcs. 0.22 ea. from 140 pcs. 0.20 ea. from 360 pcs. 0.18 ea.</p>	<p>A convenient solution if you would like to glue on a disc magnet. This is a very flat disc magnet (10 mm diameter, 0.6 mm thin) with a self-adhesive side.</p>
<p><b>S-10-01-STIC</b> Disc magnet self-adhesive Ø 10 mm, height 1 mm, holds approx. 540 g Weight: 0.6 g Nickel-plated (Ni-Cu-Ni) Magnetisation: N35 strength: approx. 540 g Adhesive: 3M, No. 467MP Shelf life adhesive: 12 months (approx.) Path additional document: 3M_200MP_Adhesive_Family_TDS_2017.pdf Label additional document: Adhesive data sheet</p>	<p>Price in CHF 20 pcs. 0.28 ea. from 60 pcs. 0.25 ea. from 140 pcs. 0.22 ea. from 360 pcs. 0.20 ea.</p>	<p>The convenient solution if you want to glue on the S-10-01-N. This is a flat disc magnet with a self-adhesive side. Just peel off the film and glue it on. One sales unit contains 10 magnetic pairs that attract each other.</p>
<p><b>S-12-02-FOAM</b> Disc magnet self-adhesive Ø 12 mm, height 2 mm, holds approx. 1.3 kg Weight: 1.7 g Nickel-plated (Ni-Cu-Ni) Magnetisation: N35 strength: approx. 1.3 kg Adhesive: 3M, No. 4920, 0.40 mm Shelf life adhesive: 18 months (approx.) Path additional document: data_sheet_3m_4920.pdf Label additional document: Adhesive data sheet</p>	<p>Price in CHF 20 pcs. 0.44 ea. from 60 pcs. 0.39 ea. from 140 pcs. 0.36 ea. from 360 pcs. 0.33 ea.</p>	<p>The convenient solution if you want to glue on the magnet S-12-02-N. This is a flat disc magnet with a self-adhesive side made of cushion foam. Just remove the foil and glue it on. One sales unit contains 10 magnetic pairs.</p>
<p><b>S-13-01-STIC</b> Disc magnet self-adhesive Ø 13 mm, height 1 mm, holds approx. 710 g Weight: 1 g Nickel-plated (Ni-Cu-Ni) Magnetisation: N35 strength: approx. 710 g Adhesive: 3M, No. 467MP Shelf life adhesive: 12 months (approx.) Path additional document: 3M_200MP_Adhesive_Family_TDS_2017.pdf Label additional document: Adhesive data sheet</p>	<p>Price in CHF 20 pcs. 0.35 ea. from 60 pcs. 0.31 ea. from 140 pcs. 0.28 ea. from 360 pcs. 0.26 ea.</p>	<p>The convenient solution if you want to glue on a disc magnet. This very flat disc magnet (13 mm diameter, 1 mm thin) has a strong self-adhesive foam side.</p>
<p><b>S-15-01-STIC</b> Disc magnet self-adhesive Ø 15 mm, height 1 mm, holds approx. 820 g Weight: 1.3 g Nickel-plated (Ni-Cu-Ni) Magnetisation: N35 strength: approx. 820 g Adhesive: 3M, No. 467MP Shelf life adhesive: 12 months (approx.) Path additional document: 3M_200MP_Adhesive_Family_TDS_2017.pdf Label additional document: Adhesive data sheet</p>	<p>Price in CHF 20 pcs. 0.40 ea. from 60 pcs. 0.35 ea. from 140 pcs. 0.32 ea. from 360 pcs. 0.30 ea.</p>	<p>The convenient solution if you want to glue on a disc magnet. It is a very flat disc magnet (15 mm diameter, 1 mm thin) with a self-adhesive side.</p>

<p><b>S-15-02-FOAM</b> Disc magnet self-adhesive Ø 15 mm, height 2 mm, holds approx. 1.7 kg Weight: 2.7 g Nickel-plated (Ni-Cu-Ni) Magnetisation: N35 strength: approx. 1.7 kg Adhesive: 3M, No. 4920, 0.40 mm Shelf life adhesive: 18 months (approx.) Path additional document: data_sheet_3m_4920.pdf Label additional document: Adhesive data sheet</p>	<p>Price in CHF</p> <p>10 pcs. 0.66 ea. from 40 pcs. 0.57 ea. from 80 pcs. 0.53 ea. from 160 pcs. 0.50 ea.</p>	<p>The convenient solution if you want to glue on the disc magnet S-15-02-N. This flat disc magnet (15 mm diameter, 2 mm thin) has a strong self-adhesive foam side.</p>
<p><b>S-18-01-STIC</b> Disc magnet self-adhesive Ø 18 mm, height 1 mm, holds approx. 980 g Weight: 1.9 g Nickel-plated (Ni-Cu-Ni) Magnetisation: N35 strength: approx. 980 g Adhesive: 3M, No. 467MP Shelf life adhesive: 12 months (approx.) Path additional document: 3M_200MP_Adhesive_Family_TDS_2017.pdf Label additional document: Adhesive data sheet</p>	<p>Price in CHF</p> <p>10 pcs. 0.53 ea. from 40 pcs. 0.46 ea. from 80 pcs. 0.43 ea. from 160 pcs. 0.41 ea.</p>	<p>The convenient solution if you want to glue on a disc magnet. This very flat disc magnet (18 mm diameter, 1 mm thin) has a strong self-adhesive foam side.</p>
<p><b>S-18-02-FOAM</b> Disc magnet self-adhesive Ø 18 mm, height 2 mm, holds approx. 2 kg Weight: 3.9 g Nickel-plated (Ni-Cu-Ni) Magnetisation: N35 strength: approx. 2 kg Adhesive: 3M, No. 4920, 0.40 mm Shelf life adhesive: 18 months (approx.) Path additional document: data_sheet_3m_4920.pdf Label additional document: Adhesive data sheet</p>	<p>Price in CHF</p> <p>10 pcs. 0.84 ea. from 40 pcs. 0.73 ea. from 80 pcs. 0.69 ea. from 160 pcs. 0.66 ea.</p>	<p>The convenient solution if you want to glue on a disc magnet. This flat disc magnet (18 mm diameter, 2 mm thin) has a strong self-adhesive foam side.</p>
<p><b>S-20-01-STIC</b> Disc magnet self-adhesive Ø 20 mm, height 1 mm, holds approx. 1.1 kg Weight: 2.4 g Nickel-plated (Ni-Cu-Ni) Magnetisation: N35 strength: approx. 1.1 kg Adhesive: 3M, No. 467MP Shelf life adhesive: 12 months (approx.) Path additional document: 3M_200MP_Adhesive_Family_TDS_2017.pdf Label additional document: Adhesive data sheet</p>	<p>Price in CHF</p> <p>10 pcs. 0.57 ea. from 40 pcs. 0.49 ea. from 80 pcs. 0.45 ea. from 160 pcs. 0.42 ea.</p>	<p>The convenient solution if you want to glue on a disc magnet. It is a very flat disc magnet (15 mm diameter, 1 mm thin) with a self-adhesive side.</p>
<p><b>S-20-02-FOAM</b> Disc magnet self-adhesive Ø 20 mm, height 2 mm, holds approx. 2.3 kg Weight: 4.8 g Nickel-plated (Ni-Cu-Ni) Magnetisation: N35 strength: approx. 2.3 kg Adhesive: 3M, No. 4920, 0.40 mm Shelf life adhesive: 18 months (approx.) Path additional document: data_sheet_3m_4920.pdf Label additional document: Adhesive data sheet</p>	<p>Price in CHF</p> <p>10 pcs. 0.91 ea. from 40 pcs. 0.79 ea. from 80 pcs. 0.74 ea. from 160 pcs. 0.70 ea.</p>	<p>The convenient solution if you want to glue on the magnet S-20-02-N. This is a flat disc magnet with a self-adhesive side made of cushion foam. Just remove the foil and glue it on. One sales unit contains 5 magnet pairs.</p>
<p><b>S-22-02-FOAM</b> Disc magnet self-adhesive Ø 22 mm, height 2 mm, holds approx. 2.5 kg Weight: 5.8 g Nickel-plated (Ni-Cu-Ni) Magnetisation: N35 strength: approx. 2.5 kg Adhesive: 3M, No. 4920, 0.40 mm Shelf life adhesive: 18 months (approx.) Path additional document: data_sheet_3m_4920.pdf Label additional document: Adhesive data sheet</p>	<p>Price in CHF</p> <p>10 pcs. 0.93 ea. from 40 pcs. 0.82 ea. from 80 pcs. 0.77 ea. from 160 pcs. 0.72 ea.</p>	<p>This very flat disc magnet (22 mm diameter, 2 mm thick) has a very strong self-adhesive foam side and a remarkable adhesive force of approx. 2,5 kg.</p>
<p><b>S-25-02-FOAM</b> Disc magnet self-adhesive Ø 25 mm, height 2 mm, holds approx. 2.9 kg Weight: 7.5 g Nickel-plated (Ni-Cu-Ni) Magnetisation: N35 strength: approx. 2.9 kg Adhesive: 3M, No. 4920, 0.40 mm Shelf life adhesive: 18 months (approx.) Path additional document: data_sheet_3m_4920.pdf Label additional document: Adhesive data sheet</p>	<p>Price in CHF</p> <p>10 pcs. 1.29 ea. from 40 pcs. 1.14 ea. from 80 pcs. 1.08 ea. from 160 pcs. 1.02 ea.</p>	<p>This very flat disc magnet (25 mm diameter, 2 mm thick) has a very strong self-adhesive foam side and a remarkable adhesive force of about 3 kg.</p>
<p><b>Q-10-05-01-STIC</b> Block magnet self-adhesive 10 x 5 x 1 mm, holds approx. 500 g Weight: 0.38 g Nickel-plated (Ni-Cu-Ni) Magnetisation: N35 strength: approx. 500 g Adhesive: 3M, No. 467MP Shelf life adhesive: 12 months (approx.) Path additional document: 3M_200MP_Adhesive_Family_TDS_2017.pdf Label additional document: Adhesive data sheet</p>	<p>Price in CHF</p> <p>40 pcs. 0.22 ea. from 120 pcs. 0.19 ea. from 280 pcs. 0.17 ea. from 640 pcs. 0.15 ea.</p>	<p>A convenient solution if you want to glue on a block magnet. This is a very flat block magnet (10 mm long, 5 mm wide, 1 mm thin) with a self-adhesive side.</p>
<p><b>Q-10-10-01-STIC</b> Block magnet self-adhesive 10 x 10 x 1 mm, holds approx. 500 g Weight: 0.76 g Nickel-plated (Ni-Cu-Ni) Magnetisation: N35 strength: approx. 500 g Adhesive: 3M, No. 467MP Shelf life adhesive: 12 months (approx.) Path additional document: 3M_200MP_Adhesive_Family_TDS_2017.pdf Label additional document: Adhesive data sheet</p>	<p>Price in CHF</p> <p>20 pcs. 0.33 ea. from 60 pcs. 0.29 ea. from 140 pcs. 0.26 ea. from 360 pcs. 0.24 ea.</p>	<p>The convenient solution if you want to glue on the block magnet. This is a very flat block magnet (10 mm long, 10 mm wide, 1 mm thin) with a self-adhesive side.</p>

<p><b>Q-15-08-01-STIC</b> Block magnet self-adhesive 15 x 8 x 1 mm, holds approx. 600 g Weight: 0.91 g Nickel-plated (Ni-Cu-Ni) Magnetisation: N35 strength: approx. 600 g Adhesive: 3M, No. 467MP Shelf life adhesive: 12 months (approx.) Path additional document: 3M_200MP_Adhesive_Family_TDS_2017.pdf Label additional document: Adhesive data sheet</p>	<p>Price in CHF</p> <p>20 pcs. 0.32 ea. from 60 pcs. 0.28 ea. from 140 pcs. 0.25 ea. from 360 pcs. 0.23 ea.</p>	<p>The convenient solution if you would like to glue on block magnets. This is a very flat block magnet (15 mm long, 8 mm wide, 1 mm thin) with a self-adhesive side.</p>
<p><b>Q-20-10-01-STIC</b> Block magnet self-adhesive 20 x 10 x 1 mm, holds approx. 800 g Weight: 1.5 g Nickel-plated (Ni-Cu-Ni) Magnetisation: N35 strength: approx. 800 g Adhesive: 3M, No. 467MP Shelf life adhesive: 12 months (approx.) Path additional document: 3M_200MP_Adhesive_Family_TDS_2017.pdf Label additional document: Adhesive data sheet</p>	<p>Price in CHF</p> <p>20 pcs. 0.44 ea. from 60 pcs. 0.39 ea. from 140 pcs. 0.36 ea. from 360 pcs. 0.33 ea.</p>	<p>A convenient solution if you want to glue on a block magnet. This is a very flat block magnet (20 mm long, 10 mm wide, 1 mm thin) with a self-adhesive side.</p>
<p><b>Q-20-20-01-STIC</b> Block magnet self-adhesive 20 x 20 x 1 mm, holds approx. 1.1 kg Weight: 3 g Nickel-plated (Ni-Cu-Ni) Magnetisation: N35 strength: approx. 1.1 kg Adhesive: 3M, No. 467MP Shelf life adhesive: 12 months (approx.) Path additional document: 3M_200MP_Adhesive_Family_TDS_2017.pdf Label additional document: Adhesive data sheet</p>	<p>Price in CHF</p> <p>10 pcs. 0.68 ea. from 40 pcs. 0.59 ea. from 80 pcs. 0.55 ea. from 160 pcs. 0.52 ea.</p>	<p>The convenient solution if you want to glue on a block magnet. This is a very flat block magnet (20 mm long, 20 mm wide, 1 mm thin) with a self-adhesive side.</p>
<p><b>Q-25-12-01-STIC</b> Block magnet self-adhesive 25 x 12 x 1 mm, holds approx. 1 kg Weight: 2.3 g Nickel-plated (Ni-Cu-Ni) Magnetisation: N35 strength: approx. 1 kg Adhesive: 3M, No. 467MP Shelf life adhesive: 12 months (approx.) Path additional document: 3M_200MP_Adhesive_Family_TDS_2017.pdf Label additional document: Adhesive data sheet</p>	<p>Price in CHF</p> <p>20 pcs. 0.71 ea. from 60 pcs. 0.63 ea. from 140 pcs. 0.57 ea. from 360 pcs. 0.52 ea.</p>	<p>The convenient solution if you want to glue on a block magnet. This is a very flat block magnet (25 mm long, 12 mm wide, 1 mm thin) with a self-adhesive side.</p>
<p><b>Q-30-10-01-STIC</b> Block magnet self-adhesive 30 x 10 x 1 mm, holds approx. 1 kg Weight: 2.3 g Nickel-plated (Ni-Cu-Ni) Magnetisation: N35 strength: approx. 1 kg Adhesive: 3M, No. 467MP Shelf life adhesive: 12 months (approx.) Path additional document: 3M_200MP_Adhesive_Family_TDS_2017.pdf Label additional document: Adhesive data sheet</p>	<p>Price in CHF</p> <p>20 pcs. 0.59 ea. from 60 pcs. 0.53 ea. from 140 pcs. 0.49 ea. from 360 pcs. 0.45 ea.</p>	<p>A convenient solution if you would like to glue on a block magnet. This is a very flat block magnet (30 mm long, 10 mm wide, 1 mm thin) with a self-adhesive side.</p>
<p><b>Q-40-12-01-STIC</b> Block magnet self-adhesive 40 x 12 x 1 mm, holds approx. 1.2 kg Weight: 3.6 g Nickel-plated (Ni-Cu-Ni) Magnetisation: N35 strength: approx. 1.2 kg Adhesive: 3M, No. 467MP Shelf life adhesive: 12 months (approx.) Path additional document: 3M_200MP_Adhesive_Family_TDS_2017.pdf Label additional document: Adhesive data sheet</p>	<p>Price in CHF</p> <p>20 pcs. 0.83 ea. from 60 pcs. 0.74 ea. from 140 pcs. 0.68 ea. from 360 pcs. 0.63 ea.</p>	<p>A convenient solution if you would like to glue on a block magnet. This is a very flat block magnet (40 mm long, 12 mm wide, 1 mm thin) with a self-adhesive side.</p>

## Magnet sets

Please note: Due to the dangers of swallowing magnets, the magnets in this set are not suitable as toys for small children and must be kept out of their reach! If two or more magnets are swallowed they can get caught in the intestines and cause life-threatening injuries.

<b>Z-10</b> Macho set magnet set case with 40 super magnets Weight: 1.4 kg/set	Price in CHF 1 set 59.95/set	For people who aren't easily impressed, we now have the supermagnete macho set! 10 large and 30 small super magnets in one tool case.
<b>Z-04</b> Magnet set 114 set with 114 small neodymium magnets Weight: 59 g/set	Price in CHF 1 set 18.55/set from 3 sets 16.80/set from 10 sets 15.25/set from 20 sets 14.45/set from 40 sets 13.80/set	Set with 114 super magnets! You'll receive 30 pcs Q-05-05-02-G, 30 pcs. S-06-02-N, 30 pcs. R-06-02-02-G, 12 pcs. W-05-N, 12 pcs. W-05-G. Purchased singly, these 114 magnets cost almost twice the price - a hit price!

## Sew-in magnets neodymium

Flat neodymium disc magnets, shrink-wrapped in sturdy plastic foil, to sew into clothing. Thanks to the plastic covering, the magnets are waterproof and rustproof and can be washed and used outdoors and in wet surroundings.

<p><b>M-SEW-01</b> Sew-in magnets 12 x 2 mm angular, holds approx. 1.2 kg water-proof with square PVC cover Weight: 2 g strength: approx. 1.2 kg</p>	<p>Price in CHF 20 pcs. 0.58 ea. from 60 pcs. 0.55 ea. from 140 pcs. 0.53 ea. from 360 pcs. 0.51 ea.</p>	<p>These are disc magnets (12 x 2 mm) with an adhesive force of approximately 1 kg, shrink-wrapped into a square PVC cover. They can be sewn into clothing or used in wet surroundings without rusting.</p>
<p><b>M-SEW-02</b> Sew-in magnets 12 x 2 mm round, holds approx. 1.2 kg water-proof with circular PVC cover Weight: 2 g strength: approx. 1.2 kg</p>	<p>Price in CHF 20 pcs. 0.63 ea. from 60 pcs. 0.60 ea. from 140 pcs. 0.58 ea. from 360 pcs. 0.56 ea.</p>	<p>These are disc magnets (12 x 2 mm) with an adhesive force of approximately 1 kg, shrink-wrapped into a round PVC cover. They can be sewn into clothing or used in wet surroundings without rusting.</p>
<p><b>M-SEW-03</b> Sew-in magnets 18 x 2 mm angular, holds approx. 1.9 kg water-proof with square PVC cover Weight: 4 g strength: approx. 1.9 kg</p>	<p>Price in CHF 10 pcs. 0.86 ea. from 40 pcs. 0.82 ea. from 80 pcs. 0.80 ea. from 160 pcs. 0.78 ea.</p>	<p>These are disc magnets (18 x 2 mm) with an adhesive force of almost 2 kg, shrink-wrapped into a square PVC cover. They can be sewn into clothing or used in wet surroundings without rusting.</p>
<p><b>M-SEW-04</b> Sew-in magnets 18 x 2 mm round, holds approx. 1.9 kg water-proof with circular PVC cover Weight: 4 g strength: approx. 1.9 kg</p>	<p>Price in CHF 10 pcs. 0.92 ea. from 40 pcs. 0.87 ea. from 80 pcs. 0.85 ea. from 160 pcs. 0.83 ea.</p>	<p>These are disc magnets (18 x 2 mm) with an adhesive force of almost 2 kg, shrink-wrapped into a round PVC cover. They can be sewn into clothing or used in wet surroundings without rusting.</p>

## Screw-on neodymium magnets

Flat countersunk neodymium disc and block magnets with one or two holes can be fastened with a countersunk head screw. They are only 4 mm thick and therefore very discreet for hanging up signs, tools, etc. Screw-on magnets are very popular in the areas of kitchen installations, booth and store construction, signage technology, furniture manufacturing, etc.

<p><b>CS-S-12-04-N</b> Disc magnet Ø 12 mm, height 4 mm with countersunk hole N35, nickel-plated Weight: 2.5 g strength: approx. 1.6 kg</p>	<p>Price in CHF</p> <p>5 pcs. 0.90 ea. from 15 pcs. 0.78 ea. from 40 pcs. 0.69 ea. from 80 pcs. 0.64 ea.</p>	<p>Diameter D: 12 mm Height H: 4 mm Hole d1: 4.5 mm Hole d2: 9.46 mm Countersink t: 2.48 mm Tolerance: +/- 0.1 mm</p>
<p><b>CS-S-15-04-N</b> Disc magnet Ø 15 mm, height 4 mm with countersunk hole N35, nickel-plated Weight: 4 g strength: approx. 3 kg</p>	<p>Price in CHF</p> <p>5 pcs. 1.03 ea. from 15 pcs. 0.91 ea. from 40 pcs. 0.82 ea. from 80 pcs. 0.76 ea.</p>	<p>Diameter D: 15 mm Height H: 4 mm Hole d1: 4.5 mm Hole d2: 9.46 mm Countersink t: 2.48 mm Tolerance: +/- 0.1 mm</p>
<p><b>CS-S-18-04-N</b> Disc magnet Ø 18 mm, height 4 mm with countersunk hole N35, nickel-plated Weight: 6.3 g strength: approx. 4 kg</p>	<p>Price in CHF</p> <p>5 pcs. 1.47 ea. from 15 pcs. 1.30 ea. from 40 pcs. 1.18 ea. from 80 pcs. 1.10 ea.</p>	<p>Diameter D: 18 mm Height H: 4 mm Hole d1: 4.5 mm Hole d2: 9.46 mm Countersink t: 2.48 mm Tolerance: +/- 0.1 mm</p>
<p><b>CS-S-23-04-N</b> Disc magnet Ø 23 mm, height 4 mm with countersunk hole N35, nickel-plated Weight: 11 g strength: approx. 6.5 kg</p>	<p>Price in CHF</p> <p>1 pc. 2.05 ea. from 3 pcs. 1.80 ea. from 10 pcs. 1.60 ea. from 20 pcs. 1.50 ea. from 40 pcs. 1.40 ea.</p>	<p>Diameter D: 23 mm Height H: 4 mm Hole d1: 4.5 mm Hole d2: 9.46 mm Countersink t: 2.48 mm Tolerance: +/- 0.1 mm</p>
<p><b>CS-S-27-04-N</b> Disc magnet Ø 27 mm, height 4 mm with countersunk hole N35, nickel-plated Weight: 16 g strength: approx. 8 kg</p>	<p>Price in CHF</p> <p>1 pc. 2.95 ea. from 3 pcs. 2.65 ea. from 10 pcs. 2.35 ea. from 20 pcs. 2.20 ea. from 40 pcs. 2.05 ea.</p>	<p>Diameter D: 27 mm Height H: 4 mm Hole d1: 4.5 mm Hole d2: 9.46 mm Countersink t: 2.48 mm Tolerance: +/- 0.1 mm</p>
<p><b>CS-S-34-04-N</b> Disc magnet Ø 34 mm, height 4 mm with countersunk hole N35, nickel-plated Weight: 27 g strength: approx. 10 kg</p>	<p>Price in CHF</p> <p>1 pc. 3.70 ea. from 3 pcs. 3.30 ea. from 10 pcs. 2.95 ea. from 20 pcs. 2.75 ea. from 40 pcs. 2.60 ea.</p>	<p>Diameter D: 34 mm Height H: 4 mm Hole d1: 4.5 mm Hole d2: 9.46 mm Countersink t: 2.48 mm Tolerance: +/- 0.1 mm</p>
<p><b>CS-S-42-04-N</b> Disc magnet Ø 42 mm, height 4 mm with countersunk hole N35, nickel-plated Weight: 35 g strength: approx. 12 kg</p>	<p>Price in CHF</p> <p>1 pc. 5.70 ea. from 3 pcs. 5.20 ea. from 10 pcs. 4.75 ea. from 20 pcs. 4.50 ea. from 40 pcs. 4.35 ea.</p>	<p>Diameter D: 42 mm Height H: 4 mm Hole d1: 4.5 mm Hole d2: 9.46 mm Countersink t: 2.48 mm Tolerance: +/- 0.1 mm</p>
<p><b>CS-S-50-04-N</b> Disc magnet Ø 50 mm, height 4 mm with countersunk hole N35, nickel-plated Weight: 59 g strength: approx. 14 kg</p>	<p>Price in CHF</p> <p>1 pc. 6.85 ea. from 3 pcs. 6.25 ea. from 10 pcs. 5.70 ea. from 20 pcs. 5.45 ea. from 40 pcs. 5.20 ea.</p>	<p>Diameter D: 50 mm Height H: 4 mm Hole d1: 4.5 mm Hole d2: 9.46 mm Countersink t: 2.48 mm Tolerance: +/- 0.1 mm</p>

<p><b>CS-Q-12-12-04-N</b> Block magnet 12 x 12 x 4 mm with countersunk hole N35, nickel-plated Weight: 3 g strength: approx. 3 kg</p>	<p>Price in CHF</p> <p>5 pcs. 0.93 ea. from 15 pcs. 0.82 ea. from 40 pcs. 0.75 ea. from 80 pcs. 0.70 ea.</p>	<p>Length S1: 12 mm Length S2: 12 mm Height H: 4 mm Hole d1: 4.5 mm Countersink d2: 9.46 mm Countersink t: 2.48 mm</p>
<p><b>CS-Q-15-15-04-N</b> Block magnet 15 x 15 x 4 mm with countersunk hole N35, nickel-plated Weight: 5.8 g strength: approx. 4 kg</p>	<p>Price in CHF</p> <p>5 pcs. 1.47 ea. from 15 pcs. 1.30 ea. from 40 pcs. 1.18 ea. from 80 pcs. 1.10 ea.</p>	<p>Length S1: 15 mm Length S2: 15 mm Height H: 4 mm Hole d1: 4.5 mm Countersink d2: 9.46 mm Countersink t: 2.48 mm</p>
<p><b>CS-Q-20-12-04-N</b> Block magnet 20 x 12 x 4 mm with countersunk hole N35, nickel-plated Weight: 6 g strength: approx. 5.2 kg</p>	<p>Price in CHF</p> <p>5 pcs. 1.60 ea. from 15 pcs. 1.41 ea. from 40 pcs. 1.28 ea. from 80 pcs. 1.19 ea.</p>	<p>Length S1: 20 mm Length S2: 12 mm Height H: 4 mm Hole d1: 4.5 mm Countersink d2: 9.46 mm Countersink t: 2.48 mm</p>
<p><b>CS-Q-30-12-04-N</b> Block magnet 30 x 12 x 4 mm with countersunk hole N35, nickel-plated Weight: 9.5 g strength: approx. 6.8 kg</p>	<p>Price in CHF</p> <p>5 pcs. 2.30 ea. from 15 pcs. 2.03 ea. from 40 pcs. 1.83 ea. from 80 pcs. 1.71 ea.</p>	<p>Length S1: 30 mm Length S2: 12 mm Height H: 4 mm Hole d1: 4.5 mm Countersink d2: 9.46 mm Countersink t: 2.48 mm</p>
<p><b>CS-Q-20-20-04-N</b> Block magnet 20 x 20 x 4 mm with countersunk hole N35, nickel-plated Weight: 11 g strength: approx. 7.5 kg</p>	<p>Price in CHF</p> <p>1 pc. 2.65 ea. from 3 pcs. 2.30 ea. from 10 pcs. 2.00 ea. from 20 pcs. 1.90 ea. from 40 pcs. 1.75 ea.</p>	<p>Length S1: 20 mm Length S2: 20 mm Height H: 4 mm Hole d1: 4.5 mm Countersink d2: 9.46 mm Countersink t: 2.48 mm</p>
<p><b>CS-Q-40-20-04-N</b> Block magnet 40 x 20 x 4 mm with two countersunk holes N35, nickel-plated Weight: 22 g strength: approx. 12 kg</p>	<p>Price in CHF</p> <p>1 pc. 4.50 ea. from 3 pcs. 4.00 ea. from 10 pcs. 3.55 ea. from 20 pcs. 3.35 ea. from 40 pcs. 3.15 ea.</p>	<p>Length S1: 40 mm Length S2: 20 mm Height H: 4 mm Hole d1: 4.5 mm Countersink d2: 9.46 mm Countersink t: 2.48 mm</p>
<p><b>CS-Q-40-40-04-N</b> Block magnet 40 x 40 x 4 mm with two countersunk holes N35, nickel-plated Weight: 47 g strength: approx. 16 kg</p>	<p>Price in CHF</p> <p>1 pc. 6.35 ea. from 3 pcs. 5.70 ea. from 10 pcs. 5.05 ea. from 20 pcs. 4.80 ea. from 40 pcs. 4.50 ea.</p>	<p>Length S1: 40 mm Length S2: 40 mm Height H: 4 mm Hole d1: 4.5 mm Countersink d2: 9.46 mm Countersink t: 2.48 mm</p>
<p><b>CS-Q-60-20-04-N</b> Block magnet 60 x 20 x 4 mm with two countersunk holes N35, nickel-plated Weight: 34 g strength: approx. 13 kg</p>	<p>Price in CHF</p> <p>1 pc. 5.95 ea. from 3 pcs. 5.35 ea. from 10 pcs. 4.80 ea. from 20 pcs. 4.50 ea. from 40 pcs. 4.30 ea.</p>	<p>Length S1: 60 mm Length S2: 20 mm Height H: 4 mm Hole d1: 4.5 mm Countersink d2: 9.46 mm Countersink t: 2.48 mm</p>
<p><b>CS-Q-80-20-04-N</b> Block magnet 80 x 20 x 4 mm with two countersunk holes N35, nickel-plated Weight: 47 g strength: approx. 18 kg</p>	<p>Price in CHF</p> <p>1 pc. 7.80 ea. from 3 pcs. 6.95 ea. from 10 pcs. 6.20 ea. from 20 pcs. 5.80 ea. from 40 pcs. 5.50 ea.</p>	<p>Length S1: 80 mm Length S2: 20 mm Height H: 4 mm Hole d1: 4.5 mm Countersink d2: 9.46 mm Countersink t: 2.48 mm</p>



## Ferrite disc magnets

All ferrite disc magnets have their north and south poles on the even circular surfaces (axial magnetisation).

<p><b>FE-S-05-05</b> Disc magnet Ø 5 mm, height 5 mm, holds approx. 100 g Tolerance: +/- 0.1 mm, +/- 0.1 mm Weight: 0.48 g no coating Magnetisation: Y35 strength: approx. 100 g</p>	<p>Price in CHF 100 pcs. 0.15 ea. from 300 pcs. 0.13 ea. from 700 pcs. 0.12 ea. from 1600 pcs. 0.11 ea.</p>
<p><b>FE-S-10-03</b> Disc magnet Ø 10 mm, height 3 mm, holds approx. 200 g Tolerance: +/- 0.1 mm, +/- 0.1 mm Weight: 1.1 g no coating Magnetisation: Y35 strength: approx. 200 g</p>	<p>Price in CHF 20 pcs. 0.19 ea. from 60 pcs. 0.17 ea. from 140 pcs. 0.15 ea. from 360 pcs. 0.13 ea.</p>
<p><b>FE-S-10-05</b> Disc magnet Ø 10 mm, height 5 mm, holds approx. 300 g Tolerance: +/- 0.1 mm, +/- 0.1 mm Weight: 1.9 g no coating Magnetisation: Y35 strength: approx. 300 g</p>	<p>Price in CHF 20 pcs. 0.20 ea. from 60 pcs. 0.17 ea. from 140 pcs. 0.16 ea. from 360 pcs. 0.14 ea.</p>
<p><b>FE-S-10-10</b> Disc magnet Ø 10 mm, height 10 mm, holds approx. 400 g Tolerance: +/- 0.1 mm, +/- 0.1 mm Weight: 3.8 g no coating Magnetisation: Y35 strength: approx. 400 g</p>	<p>Price in CHF 10 pcs. 0.23 ea. from 40 pcs. 0.19 ea. from 80 pcs. 0.18 ea. from 160 pcs. 0.16 ea.</p>
<p><b>FE-S-100-15</b> Disc magnet Ø 100 mm, height 15 mm, holds approx. 11 kg Tolerance: +/- 2.0 mm, +/- 0.1 mm Weight: 570 g no coating Magnetisation: Y35 strength: approx. 11 kg</p>	<p>Price in CHF 1 pc. 6.65 ea. from 3 pcs. 5.95 ea. from 10 pcs. 5.30 ea. from 20 pcs. 5.00 ea. from 40 pcs. 4.70 ea.</p>
<p><b>FE-S-12-05</b> Disc magnet Ø 12 mm, height 5 mm, holds approx. 400 g Tolerance: +/- 0.1 mm, +/- 0.1 mm Weight: 2.7 g no coating Magnetisation: Y35 strength: approx. 400 g</p>	<p>Price in CHF 10 pcs. 0.21 ea. from 40 pcs. 0.17 ea. from 80 pcs. 0.15 ea. from 160 pcs. 0.14 ea.</p>
<p><b>FE-S-15-05</b> Disc magnet Ø 15 mm, height 5 mm, holds approx. 550 g Tolerance: +/- 0.1 mm, +/- 0.1 mm Weight: 4.3 g no coating Magnetisation: Y35 strength: approx. 550 g</p>	<p>Price in CHF 10 pcs. 0.24 ea. from 40 pcs. 0.20 ea. from 80 pcs. 0.19 ea. from 160 pcs. 0.17 ea.</p>
<p><b>FE-S-15-10</b> Disc magnet Ø 15 mm, height 10 mm, holds approx. 750 g Tolerance: +/- 0.1 mm, +/- 0.1 mm Weight: 8.6 g no coating Magnetisation: Y35 strength: approx. 750 g</p>	<p>Price in CHF 10 pcs. 0.25 ea. from 40 pcs. 0.21 ea. from 80 pcs. 0.19 ea. from 160 pcs. 0.18 ea.</p>

<b>FE-S-20-03</b>		Price in CHF	
Disc magnet Ø 20 mm, height 3 mm, holds approx. 400 g		15 pcs.	0.18 ea.
Tolerance: +/- 0.1 mm, +/- 0.1 mm	from	45 pcs.	0.15 ea.
Weight: 4.6 g	from	105 pcs.	0.14 ea.
no coating			
Magnetisation: Y35	from	240 pcs.	0.12 ea.
strength: approx. 400 g			
<b>FE-S-20-05</b>		Price in CHF	
Disc magnet Ø 20 mm, height 5 mm, holds approx. 700 g		10 pcs.	0.22 ea.
Tolerance: +/- 0.1 mm, +/- 0.1 mm	from	40 pcs.	0.18 ea.
Weight: 7.6 g	from	80 pcs.	0.16 ea.
no coating			
Magnetisation: Y35	from	160 pcs.	0.14 ea.
strength: approx. 700 g			
<b>FE-S-20-10</b>		Price in CHF	
Disc magnet Ø 20 mm, height 10 mm, holds approx. 1.4 kg		10 pcs.	0.32 ea.
Tolerance: +/- 0.1 mm, +/- 0.1 mm	from	40 pcs.	0.26 ea.
Weight: 15 g	from	80 pcs.	0.24 ea.
no coating			
Magnetisation: Y35	from	160 pcs.	0.22 ea.
strength: approx. 1.4 kg			
<b>FE-S-25-05</b>		Price in CHF	
Disc magnet Ø 25 mm, height 5 mm, holds approx. 800 g		10 pcs.	0.24 ea.
Tolerance: +/- 0.1 mm, +/- 0.1 mm	from	40 pcs.	0.19 ea.
Weight: 12 g	from	80 pcs.	0.17 ea.
no coating			
Magnetisation: Y35	from	160 pcs.	0.16 ea.
strength: approx. 800 g			
<b>FE-S-25-10</b>		Price in CHF	
Disc magnet Ø 25 mm, height 10 mm, holds approx. 1.5 kg		10 pcs.	0.39 ea.
Tolerance: +/- 0.1 mm, +/- 0.1 mm	from	40 pcs.	0.33 ea.
Weight: 24 g	from	80 pcs.	0.31 ea.
no coating			
Magnetisation: Y35	from	160 pcs.	0.29 ea.
strength: approx. 1.5 kg			
<b>FE-S-25-15</b>		Price in CHF	
Disc magnet Ø 25 mm, height 15 mm, holds approx. 2.3 kg		5 pcs.	0.57 ea.
Tolerance: +/- 0.1 mm, +/- 0.1 mm	from	15 pcs.	0.51 ea.
Weight: 36 g	from	40 pcs.	0.46 ea.
no coating			
Magnetisation: Y35	from	80 pcs.	0.43 ea.
strength: approx. 2.3 kg			
<b>FE-S-30-05</b>		Price in CHF	
Disc magnet Ø 30 mm, height 5 mm, holds approx. 900 g		10 pcs.	0.28 ea.
Tolerance: +/- 0.6 mm, +/- 0.1 mm	from	40 pcs.	0.23 ea.
Weight: 17 g	from	80 pcs.	0.21 ea.
no coating			
Magnetisation: Y35	from	160 pcs.	0.19 ea.
strength: approx. 900 g			
<b>FE-S-30-10</b>		Price in CHF	
Disc magnet Ø 30 mm, height 10 mm, holds approx. 2.3 kg		5 pcs.	0.49 ea.
Tolerance: +/- 0.6 mm, +/- 0.1 mm	from	15 pcs.	0.42 ea.
Weight: 34 g	from	40 pcs.	0.37 ea.
no coating			
Magnetisation: Y35	from	80 pcs.	0.34 ea.
strength: approx. 2.3 kg			
<b>FE-S-30-15</b>		Price in CHF	
Disc magnet Ø 30 mm, height 15 mm, holds approx. 3 kg		5 pcs.	0.59 ea.
Tolerance: +/- 0.6 mm, +/- 0.1 mm	from	15 pcs.	0.51 ea.
Weight: 51 g	from	40 pcs.	0.45 ea.
no coating			
Magnetisation: Y35	from	80 pcs.	0.41 ea.
strength: approx. 3 kg			

<b>FE-S-40-10</b>		Price in CHF	
Disc magnet Ø 40 mm,		5 pcs.	0.73 ea.
height 10 mm, holds approx. 2.4 kg			
Tolerance: +/- 0.8 mm, +/- 0.1 mm	from	15 pcs.	0.62 ea.
Weight: 61 g		from	40 pcs. 0.54 ea.
no coating		from	80 pcs. 0.49 ea.
Magnetisation: Y35			
strength: approx. 2.4 kg			
<b>FE-S-40-20</b>		Price in CHF	
Disc magnet Ø 40 mm,		5 pcs.	1.09 ea.
height 20 mm, holds approx. 4.7 kg			
Tolerance: +/- 0.8 mm, +/- 0.1 mm	from	15 pcs.	0.97 ea.
Weight: 120 g		from	40 pcs. 0.88 ea.
no coating		from	80 pcs. 0.82 ea.
Magnetisation: Y35			
strength: approx. 4.7 kg			
<b>FE-S-60-15</b>		Price in CHF	
Disc magnet Ø 60 mm,		5 pcs.	1.50 ea.
height 15 mm, holds approx. 4.9 kg			
Tolerance: +/- 1.2 mm, +/- 0.1 mm	from	15 pcs.	1.31 ea.
Weight: 210 g		from	40 pcs. 1.17 ea.
no coating		from	80 pcs. 1.08 ea.
Magnetisation: Y35			
strength: approx. 4.9 kg			
<b>FE-S-70-15</b>		Price in CHF	
Disc magnet Ø 70 mm,		1 pc.	2.80 ea.
height 15 mm, holds approx. 8.4 kg			
Tolerance: +/- 1.4 mm, +/- 0.1 mm	from	3 pcs.	2.45 ea.
Weight: 280 g		from	10 pcs. 2.10 ea.
no coating		from	20 pcs. 1.95 ea.
Magnetisation: Y35		from	40 pcs. 1.80 ea.
strength: approx. 8.4 kg			

## Ferrite block magnets

All ferrite block magnets have their north and south poles on the two largest surfaces.

<p><b>FE-Q-07-07-05</b> Block magnet 7 x 7 x 5 mm, holds approx. 200 g Tolerance: +/- 0.2 mm, +/- 0.2 mm, +/- 0.1mm Weight: 1.2 g no coating Magnetisation: Y35 strength: approx. 200 g</p>	<p>Price in CHF 40 pcs. 0.13 ea. from 120 pcs. 0.11 ea. from 280 pcs. 0.09 ea. from 640 pcs. 0.08 ea.</p>
<p><b>FE-Q-18-10-06</b> Block magnet 18 x 10 x 6 mm, holds approx. 630 g Tolerance: +/- 0.2 mm, +/- 0.2 mm, +/- 0.1 mm Weight: 5.2 g no coating Magnetisation: Y35 strength: approx. 630 g</p>	<p>Price in CHF 10 pcs. 0.35 ea. from 40 pcs. 0.29 ea. from 80 pcs. 0.26 ea. from 160 pcs. 0.23 ea.</p>
<p><b>FE-Q-20-20-03</b> Block magnet 20 x 20 x 3 mm, holds approx. 450 g Tolerance: +/- 0.2 mm, +/- 0.2 mm, +/- 0.1 mm Weight: 5.8 g no coating Magnetisation: Y35 strength: approx. 450 g</p>	<p>Price in CHF 10 pcs. 0.39 ea. from 40 pcs. 0.31 ea. from 80 pcs. 0.28 ea. from 160 pcs. 0.25 ea.</p>
<p><b>FE-Q-25-20-06</b> Block magnet 25 x 20 x 6 mm, holds approx. 1.2 kg Tolerance: +/- 0.5 mm, +/- 0.4 mm, +/- 0.1 mm Weight: 15 g no coating Magnetisation: Y35 strength: approx. 1.2 kg</p>	<p>Price in CHF 5 pcs. 0.50 ea. from 15 pcs. 0.42 ea. from 40 pcs. 0.36 ea. from 80 pcs. 0.33 ea.</p>
<p><b>FE-Q-30-20-06</b> Block magnet 30 x 20 x 6 mm, holds approx. 1.4 kg Tolerance: +/- 0.6 mm, +/- 0.4 mm, +/- 0.1 mm Weight: 17 g no coating Magnetisation: Y35 strength: approx. 1.4 kg</p>	<p>Price in CHF 10 pcs. 0.42 ea. from 40 pcs. 0.34 ea. from 80 pcs. 0.31 ea. from 160 pcs. 0.28 ea.</p>
<p><b>FE-Q-40-20-10</b> Block magnet 40 x 20 x 10 mm, holds approx. 2.5 kg Tolerance: +/- 0.8 mm, +/- 0.4 mm, +/- 0.1 mm Weight: 39 g no coating Magnetisation: Y35 strength: approx. 2.5 kg</p>	<p>Price in CHF 5 pcs. 0.74 ea. from 15 pcs. 0.63 ea. from 40 pcs. 0.54 ea. from 80 pcs. 0.49 ea.</p>
<p><b>FE-Q-50-50-05</b> Block magnet 50 x 50 x 5 mm, holds approx. 2 kg Tolerance: +/- 1.0 mm, +/- 1.0 mm, +/- 0.1 mm Weight: 61 g no coating Magnetisation: Y35 strength: approx. 2 kg</p>	<p>Price in CHF 5 pcs. 1.24 ea. from 15 pcs. 1.07 ea. from 40 pcs. 0.94 ea. from 80 pcs. 0.86 ea.</p>
<p><b>FE-Q-60-30-10</b> Block magnet 60 x 30 x 10 mm, holds approx. 4.1 kg Tolerance: +/- 1.2 mm, +/- 0.6 mm, +/- 0.1 mm Weight: 87 g no coating Magnetisation: Y35 strength: approx. 4.1 kg</p>	<p>Price in CHF 1 pc. 2.35 ea. from 3 pcs. 2.05 ea. from 10 pcs. 1.75 ea. from 20 pcs. 1.60 ea. from 40 pcs. 1.50 ea.</p>

## Ferrite ring magnets

All ferrite ring magnets have their south and north poles on the even circular surfaces (axial magnetisation).

<p><b>FE-R-100-60-20</b> Ring magnet Ø 100/60 mm, height 20 mm, holds approx. 16 kg Tolerance: +/- 2.0 mm, +/- 1.2 mm, +/- 0.1 mm Weight: 490 g no coating Magnetisation: Y35 strength: approx. 16 kg</p>	<p>Price in CHF</p> <p>1 pc. 3.50 ea. from 3 pcs. 3.15 ea. from 10 pcs. 2.85 ea. from 20 pcs. 2.65 ea. from 40 pcs. 2.55 ea.</p>
<p><b>FE-R-22-06-05</b> Ring magnet Ø 22/6 mm, height 5 mm, holds approx. 820 g Tolerance: +/- 0.44 mm, +/- 0.2 mm, +/- 0.1 mm Weight: 8.5 g no coating Magnetisation: Y35 strength: approx. 820 g</p>	<p>Price in CHF</p> <p>15 pcs. 0.26 ea. from 45 pcs. 0.23 ea. from 105 pcs. 0.21 ea. from 240 pcs. 0.19 ea.</p>
<p><b>FE-R-30-16-08</b> Ring magnet Ø 30/16 mm, height 8 mm, holds approx. 1.6 kg Tolerance: +/- 0.6 mm, +/- 0.32 mm, +/- 0.1 mm Weight: 20 g no coating Magnetisation: Y35 strength: approx. 1.6 kg</p>	<p>Price in CHF</p> <p>10 pcs. 0.26 ea. from 40 pcs. 0.21 ea. from 80 pcs. 0.19 ea. from 160 pcs. 0.18 ea.</p>
<p><b>FE-R-40-22-09</b> Ring magnet Ø 40/22 mm, height 9 mm, holds approx. 2.7 kg Tolerance: +/- 0.8 mm, +/- 0.44 mm, +/- 0.1 mm Weight: 38 g no coating Magnetisation: Y35 strength: approx. 2.7 kg</p>	<p>Price in CHF</p> <p>12 pcs. 0.35 ea. from 36 pcs. 0.30 ea. from 84 pcs. 0.30 ea. from 204 pcs. 0.25 ea.</p>
<p><b>FE-R-60-20-10</b> Ring magnet Ø 60/20 mm, height 10 mm, holds approx. 4 kg Tolerance: +/- 1.2 mm, +/- 0.4 mm, +/- 0.1 mm Weight: 120 g no coating Magnetisation: Y35 strength: approx. 4 kg</p>	<p>Price in CHF</p> <p>1 pc. 1.70 ea. from 3 pcs. 1.50 ea. from 10 pcs. 1.35 ea. from 20 pcs. 1.25 ea. from 40 pcs. 1.15 ea.</p>
<p><b>FE-R-80-40-15</b> Ring magnet Ø 80/40 mm, height 15 mm, holds approx. 9.5 kg Tolerance: +/- 1.6 mm, +/- 0.8 mm, +/- 0.1 mm Weight: 270 g no coating Magnetisation: Y35 strength: approx. 9.5 kg</p>	<p>Price in CHF</p> <p>1 pc. 2.45 ea. from 3 pcs. 2.15 ea. from 10 pcs. 1.95 ea. from 20 pcs. 1.80 ea. from 40 pcs. 1.70 ea.</p>

## Pot magnets with countersunk hole screw-on

Distinctive feature: These magnets can be fastened with a countersunk screw.

Principle: The magnets are embedded in a steel pot. The steel pot increases the adhesive force of the magnet on direct contact with a thick iron surface. If there is no direct contact with the counterpart, or if the steel plate is thin, painted or rough, you won't be able to put as much strain on it.

Shear force: The indicated adhesive force was measured perpendicular to the surface to which the magnet should stick. It takes a lot less strength to move the magnet sideways. Therefore, you won't be able to put as much strain on a pot magnet if you use it on a wall as opposed to using it on the ceiling.

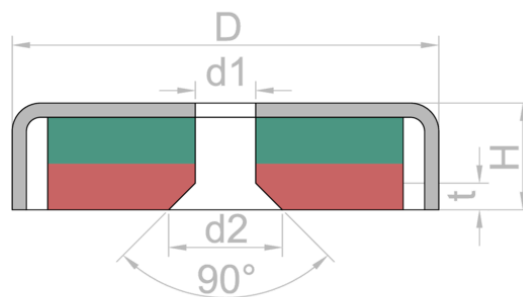

© supermagnete.com

Rust: These magnets are not rust-free and therefore intended for dry indoor use.

<p><b>CSN-10</b> Pot magnet Ø 10 mm with countersunk hole, holds approx. 1.3 kg Weight: 2 g strength: approx. 1.3 kg</p>	<p>Price in CHF</p> <p>5 pcs. 1.23 ea. from 15 pcs. 1.06 ea. from 40 pcs. 0.93 ea. from 80 pcs. 0.85 ea.</p>	<p>Diameter D: 10 mm Total height H: 4.5 mm Hole d1: 3 mm Hole d2: 4.8 mm Countersinking t: 0.9 mm Tolerance: +/- 0.1 mm</p>
<p><b>CSN-13</b> Pot magnet Ø 13 mm with countersunk hole, holds approx. 3 kg Weight: 3 g strength: approx. 3 kg</p>	<p>Price in CHF</p> <p>5 pcs. 1.31 ea. from 15 pcs. 1.13 ea. from 40 pcs. 1.00 ea. from 80 pcs. 0.91 ea.</p>	<p>Diameter D: 13 mm Total height H: 4.5 mm Hole d1: 3 mm Hole d2: 5.5 mm Countersinking t: 1.25 mm Tolerance: +/- 0.1 mm</p>
<p><b>CSN-16</b> Pot magnet Ø 16 mm with countersunk hole, holds approx. 4 kg Weight: 5 g strength: approx. 4 kg</p>	<p>Price in CHF</p> <p>5 pcs. 1.59 ea. from 15 pcs. 1.39 ea. from 40 pcs. 1.23 ea. from 80 pcs. 1.14 ea.</p>	<p>Diameter D: 16 mm Total height H: 4.5 mm Hole d1: 3.5 mm Hole d2: 7.22 mm Countersinking t: 1.86 mm Tolerance: +/- 0.1 mm</p>
<p><b>CSN-ES-16</b> Pot magnet Ø 16 mm with countersunk hole, holds approx. 6.9 kg Weight: 5.5 g strength: approx. 6.9 kg</p>	<p>Price in CHF</p> <p>5 pcs. 1.55 ea. from 15 pcs. 1.35 ea. from 40 pcs. 1.20 ea. from 80 pcs. 1.11 ea.</p>	<p>Similar dimensions as CSN-16, but with a thicker steel pot. Hence higher adhesive force than CSN-16.</p>
<p><b>CSN-HT-16</b> Pot magnet Ø 16 mm with countersunk hole, holds approx. 4 kg Weight: 5 g strength: approx. 4 kg</p>	<p>Price in CHF</p> <p>1 pc. 2.50 ea. from 3 pcs. 2.20 ea. from 10 pcs. 1.90 ea. from 20 pcs. 1.75 ea. from 40 pcs. 1.65 ea.</p>	<p>This magnet in a steel pot has a countersunk hole and can be fastened with a countersunk screw. Its design is identical to CSN-16, but this magnet is heat-resistant up to 150°C.</p>
<p><b>CSN-20</b> Pot magnet Ø 20 mm with countersunk hole, holds approx. 8.9 kg Weight: 11 g strength: approx. 8.9 kg</p>	<p>Price in CHF</p> <p>1 pc. 2.60 ea. from 3 pcs. 2.25 ea. from 10 pcs. 1.95 ea. from 20 pcs. 1.80 ea. from 40 pcs. 1.70 ea.</p>	<p>Diameter D: 20 mm Total height H: 6 mm Hole d1: 4.5 mm Hole d2: 9.46 mm Countersinking t: 2.48 mm Tolerance: +/- 0.1 mm</p>

<p><b>CSN-ES-20</b> Pot magnet Ø 20 mm with countersunk hole, holds approx. 11 kg Weight: 12 g strength: approx. 11 kg</p>	<p>Price in CHF</p> <p>1 pc. 2.65 ea. from 3 pcs. 2.30 ea. from 10 pcs. 2.00 ea. from 20 pcs. 1.85 ea. from 40 pcs. 1.70 ea.</p>	<p>Similar dimensions as CSN-20, but with a thicker steel pot. Hence higher adhesive force than CSN-20.</p>
<p><b>CSN-HT-20</b> Pot magnet Ø 20 mm with countersunk hole, holds approx. 8.9 kg Weight: 11 g strength: approx. 8.9 kg</p>	<p>Price in CHF</p> <p>1 pc. 2.90 ea. from 3 pcs. 2.50 ea. from 10 pcs. 2.20 ea. from 20 pcs. 2.05 ea. from 40 pcs. 1.90 ea.</p>	<p>This magnet in a steel pot has a countersunk hole and can be fastened with a countersunk screw. Its design is identical to CSN-20, but this magnet is heat-resistant up to 150°C.</p>
<p><b>CSN-25</b> Pot magnet Ø 25 mm with countersunk hole, holds approx. 19 kg Weight: 20 g strength: approx. 19 kg</p>	<p>Price in CHF</p> <p>1 pc. 3.65 ea. from 3 pcs. 3.20 ea. from 10 pcs. 2.80 ea. from 20 pcs. 2.60 ea. from 40 pcs. 2.45 ea.</p>	<p>Diameter D: 25 mm Total height H: 7 mm Hole d1: 5.5 mm Hole d2: 11.7 mm Countersinking t: 3.1 mm Tolerance: +/- 0.1 mm</p>
<p><b>CSN-HT-25</b> Pot magnet Ø 25 mm with countersunk hole, holds approx. 19 kg Weight: 20 g strength: approx. 19 kg</p>	<p>Price in CHF</p> <p>1 pc. 4.35 ea. from 3 pcs. 3.80 ea. from 10 pcs. 3.35 ea. from 20 pcs. 3.15 ea. from 40 pcs. 2.95 ea.</p>	<p>This magnet in a steel pot has a countersunk hole and can be fastened with a countersunk screw. Its design is identical to CSN-25, but this magnet is heat-resistant up to 150°C.</p>
<p><b>CSN-32</b> Pot magnet Ø 32 mm with countersunk hole, holds approx. 30 kg Weight: 35 g strength: approx. 30 kg</p>	<p>Price in CHF</p> <p>1 pc. 5.60 ea. from 3 pcs. 5.00 ea. from 10 pcs. 4.45 ea. from 20 pcs. 4.20 ea. from 40 pcs. 3.95 ea.</p>	<p>Diameter D: 32 mm Total height H: 7 mm Hole d1: 5.5 mm Hole d2: 11.7 mm Countersinking t: 3.1 mm Tolerance: +/- 0.1 mm</p>
<p><b>CSN-HT-32</b> Pot magnet Ø 32 mm with countersunk hole, holds approx. 30 kg Weight: 35 g strength: approx. 30 kg</p>	<p>Price in CHF</p> <p>1 pc. 6.80 ea. from 3 pcs. 6.10 ea. from 10 pcs. 5.45 ea. from 20 pcs. 5.15 ea. from 40 pcs. 4.90 ea.</p>	<p>This magnet in a steel pot has a countersunk hole and can be fastened with a countersunk screw. Its design is identical to CSN-32, but this magnet is heat-resistant up to 150°C.</p>
<p><b>CSN-40</b> Pot magnet Ø 40 mm with countersunk hole, holds approx. 52 kg Weight: 65 g strength: approx. 52 kg</p>	<p>Price in CHF</p> <p>1 pc. 8.15 ea. from 3 pcs. 7.30 ea. from 10 pcs. 6.55 ea. from 20 pcs. 6.20 ea. from 40 pcs. 5.85 ea.</p>	<p>Diameter D: 40 mm Total height H: 8 mm Hole d1: 5.5 mm Hole d2: 11.7 mm Countersinking t: 3.1 mm Tolerance: +/- 0.1 mm</p>
<p><b>CSN-48</b> Pot magnet Ø 48 mm with countersunk hole, holds approx. 87 kg Weight: 120 g strength: approx. 87 kg</p>	<p>Price in CHF</p> <p>1 pc. 11.60 ea. from 3 pcs. 10.40 ea. from 10 pcs. 9.40 ea. from 20 pcs. 8.90 ea. from 40 pcs. 8.45 ea.</p>	<p>Diameter D: 48 mm Total height H: 11.5 mm Hole d1: 8.5 mm Hole d2: 18.12 mm Countersinking t: 4.81 mm Tolerance: +/- 0.1 mm</p>
<p><b>CSN-60</b> Pot magnet Ø 60 mm with countersunk hole, holds approx. 130 kg Weight: 250 g strength: approx. 130 kg</p>	<p>Price in CHF</p> <p>1 pc. 19.80 ea. from 3 pcs. 17.95 ea. from 10 pcs. 16.25 ea. from 20 pcs. 15.45 ea. from 40 pcs. 14.75 ea.</p>	<p>Diameter D: 60 mm Total height H: 15 mm Hole d1: 8.5 mm Hole d2: 18.12 mm Countersinking t: 4.81 mm Tolerance: +/- 0.1 mm</p>

## Hook magnets neodymium: strong & practical

Distinctive feature: These magnets can be used to hang up objects. The hook can be unscrewed. You have the choice of silver, white, black and green colour.

Principle: The magnets are embedded in a steel pot. The steel pot increases the adhesive force of the magnet on direct contact with a thick iron surface. If there is no direct contact with the counterpart, or if the steel plate is thin, painted or rough, you can strain it much less.

Shear force: The indicated adhesive force was measured perpendicular to the surface to which the magnet should stick. It takes a lot less strength to move the magnet sideways. Therefore, you can put a lot less strain on a pot magnet when you use it on a wall as opposed to using it on the ceiling.

Rust: These magnets are not rust-free and therefore intended for dry indoor use.

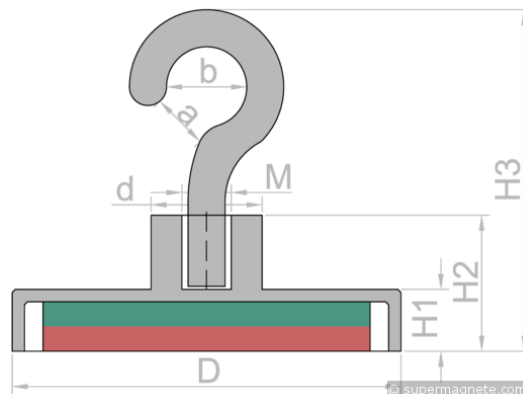

<b>FTN-10</b> Hook magnet Ø 10 mm, holds approx. 3 kg Thread M3 Weight: 5 g strength: approx. 3 kg	Price in CHF 5 pcs. 1.44 ea. from 15 pcs. 1.25 ea. from 40 pcs. 1.11 ea. from 80 pcs. 1.03 ea.	Pot diameter D: 10 mm Neck diameter d: 5 mm Pot height H1: 4.5 mm Total height without hook H2: 11.5 mm with hook H3: 26 mm
<b>FTN-13</b> Hook magnet Ø 13 mm, holds approx. 5 kg Thread M3 Weight: 6.5 g strength: approx. 5 kg	Price in CHF 5 pcs. 1.60 ea. from 15 pcs. 1.39 ea. from 40 pcs. 1.24 ea. from 80 pcs. 1.15 ea.	Pot diameter D: 13 mm Neck diameter d: 5 mm Pot height H1: 4.5 mm Total height without hook H2: 11.5 mm with hook H3: 26 mm
<b>FTN-16</b> Hook magnet Ø 16 mm, holds approx. 8 kg Thread M4 Weight: 11 g strength: approx. 8 kg	Price in CHF 5 pcs. 1.77 ea. from 15 pcs. 1.54 ea. from 40 pcs. 1.38 ea. from 80 pcs. 1.28 ea.	Pot diameter D: 16 mm Neck diameter d: 6 mm Pot height H1: 4.5 mm Total height without hook H2: 11.5 mm with hook H3: 27 mm
<b>FTNW-16</b> Hook magnet white Ø 16.3 mm powder-coated thread M4 Weight: 11 g strength: approx. 6 kg	Price in CHF 1 pc. 2.15 ea. from 3 pcs. 1.90 ea. from 10 pcs. 1.65 ea. from 20 pcs. 1.55 ea. from 40 pcs. 1.40 ea.	Pot diameter D: 16.3 mm Neck diameter d: 6.3 mm Pot height H1: 4.8 mm Total height without hook H2: 11.8 mm Total height with hook H3: 27.3 mm Thread M: 4
<b>FTNB-16</b> Hook magnet black Ø 16.3 mm powder-coated thread M4 Weight: 11 g strength: approx. 6 kg	Price in CHF 1 pc. 2.15 ea. from 3 pcs. 1.90 ea. from 10 pcs. 1.65 ea. from 20 pcs. 1.55 ea. from 40 pcs. 1.40 ea.	Pot diameter D: 16.3 mm Neck diameter d: 6.3 mm Pot height H1: 4.8 mm Total height without hook H2: 11.8 mm Total height with hook H3: 27.3 mm Thread M: 4
<b>FTNG-16</b> Hook magnet green Ø 16.3 mm powder-coated thread M4 Weight: 11 g strength: approx. 6 kg	Price in CHF 1 pc. 2.15 ea. from 3 pcs. 1.90 ea. from 10 pcs. 1.65 ea. from 20 pcs. 1.55 ea. from 40 pcs. 1.45 ea.	Pot diameter D: 16.3 mm Neck diameter d: 6.3 mm Pot height H1: 4.8 mm Total height without hook H2: 11.8 mm Total height with hook H3: 27.3 mm Thread M: 4



<b>FTN-20</b> Hook magnet Ø 20 mm, holds approx. 13 kg Thread M4 Weight: 20 g strength: approx. 13 kg	Price in CHF 1 pc. 2.70 ea. from 3 pcs. 2.35 ea. from 10 pcs. 2.05 ea. from 20 pcs. 1.85 ea. from 40 pcs. 1.75 ea.	Pot diameter D: 20 mm Neck diameter d: 8 mm Pot height H1: 6 mm Total height without hook H2: 13 mm with hook H3: 29 mm
<b>FTNB-20</b> Hook magnet black Ø 20.3 mm powder-coated thread M4 Weight: 20 g strength: approx. 13 kg	Price in CHF 1 pc. 3.25 ea. from 3 pcs. 2.90 ea. from 10 pcs. 2.55 ea. from 20 pcs. 2.40 ea. from 40 pcs. 2.25 ea.	Pot diameter D: 20.3 mm Neck diameter d: 8.3 mm Pot height H1: 6.3 mm Total height without hook H2: 13.3 mm Total height with hook H3: 29.3 mm Thread M: 4
<b>FTNG-20</b> Hook magnet green Ø 20.3 mm powder-coated thread M4 Weight: 20 g strength: approx. 13 kg	Price in CHF 1 pc. 3.25 ea. from 3 pcs. 2.90 ea. from 10 pcs. 2.55 ea. from 20 pcs. 2.40 ea. from 40 pcs. 2.25 ea.	Pot diameter D: 20.3 mm Neck diameter d: 8.3 mm Pot height H1: 6.3 mm Total height without hook H2: 13.3 mm Total height with hook H3: 29.3 mm Thread M: 4
<b>FTN-25</b> Hook magnet Ø 25 mm, holds approx. 18 kg Thread M4 Weight: 30 g strength: approx. 18 kg	Price in CHF 1 pc. 3.15 ea. from 3 pcs. 2.75 ea. from 10 pcs. 2.40 ea. from 20 pcs. 2.20 ea. from 40 pcs. 2.05 ea.	Pot diameter D: 25 mm Neck diameter d: 8 mm Pot height H1: 7 mm Total height without hook H2: 14 mm with hook H3: 30 mm
<b>FTNW-25</b> Hook magnet white Ø 25.3 mm powder-coated thread M4 Weight: 29 g strength: approx. 16 kg	Price in CHF 1 pc. 3.50 ea. from 3 pcs. 3.10 ea. from 10 pcs. 2.75 ea. from 20 pcs. 2.60 ea. from 40 pcs. 2.45 ea.	Pot diameter D: 25.3 mm Neck diameter d: 8.3 mm Pot height H1: 7.3 mm Total height without hook H2: 14.3 mm Total height with hook H3: 30.3 mm Thread M: 4
<b>FTNB-25</b> Hook magnet black Ø 25.3 mm powder-coated thread M4 Weight: 29 g strength: approx. 16 kg	Price in CHF 1 pc. 3.50 ea. from 3 pcs. 3.10 ea. from 10 pcs. 2.75 ea. from 20 pcs. 2.60 ea. from 40 pcs. 2.45 ea.	Pot diameter D: 25.3 mm Neck diameter d: 8.3 mm Pot height H1: 7.3 mm Total height without hook H2: 14.3 mm Total height with hook H3: 30.3 mm Thread M: 4
<b>FTNG-25</b> Hook magnet green Ø 25.3 mm powder-coated thread M4 Weight: 29 g strength: approx. 16 kg	Price in CHF 1 pc. 3.50 ea. from 3 pcs. 3.10 ea. from 10 pcs. 2.75 ea. from 20 pcs. 2.60 ea. from 40 pcs. 2.45 ea.	Pot diameter D: 25.3 mm Neck diameter d: 8.3 mm Pot height H1: 7.3 mm Total height without hook H2: 14.3 mm Total height with hook H3: 30.3 mm Thread M: 4
<b>FTNT-25</b> Pot magnet with rotating hook Ø 25 mm strength approx. 20 kg Weight: 37 g strength: approx. 20 kg	Price in CHF 1 pc. 4.20 ea. from 3 pcs. 3.70 ea. from 10 pcs. 3.25 ea. from 20 pcs. 3.05 ea. from 40 pcs. 2.85 ea.	This magnet hook is guaranteed to always point in the desired direction, as the hook is designed to turn freely around the magnet base. Height of the magnet pot: 15 mm. Maximum extension with positioned hook: approx. 63 mm.
<b>FTN-32</b> Hook magnet Ø 32 mm, holds approx. 30 kg Thread M5 Weight: 52 g strength: approx. 30 kg	Price in CHF 1 pc. 4.25 ea. from 3 pcs. 3.75 ea. from 10 pcs. 3.30 ea. from 20 pcs. 3.05 ea. from 40 pcs. 2.85 ea.	Pot diameter D: 32 mm Neck diameter d: 10 mm Pot height H1: 7 mm Total height without hook H2: 15.5 mm with hook H3: 45 mm

<p><b>FTNW-32</b> Hook magnet white Ø 32.3 mm powder-coated thread M5 Weight: 53 g strength: approx. 28 kg</p>	<p>Price in CHF</p> <p>1 pc. 5.25 ea. from 3 pcs. 4.65 ea. from 10 pcs. 4.15 ea. from 20 pcs. 3.85 ea. from 40 pcs. 3.65 ea.</p>	<p>Pot diameter D: 32.3 mm Neck diameter d: 10.3 mm Pot height H1: 7.3 mm Total height without hook H2: 15.8 mm Total height with hook H3: 45.3 mm Thread M: 5</p>
<p><b>FTNB-32</b> Hook magnet black Ø 32.3 mm powder-coated thread M5 Weight: 53 g strength: approx. 28 kg</p>	<p>Price in CHF</p> <p>1 pc. 5.25 ea. from 3 pcs. 4.65 ea. from 10 pcs. 4.15 ea. from 20 pcs. 3.85 ea. from 40 pcs. 3.65 ea.</p>	<p>Pot diameter D: 32.3 mm Neck diameter d: 10.3 mm Pot height H1: 7.3 mm Total height without hook H2: 15.8 mm Total height with hook H3: 45.3 mm Thread M: 5</p>
<p><b>FTNG-32</b> Hook magnet green Ø 32.3 mm powder-coated thread M5 Weight: 53 g strength: approx. 28 kg</p>	<p>Price in CHF</p> <p>1 pc. 5.25 ea. from 3 pcs. 4.65 ea. from 10 pcs. 4.15 ea. from 20 pcs. 3.85 ea. from 40 pcs. 3.65 ea.</p>	<p>Pot diameter D: 32.3 mm Neck diameter d: 10.3 mm Pot height H1: 7.3 mm Total height without hook H2: 15.8 mm Total height with hook H3: 45.3 mm Thread M: 5</p>
<p><b>KTN-25</b> Pot magnet Ø 25 mm with carabiner length of carabiner 60 mm Weight: 38 g strength: approx. 25 kg</p>	<p>Price in CHF</p> <p>1 pc. 4.95 ea. from 3 pcs. 4.45 ea. from 10 pcs. 4.00 ea. from 20 pcs. 3.75 ea. from 40 pcs. 3.55 ea.</p>	<p>This pot magnet with carabiner guarantees a secure hold of the mounted objects, even when they are pulled sideways. Therefore, it can be used wherever you would use eyelet or hook magnets otherwise, e.g. at home or in the workshop.</p>
<p><b>KTN-25B</b> Pot magnet Ø 25 mm with blue carabiner length of carabiner 60 mm Weight: 38 g strength: approx. 25 kg</p>	<p>Price in CHF</p> <p>1 pc. 4.60 ea. from 3 pcs. 4.10 ea. from 10 pcs. 3.65 ea. from 20 pcs. 3.40 ea. from 40 pcs. 3.25 ea.</p>	<p>Pot diameter D: 25 mm Pot height H1: 8 mm Total height without carabiner H2: 18.5 mm Length of carabiner h1: 60 mm Max. weight on carabiner: 15 kg Tolerance: +/- 0.1 mm</p>
<p><b>KTN-25P</b> Pot magnet Ø 25 mm with pink carabiner length of carabiner 60 mm Weight: 38 g strength: approx. 25 kg</p>	<p>Price in CHF</p> <p>1 pc. 4.60 ea. from 3 pcs. 4.10 ea. from 10 pcs. 3.65 ea. from 20 pcs. 3.40 ea. from 40 pcs. 3.25 ea.</p>	<p>Pot diameter D: 25 mm Pot height H1: 8 mm Total height without carabiner H2: 18.5 mm Length of carabiner h1: 60 mm Max. weight on carabiner: 15 kg Tolerance: +/- 0.1 mm</p>
<p><b>KTN-32</b> Pot magnet Ø 32 mm with carabiner length of carabiner 60 mm Weight: 55 g strength: approx. 39 kg</p>	<p>Price in CHF</p> <p>1 pc. 5.20 ea. from 3 pcs. 4.70 ea. from 10 pcs. 4.30 ea. from 20 pcs. 4.10 ea. from 40 pcs. 3.90 ea.</p>	<p>This pot magnet with carabiner guarantees a secure hold of the mounted objects, even when they are pulled sideways. Therefore, it can be used wherever you would use eyelet or hook magnets otherwise, e.g. at home or in the workshop.</p>
<p><b>KTN-32B</b> Pot magnet Ø 32 mm with blue carabiner length of carabiner 60 mm Weight: 55 g strength: approx. 39 kg</p>	<p>Price in CHF</p> <p>1 pc. 5.40 ea. from 3 pcs. 4.85 ea. from 10 pcs. 4.40 ea. from 20 pcs. 4.20 ea. from 40 pcs. 4.00 ea.</p>	<p>Pot diameter D: 32 mm Pot height H1: 8 mm Total height without carabiner H2: 18.5 mm Length of carabiner h1: 60 mm Max. weight on carabiner: 15 kg Tolerance: +/- 0.1 mm</p>
<p><b>KTN-32P</b> Pot magnet Ø 32 mm with pink carabiner length of carabiner 60 mm Weight: 55 g strength: approx. 39 kg</p>	<p>Price in CHF</p> <p>1 pc. 5.40 ea. from 3 pcs. 4.85 ea. from 10 pcs. 4.40 ea. from 20 pcs. 4.20 ea. from 40 pcs. 4.00 ea.</p>	<p>Pot diameter D: 32 mm Pot height H1: 8 mm Total height without carabiner H2: 18.5 mm Length of carabiner h1: 60 mm Max. weight on carabiner: 15 kg Magnetisation: N42</p>

<p><b>FTNT-40-B</b> Pot magnet with rotating hook Ø 40.2 mm black, with rubberised surface Weight: 87 g strength: approx. 22 kg</p>	<p>Price in CHF</p> <p>1 pc. 8.50 ea. from 3 pcs. 7.55 ea. from 10 pcs. 6.70 ea. from 20 pcs. 6.30 ea. from 40 pcs. 5.95 ea.</p>	<p>Hook opening width a: 18 mm Pot height H: 18 mm Pot diameter D: 40.2 mm Thickness rubber: 0.5 mm Tolerance: +/- 0.1 mm Coating: Nickel (ni), powder-coated black</p>
<p><b>FTN-40</b> Hook magnet Ø 40 mm, holds approx. 55 kg Thread M6 Weight: 120 g strength: approx. 55 kg</p>	<p>Price in CHF</p> <p>1 pc. 7.65 ea. from 3 pcs. 6.80 ea. from 10 pcs. 6.05 ea. from 20 pcs. 5.70 ea. from 40 pcs. 5.40 ea.</p>	<p>Pot diameter D: 40 mm Neck diameter d: 15 mm Pot height H1: 9 mm Total height without hook H2: 18 mm with hook H3: 59 mm</p>
<p><b>FTNW-40</b> Hook magnet white Ø 40.3 mm powder-coated thread M6 Weight: 110 g strength: approx. 50 kg</p>	<p>Price in CHF</p> <p>1 pc. 8.50 ea. from 3 pcs. 7.60 ea. from 10 pcs. 6.80 ea. from 20 pcs. 6.40 ea. from 40 pcs. 6.05 ea.</p>	<p>Pot diameter D: 40.3 mm Neck diameter d: 15.3 mm Pot height H1: 9.3 mm Total height without hook H2: 18.3 mm Total height with hook H3: 59.3 mm Thread M: 6</p>
<p><b>FTN-50</b> Hook magnet Ø 50 mm, holds approx. 75 kg Thread M8 Weight: 170 g strength: approx. 75 kg</p>	<p>Price in CHF</p> <p>1 pc. 10.50 ea. from 3 pcs. 9.40 ea. from 10 pcs. 8.40 ea. from 20 pcs. 7.95 ea. from 40 pcs. 7.50 ea.</p>	<p>Pot diameter D: 50 mm Neck diameter d: 15 mm Pot height H1: 9 mm Total height without hook H2: 18 mm with hook H3: 62 mm</p>
<p><b>FTN-63</b> Hook magnet Ø 63 mm, holds approx. 110 kg Thread M8 Weight: 270 g strength: approx. 110 kg</p>	<p>Price in CHF</p> <p>1 pc. 16.65 ea. from 3 pcs. 15.00 ea. from 10 pcs. 13.55 ea. from 20 pcs. 12.85 ea. from 40 pcs. 12.20 ea.</p>	<p>Pot diameter D: 63 mm Neck diameter d: 18 mm Pot height H1: 10 mm Total height without hook H2: 22 mm with hook H3: 66 mm</p>
<p><b>FTN-75</b> Hook magnet Ø 75 mm, holds approx. 130 kg Thread M10 Weight: 410 g strength: approx. 130 kg</p>	<p>Price in CHF</p> <p>1 pc. 25.45 ea. from 3 pcs. 23.35 ea. from 10 pcs. 21.45 ea. from 20 pcs. 20.55 ea. from 40 pcs. 19.70 ea.</p>	<p>Pot diameter D: 75 mm Neck diameter d: 20 mm Pot height H1: 11 mm Total height without hook H2: 25 mm with hook H3: 70 mm</p>

## Pot magnets with threaded stud

Distinctive feature: These magnets have an external thread.

Principle: The magnets are embedded in a steel pot. The steel pot increases the adhesive force of the magnet on direct contact with a thick iron surface. If there is no direct contact with the counterpart, or if the steel plate is thin, painted or rough, you won't be able to put as much strain on it.

Shear force: The indicated adhesive force was measured perpendicular to the surface to which the magnet should stick. It takes a lot less strength to move the magnet sideways. Therefore, you won't be able to put as much strain on a pot magnet if you use it on a wall as opposed to using it on the ceiling.

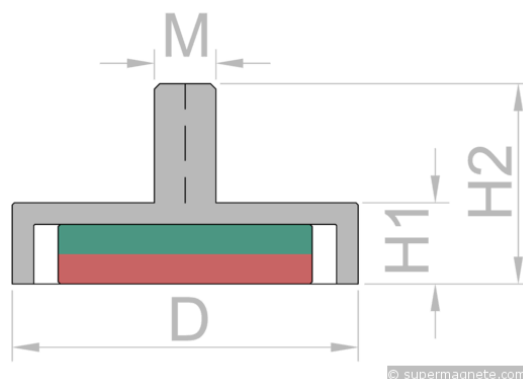

Rust: These magnets are not rust-free and therefore intended for dry indoor use.

<p><b>GTN-10</b> Pot magnet Ø 10 mm with threaded stud, holds approx. 2.5 kg Thread M3 Weight: 3.5 g strength: approx. 2.5 kg</p>	<p>Price in CHF</p> <p>5 pcs. 1.42 ea. from 15 pcs. 1.22 ea. from 40 pcs. 1.08 ea. from 80 pcs. 0.99 ea.</p>	<p>Pot diameter D: 10 mm Pot height H1: 5 mm Total height H2: 12 mm Tolerance: +/- 0.1 mm Coating: Nickel-plated (Ni-Cu-Ni) Max. working temperature: 80°C</p>
<p><b>GTN-13</b> Pot magnet Ø 13 mm with threaded stud, holds approx. 3.5 kg Thread M3 Weight: 4 g strength: approx. 3.5 kg</p>	<p>Price in CHF</p> <p>5 pcs. 1.53 ea. from 15 pcs. 1.33 ea. from 40 pcs. 1.18 ea. from 80 pcs. 1.09 ea.</p>	<p>Pot diameter D: 13 mm Pot height H1: 5 mm Total height H2: 12 mm Tolerance: +/- 0.1 mm Coating: Nickel-plated (Ni-Cu-Ni) Max. working temperature: 80°C</p>
<p><b>SALE-130</b> Pot magnet Ø 16 mm with threaded stud, holds approx. 8 kg Thread M4 Weight: 7.6 g strength: approx. 8 kg</p>	<p>Price in CHF</p> <p>5 pcs. 1.56 ea. from 15 pcs. 1.35 ea. from 40 pcs. 1.19 ea. from 80 pcs. 1.09 ea.</p>	<p>Pot diameter D: 16 mm Pot height H1: 5 mm Total height H2: 9 mm Tolerance: +/- 0.1 mm Coating: Nickel-plated (Ni-Cu-Ni) Max. working temperature: 80°C</p>
<p><b>GTN-16</b> Pot magnet Ø 16 mm with threaded stud, holds approx. 8 kg Thread M4 Weight: 7.3 g strength: approx. 8 kg</p>	<p>Price in CHF</p> <p>5 pcs. 1.64 ea. from 15 pcs. 1.43 ea. from 40 pcs. 1.27 ea. from 80 pcs. 1.17 ea.</p>	<p>Pot diameter D: 16 mm Pot height H1: 5 mm Total height H2: 13.5 mm Tolerance: +/- 0.1 mm Coating: Nickel-plated (Ni-Cu-Ni) Max. working temperature: 80°C</p>
<p><b>GTN-20</b> Pot magnet Ø 20 mm with threaded stud, holds approx. 12 kg Thread M4 Weight: 15 g strength: approx. 12 kg</p>	<p>Price in CHF</p> <p>1 pc. 2.75 ea. from 3 pcs. 2.40 ea. from 10 pcs. 2.10 ea. from 20 pcs. 1.95 ea. from 40 pcs. 1.80 ea.</p>	<p>Pot diameter D: 20 mm Pot height H1: 7 mm Total height H2: 15.5 mm Tolerance: +/- 0.1 mm Coating: Nickel-plated (Ni-Cu-Ni) Max. working temperature: 80°C</p>
<p><b>GTN-25</b> Pot magnet Ø 25 mm with threaded stud, holds approx. 25 kg Thread M5 Weight: 27 g strength: approx. 25 kg</p>	<p>Price in CHF</p> <p>1 pc. 3.35 ea. from 3 pcs. 2.95 ea. from 10 pcs. 2.55 ea. from 20 pcs. 2.40 ea. from 40 pcs. 2.20 ea.</p>	<p>Pot diameter D: 25 mm Pot height H1: 8 mm Total height H2: 16.5 mm Tolerance: +/- 0.1 mm Coating: Nickel-plated (Ni-Cu-Ni) Max. working temperature: 80°C</p>

<b>GTN-32</b>		Price in CHF	Pot diameter D: 32 mm
Pot magnet Ø 32 mm with threaded stud, holds approx. 39 kg	from	1 pc. 4.60 ea.	Pot height H1: 8 mm
Thread M6	from	3 pcs. 4.05 ea.	Total height H2: 18.5 mm
Weight: 44 g	from	10 pcs. 3.55 ea.	Tolerance: +/- 0.1 mm
strength: approx. 39 kg	from	20 pcs. 3.30 ea.	Coating: Nickel-plated (Ni-Cu-Ni)
	from	40 pcs. 3.10 ea.	Max. working temperature: 80°C
<b>GTN-40</b>		Price in CHF	Pot diameter D: 40 mm
Pot magnet Ø 40 mm with threaded stud, holds approx. 45 kg	from	1 pc. 6.95 ea.	Pot height H1: 9 mm
Thread M8	from	3 pcs. 6.20 ea.	Total height H2: 20 mm
Weight: 80 g	from	10 pcs. 5.55 ea.	Tolerance: +/- 0.1 mm
strength: approx. 45 kg	from	20 pcs. 5.20 ea.	Coating: Nickel-plated (Ni-Cu-Ni)
	from	40 pcs. 4.95 ea.	Max. working temperature: 80°C
<b>GTN-48</b>		Price in CHF	Pot diameter D: 48 mm
Pot magnet Ø 48 mm with threaded stud, holds approx. 85 kg	from	1 pc. 12.30 ea.	Pot height H1: 11.5 mm
Thread M8	from	3 pcs. 11.05 ea.	Total height H2: 24 mm
Weight: 140 g	from	10 pcs. 10.00 ea.	Tolerance: +/- 0.1 mm
strength: approx. 85 kg	from	20 pcs. 9.45 ea.	Coating: Nickel-plated (Ni-Cu-Ni)
	from	40 pcs. 9.00 ea.	Max. working temperature: 80°C
<b>GTN-60</b>		Price in CHF	Pot diameter D: 60 mm
Pot magnet Ø 60 mm with threaded stud, holds approx. 130 kg	from	1 pc. 20.70 ea.	Pot height H1: 15 mm
Thread M8	from	3 pcs. 18.80 ea.	Total height H2: 30 mm
Weight: 260 g	from	10 pcs. 17.10 ea.	Tolerance: +/- 0.1 mm
strength: approx. 130 kg	from	20 pcs. 16.25 ea.	Coating: Nickel-plated (Ni-Cu-Ni)
	from	40 pcs. 15.50 ea.	Max. working temperature: 80°C

## Channel magnets

Channel magnets are rectangular or square pot magnets that can be fastened with a countersunk head screw. They consist of a U-shaped steel profile into which a neodymium block magnet is embedded. This design strengthens the holding power of the magnet enormously at direct contact with a counterpart. Additionally, the steel coating protects the fragile magnet from damages caused by repeated blows.

<b>CSR-100-20-05-N</b> channel magnet 100 x 20 x 5 mm with countersunk hole in U-shaped steel profile Weight: 64 g strength: approx. 62 kg	Price in CHF 1 pc. 10.25 ea. from 3 pcs. 9.05 ea. from 10 pcs. 7.95 ea. from 20 pcs. 7.40 ea. from 40 pcs. 6.95 ea.	Length S1: 100 mm Length S2: 20 mm Height H: 5 mm Hole d1: 4.5 mm Countersink d2: 9.46 mm Countersink t: 2.48 mm
<b>CSR-120-20-05-N</b> Channel magnet 120 x 20 x 5 mm with countersunk hole in U-shaped steel profile Weight: 77 g strength: approx. 79 kg	Price in CHF 1 pc. 12.15 ea. from 3 pcs. 10.75 ea. from 10 pcs. 9.45 ea. from 20 pcs. 8.80 ea. from 40 pcs. 8.25 ea.	Length S1: 120 mm Length S2: 20 mm Height H: 5 mm Hole d1: 4.5 mm Countersink d2: 9.46 mm Countersink t: 2.48 mm
<b>CSR-15-15-04-N</b> Channel magnet 15 x 15 x 4 mm with countersunk hole in U-shaped steel profile Weight: 5.5 g strength: approx. 5.5 kg	Price in CHF 1 pc. 2.30 ea. from 3 pcs. 2.00 ea. from 10 pcs. 1.75 ea. from 20 pcs. 1.65 ea. from 40 pcs. 1.50 ea.	Length S1: 15 mm Length S2: 15 mm Height H: 4 mm Hole d1: 4.5 mm Countersink d2: 9.46 mm Countersink t: 3 mm
<b>CSR-20-20-04-N</b> Channel magnet 20 x 20 x 4 mm with countersunk hole in U-shaped steel profile Weight: 11 g strength: approx. 10 kg	Price in CHF 1 pc. 2.75 ea. from 3 pcs. 2.40 ea. from 10 pcs. 2.10 ea. from 20 pcs. 1.95 ea. from 40 pcs. 1.85 ea.	Length S1: 20 mm Length S2: 20 mm Height H: 4 mm Hole d1: 4.5 mm Countersink d2: 9.46 mm Countersink t: 3 mm
<b>CSR-25-13-04-N</b> Channel magnet 25 x 13 x 4 mm with countersunk hole in U-shaped steel profile Weight: 8 g strength: approx. 10 kg	Price in CHF 1 pc. 2.50 ea. from 3 pcs. 2.20 ea. from 10 pcs. 1.95 ea. from 20 pcs. 1.85 ea. from 40 pcs. 1.75 ea.	Length S1: 25 mm Length S2: 13 mm Height H: 4 mm Hole d1: 4.5 mm Countersink d2: 9.46 mm Countersink t: 2.48 mm
<b>CSR-40-20-04-N</b> Channel magnet 40 x 20 x 4 mm with two countersunk holes in U-shaped steel profile Weight: 21 g strength: approx. 17 kg	Price in CHF 1 pc. 4.20 ea. from 3 pcs. 3.70 ea. from 10 pcs. 3.25 ea. from 20 pcs. 3.00 ea. from 40 pcs. 2.85 ea.	Length S1: 40 mm Length S2: 20 mm Height H: 4 mm Hole d1: 4.5 mm Countersink d2: 9.46 mm Countersink t: 3 mm
<b>CSR-40-40-04-N</b> Channel magnet 40 x 40 x 4 mm with two countersunk holes in U-shaped steel profile Weight: 44 g strength: approx. 25 kg	Price in CHF 1 pc. 6.80 ea. from 3 pcs. 6.05 ea. from 10 pcs. 5.40 ea. from 20 pcs. 5.10 ea. from 40 pcs. 4.80 ea.	Length S1: 40 mm Length S2: 40 mm Height H: 4 mm Hole d1: 4.5 mm Countersink d2: 9.46 mm Countersink t: 2.48 mm
<b>CSR-60-20-04-N</b> Channel magnet 60 x 20 x 4 mm with two countersunk holes in U-shaped steel profile Weight: 33 g strength: approx. 29 kg	Price in CHF 1 pc. 6.20 ea. from 3 pcs. 5.55 ea. from 10 pcs. 4.95 ea. from 20 pcs. 4.70 ea. from 40 pcs. 4.40 ea.	Length S1: 60 mm Length S2: 20 mm Height H: 4 mm Hole d1: 4.5 mm Countersink d2: 9.46 mm Countersink t: 3 mm

**CSR-80-20-04-N**

Channel magnet 80 x 20 x  
4 mm  
with two countersunk holes  
in U-shaped steel profile  
Weight: 44 g  
strength: approx. 37 kg

Price in CHF

	1 pc.	7.40 ea.
from	3 pcs.	6.60 ea.
from	10 pcs.	5.95 ea.
from	20 pcs.	5.60 ea.
from	40 pcs.	5.30 ea.

Length S1: 80 mm  
Length S2: 20 mm  
Height H: 4 mm  
Hole d1: 4.5 mm  
Countersink d2: 9.46 mm  
Countersink t: 3 mm

## Eyelet magnets neodymium

Distinctive feature: These magnets are suitable for securely hanging up objects. The eyelet can be removed. You can choose between silver-coloured and white eyelet magnets. The latter are barely noticeable on white walls and ceilings. The silver eyelet magnets are slightly cheaper and stronger.

Principle: The magnets are embedded in a steel pot. The steel pot increases the adhesive force of the magnet on direct contact with a thick iron surface. If there is no direct contact with the counterpart, or if the steel plate is thin, painted or rough, you won't be able to put as much strain on it.

Shear force: The indicated adhesive force was measured perpendicular to the surface to which the magnet should stick. It takes a lot less strength to move the magnet sideways. Therefore, you won't be able to put as much strain on a pot magnet if you use it on a wall as opposed to using it on the ceiling.

Rust: These magnets are not rust-proof and therefore intended for dry indoor use.

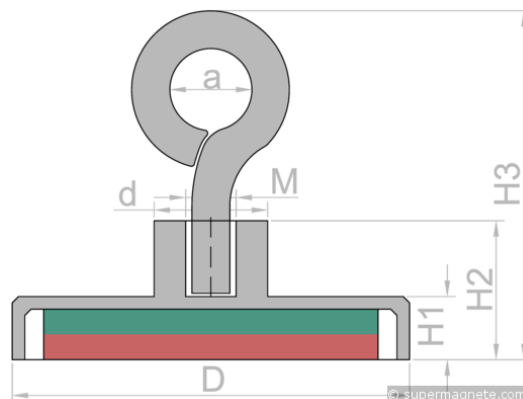

<b>OTN-16</b> Pot magnet Ø 16 mm with eyelet thread M4 Weight: 10 g strength: approx. 8 kg	Price in CHF 5 pcs. 1.99 ea. from 15 pcs. 1.73 ea. from 40 pcs. 1.54 ea. from 80 pcs. 1.42 ea.	Pot diameter D: 16 mm Neck diameter d: 6 mm Pot height H1: 4.5 mm Total height without eyelet H2: 11.5 mm Total height with eyelet H3: 27 mm Thread M: 4
<b>OTN-25</b> Pot magnet Ø 25 mm with eyelet thread M4 Weight: 29 g strength: approx. 18 kg	Price in CHF 1 pc. 3.65 ea. from 3 pcs. 3.15 ea. from 10 pcs. 2.75 ea. from 20 pcs. 2.55 ea. from 40 pcs. 2.35 ea.	Pot diameter D: 25 mm Neck diameter d: 8 mm Pot height H1: 7 mm Total height without eyelet H2: 14 mm Total height with eyelet H3: 30 mm Thread M: 4
<b>OTN-32</b> Pot magnet Ø 32 mm with eyelet thread M5 Weight: 53 g strength: approx. 30 kg	Price in CHF 1 pc. 4.80 ea. from 3 pcs. 4.20 ea. from 10 pcs. 3.65 ea. from 20 pcs. 3.40 ea. from 40 pcs. 3.15 ea.	Pot diameter D: 32 mm Neck diameter d: 10 mm Pot height H1: 7 mm Total height without eyelet H2: 15.5 mm Total height with eyelet H3: 45 mm Thread M: 5
<b>OTN-40</b> Pot magnet Ø 40 mm with eyelet thread M6 Weight: 110 g strength: approx. 55 kg	Price in CHF 1 pc. 9.55 ea. from 3 pcs. 8.45 ea. from 10 pcs. 7.45 ea. from 20 pcs. 7.00 ea. from 40 pcs. 6.55 ea.	Pot diameter D: 40 mm Neck diameter d: 15 mm Pot height H1: 9 mm Total height without eyelet H2: 18 mm Total height with eyelet H3: 59 mm Thread M: 6
<b>OTNW-16</b> Pot magnet white Ø 16.3 mm with eyelet powder-coated thread M4 Weight: 11 g strength: approx. 6 kg	Price in CHF 1 pc. 2.45 ea. from 3 pcs. 2.15 ea. from 10 pcs. 1.90 ea. from 20 pcs. 1.75 ea. from 40 pcs. 1.65 ea.	Pot diameter D: 16.3 mm Neck diameter d: 6.3 mm Pot height H1: 4.8 mm Total height without eyelet H2: 11.8 mm Total height with eyelet H3: 27.3 mm Thread M: 4
<b>OTNW-25</b> Pot magnet white Ø 25.3 mm with eyelet powder-coated thread M4 Weight: 30 g strength: approx. 16 kg	Price in CHF 1 pc. 4.10 ea. from 3 pcs. 3.60 ea. from 10 pcs. 3.15 ea. from 20 pcs. 2.95 ea. from 40 pcs. 2.75 ea.	Pot diameter D: 25.3 mm Neck diameter d: 8.3 mm Pot height H1: 7.3 mm Total height without eyelet H2: 14.3 mm Total height with eyelet H3: 30.3 mm Thread M: 4



<b>OTNW-32</b> Pot magnet white Ø 32.3 mm with eyelet powder-coated thread M5 Weight: 56 g strength: approx. 28 kg		Price in CHF	Pot diameter D: 32.3 mm Neck diameter d: 10.3 mm Pot height H1: 7.3 mm Total height without eyelet H2: 15.8 mm Total height with eyelet H3: 45.3 mm Thread M: 5
		1 pc. 5.55 ea.	
	from	3 pcs. 4.90 ea.	
	from	10 pcs. 4.35 ea.	
	from	20 pcs. 4.05 ea.	
	from	40 pcs. 3.80 ea.	
<b>OTNW-40</b> Pot magnet white Ø 40.3 mm with eyelet powder-coated thread M6 Weight: 120 g strength: approx. 50 kg		Price in CHF	Pot diameter D: 40.3 mm Neck diameter d: 15.3 mm Pot height H1: 9.3 mm Total height without eyelet H2: 18.3 mm Total height with eyelet H3: 59.3 mm Thread M: 6
		1 pc. 10.40 ea.	
	from	3 pcs. 9.20 ea.	
	from	10 pcs. 8.15 ea.	
	from	20 pcs. 7.65 ea.	
	from	40 pcs. 7.20 ea.	

## Glue-in pot magnets

Distinctive feature: These magnets are glued into indentations when screwing is not possible.

Principle: The magnets are embedded in a steel pot. The steel pot increases the adhesive force of the magnet on direct contact with a thick iron surface. If there is no direct contact with the counterpart, or if the steel plate is thin, painted or rough, you won't be able to put as much strain on it.

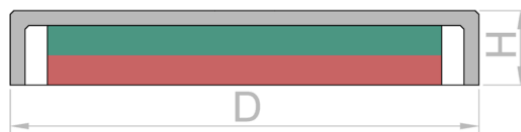

Shear force: The indicated adhesive force was measured perpendicular to the surface to which the magnet should stick. It takes a lot less strength to move the magnet sideways. Therefore, you won't be able to put as much strain on a pot magnet if you use it on a wall as opposed to using it on the ceiling.

© supermagnete.com

Rust: These magnets are not rust-proof and therefore intended for dry indoor use.

<b>FGN-10</b> Glue-in pot magnet Ø 10 mm Weight: 2.5 g strength: approx. 2.2 kg	Price in CHF 5 pcs. 1.41 ea. from 15 pcs. 1.22 ea. from 40 pcs. 1.08 ea. from 80 pcs. 0.99 ea.	Pot diameter D: 10 mm Pot height H: 5 mm Tolerance: +/- 0.1 mm Magnetisation: N38 Coating: nickel-coated (Ni-Cu-Ni) Max. working temperature: 80°C
<b>FGN-13</b> Glue-in pot magnet Ø 13 mm Weight: 4 g strength: approx. 3.2 kg	Price in CHF 5 pcs. 1.59 ea. from 15 pcs. 1.38 ea. from 40 pcs. 1.22 ea. from 80 pcs. 1.13 ea.	Pot diameter D: 13 mm Pot height H: 5 mm Tolerance: +/- 0.1 mm Magnetisation: N38 Coating: nickel-coated (Ni-Cu-Ni) Max. working temperature: 80°C
<b>FGN-16</b> Glue-in pot magnet Ø 16 mm Weight: 7 g strength: approx. 5.5 kg	Price in CHF 5 pcs. 1.83 ea. from 15 pcs. 1.58 ea. from 40 pcs. 1.40 ea. from 80 pcs. 1.29 ea.	Pot diameter D: 16 mm Pot height H: 5 mm Tolerance: +/- 0.1 mm Magnetisation: N38 Coating: nickel-coated (Ni-Cu-Ni) Max. working temperature: 80°C
<b>FGN-20</b> Glue-in pot magnet Ø 20 mm Weight: 14 g strength: approx. 9 kg	Price in CHF 1 pc. 3.05 ea. from 3 pcs. 2.65 ea. from 10 pcs. 2.25 ea. from 20 pcs. 2.05 ea. from 40 pcs. 1.90 ea.	Pot diameter D: 20 mm Pot height H: 7 mm Tolerance: +/- 0.1 mm Magnetisation: N38 Coating: nickel-coated (Ni-Cu-Ni) Max. working temperature: 80°C
<b>FGN-25</b> Glue-in pot magnet Ø 25 mm Weight: 27 g strength: approx. 22 kg	Price in CHF 1 pc. 3.80 ea. from 3 pcs. 3.35 ea. from 10 pcs. 2.95 ea. from 20 pcs. 2.75 ea. from 40 pcs. 2.55 ea.	Pot diameter D: 25 mm Pot height H: 8 mm Tolerance: +/- 0.1 mm Magnetisation: N38 Coating: nickel-coated (Ni-Cu-Ni) Max. working temperature: 80°C
<b>FGN-32</b> Glue-in pot magnet Ø 32 mm Weight: 43 g strength: approx. 34 kg	Price in CHF 1 pc. 3.95 ea. from 3 pcs. 3.45 ea. from 10 pcs. 3.05 ea. from 20 pcs. 2.85 ea. from 40 pcs. 2.70 ea.	Pot diameter D: 32 mm Pot height H: 8 mm Tolerance: +/- 0.1 mm Magnetisation: N38 Coating: nickel-coated (Ni-Cu-Ni) Max. working temperature: 80°C

<b>FGN-42</b> Glue-in pot magnet Ø 42 mm Weight: 85 g strength: approx. 68 kg		Price in CHF	Pot diameter D: 42 mm
		1 pc.	8.50 ea.
	from	3 pcs.	7.60 ea.
	from	10 pcs.	6.85 ea.
	from	20 pcs.	6.45 ea.
	from	40 pcs.	6.10 ea.
			Pot height H: 9 mm
			Tolerance: +/- 0.1 mm
			Magnetisation: N38
			Coating: nickel-coated (Ni-Cu-Ni)
			Max. working temperature: 80°C
<b>FGN-48</b> Glue-in pot magnet Ø 48 mm Weight: 130 g strength: approx. 85 kg		Price in CHF	Pot diameter D: 48 mm
		1 pc.	12.80 ea.
	from	3 pcs.	11.25 ea.
	from	10 pcs.	9.90 ea.
	from	20 pcs.	9.25 ea.
	from	40 pcs.	8.70 ea.
			Pot height H: 11.5 mm
			Tolerance: +/- 0.1 mm
			Magnetisation: N42
			Coating: nickel-coated (Ni-Cu-Ni)
			Max. working temperature: 80°C
<b>FGN-60</b> Glue-in pot magnet Ø 60 mm Weight: 280 g strength: approx. 130 kg		Price in CHF	Pot diameter D: 60 mm
		1 pc.	21.70 ea.
	from	3 pcs.	19.80 ea.
	from	10 pcs.	18.05 ea.
	from	20 pcs.	17.25 ea.
	from	40 pcs.	16.50 ea.
			Pot height H: 15 mm
			Tolerance: +/- 0.1 mm
			Magnetisation: N42
			Coating: nickel-coated (Ni-Cu-Ni)
			Max. working temperature: 80°C

## Pot magnets with internal thread

Distinctive feature: These magnets have a metric internal thread and can be fastened with objects with an external thread.

Principle: The magnets are embedded in a steel pot. The steel pot increases the adhesive force of the magnet on direct contact with a thick iron surface. If there is no direct contact with the counterpart, or if the steel plate is thin, painted or rough, you won't be able to put as much strain on it.

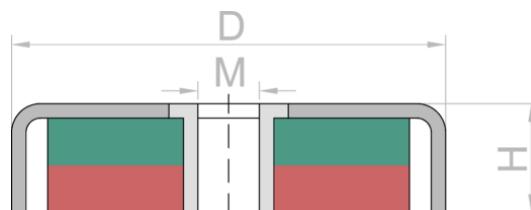

Shear force: The indicated adhesive force was measured perpendicular to the surface to which the magnet should stick. It takes a lot less strength to move the magnet sideways. Therefore, you won't be able to put as much strain on a pot magnet if you use it on a wall as opposed to using it on the ceiling.

Rust: These magnets are not rust-proof and therefore intended for dry indoor use.

<b>ITN-10</b> Pot magnet Ø 10 mm with internal thread thread M3 Weight: 2.5 g strength: approx. 1.2 kg	Price in CHF 5 pcs. 1.57 ea. from 15 pcs. 1.35 ea. from 40 pcs. 1.19 ea. from 80 pcs. 1.09 ea.	Pot diameter D: 10 mm Pot height H: 4.5 mm Thread M: 3 Tolerance: +/- 0.1 mm Magnetisation: N38 Coating: nickel-coated (Ni-Cu-Ni)
<b>ITN-13</b> Pot magnet Ø 13 mm with internal thread thread M3 Weight: 4.3 g strength: approx. 3 kg	Price in CHF 5 pcs. 1.69 ea. from 15 pcs. 1.46 ea. from 40 pcs. 1.29 ea. from 80 pcs. 1.18 ea.	Pot diameter D: 13 mm Pot height H: 4.5 mm Thread M: 3 Tolerance: +/- 0.1 mm Magnetisation: N38 Coating: nickel-coated (Ni-Cu-Ni)
<b>ITN-16</b> Pot magnet Ø 16 mm with internal thread thread M4 Weight: 6.3 g strength: approx. 5.2 kg	Price in CHF 5 pcs. 1.88 ea. from 15 pcs. 1.63 ea. from 40 pcs. 1.44 ea. from 80 pcs. 1.33 ea.	Pot diameter D: 16 mm Pot height H: 4.5 mm Thread M: 4 Tolerance: +/- 0.1 mm Magnetisation: N38 Coating: nickel-coated (Ni-Cu-Ni)
<b>ITN-20</b> Pot magnet Ø 20 mm with internal thread thread M4 Weight: 11 g strength: approx. 7.6 kg	Price in CHF 1 pc. 3.20 ea. from 3 pcs. 2.75 ea. from 10 pcs. 2.40 ea. from 20 pcs. 2.20 ea. from 40 pcs. 2.00 ea.	Pot diameter D: 20 mm Pot height H: 6 mm Thread M: 4 Tolerance: +/- 0.1 mm Magnetisation: N38 Coating: nickel-coated (Ni-Cu-Ni)
<b>ITN-25</b> Pot magnet Ø 25 mm with internal thread thread M5 Weight: 21 g strength: approx. 14 kg	Price in CHF 1 pc. 4.00 ea. from 3 pcs. 3.50 ea. from 10 pcs. 3.00 ea. from 20 pcs. 2.80 ea. from 40 pcs. 2.60 ea.	Pot diameter D: 25 mm Pot height H: 7 mm Thread M: 5 Tolerance: +/- 0.1 mm Magnetisation: N38 Coating: nickel-coated (Ni-Cu-Ni)
<b>ITN-32</b> Pot magnet Ø 32 mm with internal thread thread M6 Weight: 36 g strength: approx. 26 kg	Price in CHF 1 pc. 5.70 ea. from 3 pcs. 5.00 ea. from 10 pcs. 4.35 ea. from 20 pcs. 4.05 ea. from 40 pcs. 3.75 ea.	Pot diameter D: 32 mm Pot height H: 7 mm Thread M: 6 Tolerance: +/- 0.1 mm Magnetisation: N38 Coating: nickel-coated (Ni-Cu-Ni)

<b>ITN-40</b> Pot magnet Ø 40 mm with internal thread thread M6 Weight: 68 g strength: approx. 40 kg		Price in CHF	Pot diameter D: 40 mm
		1 pc.	9.30 ea.
	from	3 pcs.	8.20 ea.
	from	10 pcs.	7.20 ea.
	from	20 pcs.	6.70 ea.
	from	40 pcs.	6.30 ea.
			Pot height H: 8 mm
			Thread M: 6
			Tolerance: +/- 0.1 mm
			Magnetisation: N38
			Coating: nickel-coated (Ni-Cu-Ni)
<b>ITN-48</b> Pot magnet Ø 48 mm with internal thread thread M8 Weight: 140 g strength: approx. 58 kg		Price in CHF	Pot diameter D: 48 mm
		1 pc.	12.10 ea.
	from	3 pcs.	10.70 ea.
	from	10 pcs.	9.40 ea.
	from	20 pcs.	8.80 ea.
	from	40 pcs.	8.25 ea.
			Pot height H: 11.5 mm
			Thread M: 8
			Tolerance: +/- 0.1 mm
			Magnetisation: N38
			Coating: nickel-coated (Ni-Cu-Ni)
<b>ITN-60</b> Pot magnet Ø 60 mm with internal thread thread M8 Weight: 260 g strength: approx. 92 kg		Price in CHF	Pot diameter D: 60 mm
		1 pc.	22.30 ea.
	from	3 pcs.	19.75 ea.
	from	10 pcs.	17.45 ea.
	from	20 pcs.	16.35 ea.
	from	40 pcs.	15.40 ea.
			Pot height H: 15 mm
			Thread M: 8
			Tolerance: +/- 0.1 mm
			Magnetisation: N38
			Coating: nickel-coated (Ni-Cu-Ni)

## Pot magnets with counterbore hole screw-on

Distinctive feature: These magnets can be fastened with a screw without countersink.

Principle: The magnets are embedded in a steel pot. The steel pot increases the adhesive force of the magnet on direct contact with a thick iron surface. If there is no direct contact with the counterpart, or if the steel plate is thin, painted or rough, you can strain it much less.

Shear force: The indicated adhesive force was measured perpendicular to the surface to which the magnet should stick. It takes a lot less strength to move the magnet sideways. Therefore, you can put less strain on a pot magnet if you use it on a wall as opposed to using it on the ceiling.

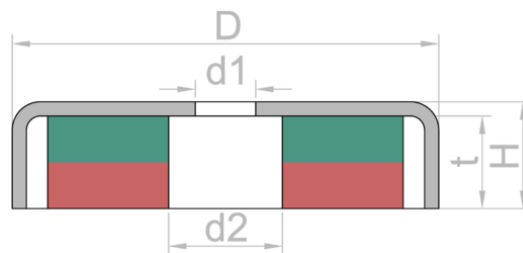

© supermagnete.com

Rust: These magnets are not rust-proof and therefore intended for dry indoor use.

<b>ZTN-16</b> Pot magnet Ø 16 mm with counterbore hole Weight: 6 g strength: approx. 4 kg	Price in CHF 5 pcs. 1.52 ea. from 15 pcs. 1.31 ea. from 40 pcs. 1.16 ea. from 80 pcs. 1.07 ea.	Pot diameter D: 16 mm Pot height H: 5 mm Hole d1: 3.5 mm Hole d2: 6.5 mm Depth t: 3.8 mm Tolerance: +/- 0.1 mm
<b>ZTN-20</b> Pot magnet Ø 20 mm with counterbore hole Weight: 12 g strength: approx. 6 kg	Price in CHF 1 pc. 2.70 ea. from 3 pcs. 2.35 ea. from 10 pcs. 2.05 ea. from 20 pcs. 1.85 ea. from 40 pcs. 1.75 ea.	Pot diameter D: 20 mm Pot height H: 7 mm Hole d1: 4.5 mm Hole d2: 8 mm Depth t: 5.5 mm Tolerance: +/- 0.1 mm
<b>ZTN-25</b> Pot magnet Ø 25 mm with counterbore hole Weight: 23 g strength: approx. 14 kg	Price in CHF 1 pc. 3.25 ea. from 3 pcs. 2.80 ea. from 10 pcs. 2.45 ea. from 20 pcs. 2.25 ea. from 40 pcs. 2.10 ea.	Pot diameter D: 25 mm Pot height H: 8 mm Hole d1: 5.5 mm Hole d2: 9 mm Depth t: 6 mm Tolerance: +/- 0.1 mm
<b>ZTN-32</b> Pot magnet Ø 32 mm with counterbore hole Weight: 36 g strength: approx. 23 kg	Price in CHF 1 pc. 4.60 ea. from 3 pcs. 4.05 ea. from 10 pcs. 3.55 ea. from 20 pcs. 3.30 ea. from 40 pcs. 3.05 ea.	Pot diameter D: 32 mm Pot height H: 8 mm Hole d1: 5.5 mm Hole d2: 9 mm Depth t: 5.5 mm Tolerance: +/- 0.1 mm
<b>ZTN-42</b> Pot magnet Ø 42 mm with counterbore hole Weight: 73 g strength: approx. 32 kg	Price in CHF 1 pc. 7.55 ea. from 3 pcs. 6.75 ea. from 10 pcs. 6.00 ea. from 20 pcs. 5.65 ea. from 40 pcs. 5.30 ea.	Pot diameter D: 42 mm Pot height H: 9 mm Hole d1: 6.5 mm Hole d2: 11 mm Depth t: 6 mm Tolerance: +/- 0.1 mm
<b>ZTN-48</b> Pot magnet Ø 48 mm with counterbore hole Weight: 110 g strength: approx. 63 kg	Price in CHF 1 pc. 10.15 ea. from 3 pcs. 9.00 ea. from 10 pcs. 7.95 ea. from 20 pcs. 7.45 ea. from 40 pcs. 7.00 ea.	Pot diameter D: 48 mm Pot height H: 11.5 mm Hole d1: 8.5 mm Hole d2: 15 mm Depth t: 8.5 mm Tolerance: +/- 0.1 mm

**ZTN-60**

Pot magnet Ø 60 mm with  
counterbore hole

Weight: 240 g  
strength: approx. 95 kg

Price in CHF

1 pc. 20.75 ea.

from 3 pcs. 18.80 ea.

from 10 pcs. 17.10 ea.

from 20 pcs. 16.25 ea.

from 40 pcs. 15.50 ea.

Pot diameter D: 60 mm

Pot height H: 15 mm

Hole d1: 8.5 mm

Hole d2: 15 mm

Depth t: 11.5 mm

Tolerance: +/- 0.1 mm

## Pot magnets with screw socket

Distinctive feature: These pot magnets have a screw socket, into which you can screw hooks, eyelets, etc. We also carry identical hook magnets as well as eyelet magnets.

Principle: The strong neodymium magnets are embedded in a steel pot. The steel pot increases the adhesive force of the magnet on direct contact with a thick iron surface. If there is no direct contact with the counterpart, or if the steel plate is thin, painted or rough, you won't be able to put as much strain on it.

Shear force: The indicated adhesive force was measured perpendicular to the surface to which the magnet should stick. It takes a lot less strength to move the magnet sideways. Therefore, you won't be able to put as much strain on a pot magnet if you use it on a wall as opposed to using it on the ceiling.

Rust: These magnets are not rust-proof and therefore intended for dry indoor use.

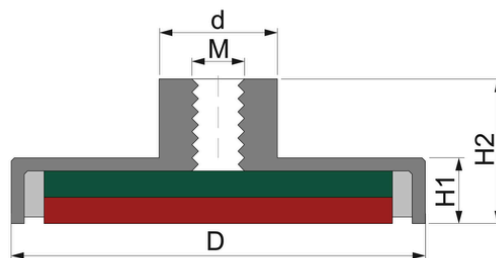

supermagnete.com

<b>TCN-10</b> Pot magnet Ø 10 mm with screw socket thread M3 Weight: 3.8 g strength: approx. 3 kg	Price in CHF 5 pcs. 1.31 ea. from 15 pcs. 1.13 ea. from 40 pcs. 0.99 ea. from 80 pcs. 0.91 ea.	Pot diameter D: 10 mm Neck diameter d: 5 mm Pot height H1: 4.5 mm Total height H2: 11.5 mm Thread M: 3 Tolerance: +/- 0.1 mm
<b>TCN-13</b> Pot magnet Ø 13 mm with screw socket thread M3 Weight: 5.3 g strength: approx. 5 kg	Price in CHF 5 pcs. 1.65 ea. from 15 pcs. 1.44 ea. from 40 pcs. 1.28 ea. from 80 pcs. 1.18 ea.	Pot diameter D: 13 mm Neck diameter d: 5 mm Pot height H1: 4.5 mm Total height H2: 11.5 mm Thread M: 3 Tolerance: +/- 0.1 mm
<b>TCN-16</b> Pot magnet Ø 16 mm with screw socket thread M4 Weight: 7.7 g strength: approx. 8 kg	Price in CHF 5 pcs. 1.67 ea. from 15 pcs. 1.45 ea. from 40 pcs. 1.30 ea. from 80 pcs. 1.20 ea.	Pot diameter D: 16 mm Neck diameter d: 6 mm Pot height H1: 4.5 mm Total height H2: 11.5 mm Thread M: 4 Tolerance: +/- 0.1 mm
<b>TCN-20</b> Pot magnet Ø 20 mm with screw socket thread M4 Weight: 17 g strength: approx. 13 kg	Price in CHF 1 pc. 2.70 ea. from 3 pcs. 2.30 ea. from 10 pcs. 2.00 ea. from 20 pcs. 1.85 ea. from 40 pcs. 1.70 ea.	Pot diameter D: 20 mm Neck diameter d: 8 mm Pot height H1: 6 mm Total height H2: 13 mm Thread M: 4 Tolerance: +/- 0.1 mm
<b>TCN-25</b> Pot magnet Ø 25 mm with screw socket thread M4 Weight: 27 g strength: approx. 18 kg	Price in CHF 1 pc. 3.20 ea. from 3 pcs. 2.80 ea. from 10 pcs. 2.45 ea. from 20 pcs. 2.30 ea. from 40 pcs. 2.15 ea.	Pot diameter D: 25 mm Neck diameter d: 8 mm Pot height H1: 7 mm Total height H2: 14 mm Thread M: 4 Tolerance: +/- 0.1 mm
<b>TCN-32</b> Pot magnet Ø 32 mm with screw socket thread M5 Weight: 44 g strength: approx. 30 kg	Price in CHF 1 pc. 4.10 ea. from 3 pcs. 3.60 ea. from 10 pcs. 3.15 ea. from 20 pcs. 2.95 ea. from 40 pcs. 2.75 ea.	Pot diameter D: 32 mm Neck diameter d: 10 mm Pot height H1: 7 mm Total height H2: 15.5 mm Thread M: 5 Tolerance: +/- 0.1 mm



<p><b>TCN-40</b> Pot magnet Ø 40 mm with screw socket thread M6 Weight: 97 g strength: approx. 55 kg</p>	<p>Price in CHF</p> <p>1 pc. 7.65 ea.</p> <p>from 3 pcs. 6.80 ea.</p> <p>from 10 pcs. 6.05 ea.</p> <p>from 20 pcs. 5.70 ea.</p> <p>from 40 pcs. 5.40 ea.</p>	<p>Pot diameter D: 40 mm Neck diameter d: 15 mm Pot height H1: 9 mm Total height H2: 18 mm Thread M: 6 Tolerance: +/- 0.1 mm</p>
<p><b>TCN-50</b> Pot magnet Ø 50 mm with screw socket thread M8 Weight: 140 g strength: approx. 75 kg</p>	<p>Price in CHF</p> <p>1 pc. 11.30 ea.</p> <p>from 3 pcs. 10.00 ea.</p> <p>from 10 pcs. 8.90 ea.</p> <p>from 20 pcs. 8.35 ea.</p> <p>from 40 pcs. 7.85 ea.</p>	<p>Pot diameter D: 50 mm Neck diameter d: 15 mm Pot height H1: 9 mm Total height H2: 18 mm Thread M: 8 Tolerance: +/- 0.1 mm</p>
<p><b>TCN-63</b> Pot magnet Ø 63 mm with screw socket thread M8 Weight: 240 g strength: approx. 110 kg</p>	<p>Price in CHF</p> <p>1 pc. 19.55 ea.</p> <p>from 3 pcs. 17.65 ea.</p> <p>from 10 pcs. 15.95 ea.</p> <p>from 20 pcs. 15.15 ea.</p> <p>from 40 pcs. 14.40 ea.</p>	<p>Pot diameter D: 63 mm Neck diameter d: 18 mm Pot height H1: 10 mm Total height H2: 22 mm Thread M: 8 Tolerance: +/- 0.1 mm</p>

## Pot magnets & magnet systems with ferrite magnets

Distinctive feature: These magnets are ferrite and not neodymium magnets. They have therefore a lower adhesive force and are larger. But are cheaper than neodymium magnets and can be used outside as well.

Principle: The magnets are embedded in a steel pot. The steel pot increases the adhesive force of the magnet on direct contact with a thick iron surface. If there is no direct contact with the counterpart, or if the steel plate is thin, painted or rough, you won't be able to put as much strain on it.

Shear force: The indicated adhesive force was measured perpendicular to the surface to which the magnet should stick. It takes a lot less strength to move the magnet sideways. Therefore, you won't be able to put as much strain on a pot magnet if you use it on a wall as opposed to using it on the ceiling.

Rust: These magnets are rust-proof and can therefore be used outside and in wet surroundings as well. The pots surrounding the magnets, however, may develop surface rust over time.

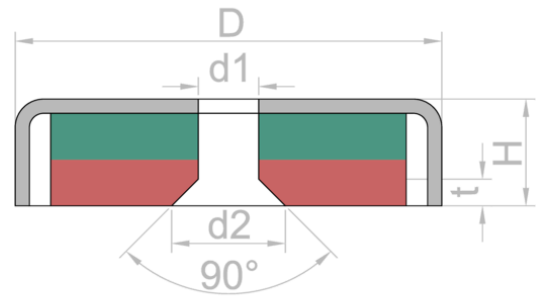

© supermagnete.com

<p><b>SF-MBF-01</b> Magnetic holder vertical for poster frames ferrite magnet system in plastic housing with vertical adapter Weight: 42 g</p>	<p>Price in CHF</p> <p>5 pcs. 1.37 ea. from 15 pcs. 1.19 ea. from 40 pcs. 1.05 ea. from 80 pcs. 0.97 ea.</p>	<p>Practical ferrite magnet holder with vertical (upward facing) adapter for attaching sign frames to ferromagnetic surfaces. The magnetic holder allows easy and flexible positioning of poster frames in no time.</p>
<p><b>SF-MBF-02</b> Magnetic holder horizontal for poster frames ferrite magnet system in plastic housing with horizontal adapter Weight: 43 g</p>	<p>Price in CHF</p> <p>5 pcs. 1.38 ea. from 15 pcs. 1.19 ea. from 40 pcs. 1.06 ea. from 80 pcs. 0.98 ea.</p>	<p>Practical ferrite magnetic holder with horizontal adapter for attaching sign frames to ferromagnetic surfaces.</p>
<p><b>SF-MBH-01</b> Magnetic banner hanger, straight with two plastic hooks with push button 180° rotatable Weight: 150 g</p>	<p>Price in CHF</p> <p>1 pc. 5.35 ea. from 3 pcs. 4.60 ea. from 10 pcs. 3.95 ea. from 20 pcs. 3.65 ea. from 40 pcs. 3.35 ea.</p>	<p>Length: 71 mm Length mast: 285 mm Width: 38 mm Height 1: 16 mm Height 2: 32 mm Hook length: 25 mm</p>
<p><b>SF-MBH-02</b> Magnetic banner hanger, angled with two plastic hooks with push button 180° rotatable Weight: 150 g</p>	<p>Price in CHF</p> <p>1 pc. 5.65 ea. from 3 pcs. 4.90 ea. from 10 pcs. 4.25 ea. from 20 pcs. 3.90 ea. from 40 pcs. 3.60 ea.</p>	<p>This magnetic banner hanger consists of a ferrite magnet system and an attached angled arm with two plastic hooks. Very versatile as a point-of-purchase display in retail settings.</p>
<p><b>SF-MBS-01</b> Magnetic boot system, holds approx. 20 kg ferrite magnet system in plastic housing with rectangular slide-in adapter Weight: 110 g strength: approx. 20 kg</p>	<p>Price in CHF</p> <p>1 pc. 2.55 ea. from 3 pcs. 2.25 ea. from 10 pcs. 1.95 ea. from 20 pcs. 1.80 ea. from 40 pcs. 1.65 ea.</p>	<p>Strong magnetic boot system with rectangular insertion adapter. Place two of these magnets on a ferromagnetic surface to attach rigid signs.</p>
<p><b>SF-MGS-01</b> Gripper sign holder magnetic, holds approx. 10 kg with horizontal, flush gripper made of plastic Weight: 63 g strength: approx. 10 kg</p>	<p>Price in CHF</p> <p>5 pcs. 1.72 ea. from 15 pcs. 1.51 ea. from 40 pcs. 1.36 ea. from 80 pcs. 1.26 ea.</p>	<p>Sturdy magnetic sign holder with ferrite channel magnet and large clip made of transparent PVC. Perfect for retail or warehouse use.</p>

<p><b>SF-MGS-02</b> Gripper sign holder magnetic, holds approx. 10 kg with vertical, upward pointing gripper made of plastic Weight: 62 g strength: approx. 10 kg</p>	<p>Price in CHF</p> <p>5 pcs. 1.59 ea. from 15 pcs. 1.39 ea. from 40 pcs. 1.24 ea. from 80 pcs. 1.15 ea.</p>	<p>Sturdy magnetic sign holder with ferrite channel magnet and short clip made of transparent PVC. Perfect for retail and warehouse use.</p>
<p><b>SF-MGS-03</b> Gripper sign holder magnetic, holds approx. 10 kg with vertical, upward pointing gripper made of plastic Weight: 62 g strength: approx. 10 kg</p>	<p>Price in CHF</p> <p>1 pc. 2.25 ea. from 3 pcs. 2.00 ea. from 10 pcs. 1.75 ea. from 20 pcs. 1.60 ea. from 40 pcs. 1.50 ea.</p>	<p>Sturdy magnetic sign holder with ferrite channel magnet and flexible clip made of transparent PVC. Perfect for retail or warehouse use.</p>
<p><b>SF-MGS-04</b> Gripper sign holder magnetic, holds approx. 10 kg with vertical, upward pointing gripper made of plastic Weight: 62 g strength: approx. 10 kg</p>	<p>Price in CHF</p> <p>1 pc. 2.20 ea. from 3 pcs. 1.90 ea. from 10 pcs. 1.65 ea. from 20 pcs. 1.50 ea. from 40 pcs. 1.40 ea.</p>	<p>Sturdy magnetic sign holder with ferrite channel magnet and large clip made of transparent PVC. Perfect for retail or warehouse use.</p>
<p><b>SF-MRF-01</b> Rotating holder magnetic, holds approx. 1 kg ferrite magnet system in plastic housing with push button 180° rotatable Weight: 130 g strength: approx. 1 kg</p>	<p>Price in CHF</p> <p>1 pc. 3.10 ea. from 3 pcs. 2.70 ea. from 10 pcs. 2.35 ea. from 20 pcs. 2.20 ea. from 40 pcs. 2.05 ea.</p>	<p>Length: 71 mm Length 2: 88 mm Width: 38 mm Height 1: 16 mm Height 2: 105 mm Opening for poster frame: 8.5 mm</p>
<p><b>CSF-25</b> Ferrite pot magnet with countersunk hole Ø 25 mm Weight: 16 g strength: approx. 2.2 kg</p>	<p>Price in CHF</p> <p>5 pcs. 1.33 ea. from 15 pcs. 1.15 ea. from 40 pcs. 1.02 ea. from 80 pcs. 0.94 ea.</p>	<p>Pot diameter D: 25 mm Pot height H: 7 mm Hole d1: 5.5 mm Hole d2: 11.7 mm Countersink t: 3.1 mm Magnetisation: Y30BH</p>
<p><b>CSF-40</b> Ferrite pot magnet with countersunk hole Ø 40 mm Weight: 50 g strength: approx. 16 kg</p>	<p>Price in CHF</p> <p>5 pcs. 1.65 ea. from 15 pcs. 1.44 ea. from 40 pcs. 1.28 ea. from 80 pcs. 1.19 ea.</p>	<p>Pot diameter D: 40 mm Pot height H: 8 mm Hole d1: 5.5 mm Hole d2: 11.7 mm Countersink t: 3.1 mm Magnetisation: Y30BH</p>
<p><b>CSF-48</b> Ferrite pot magnet with countersunk hole Ø 48 mm Weight: 110 g strength: approx. 23 kg</p>	<p>Price in CHF</p> <p>1 pc. 3.45 ea. from 3 pcs. 3.05 ea. from 10 pcs. 2.65 ea. from 20 pcs. 2.50 ea. from 40 pcs. 2.35 ea.</p>	<p>Pot diameter D: 48 mm Pot height H: 11.5 mm Hole d1: 8.5 mm Hole d2: 18.12 mm Countersink t: 4.81 mm Magnetisation: Y30BH</p>
<p><b>CSF-60</b> Ferrite pot magnet with countersunk hole Ø 60 mm Weight: 210 g strength: approx. 36 kg</p>	<p>Price in CHF</p> <p>1 pc. 4.75 ea. from 3 pcs. 4.20 ea. from 10 pcs. 3.75 ea. from 20 pcs. 3.50 ea. from 40 pcs. 3.30 ea.</p>	<p>Pot diameter D: 60 mm Pot height H: 15 mm Hole d1: 8.5 mm Hole d2: 18.12 mm Countersink t: 4.81 mm Magnetisation: Y30BH</p>
<p><b>ITF-25</b> Ferrite pot magnet with internal thread M4 Ø 25 mm Weight: 18 g strength: approx. 3.6 kg</p>	<p>Price in CHF</p> <p>1 pc. 2.90 ea. from 3 pcs. 2.55 ea. from 10 pcs. 2.25 ea. from 20 pcs. 2.10 ea. from 40 pcs. 1.95 ea.</p>	<p>Ferrite pot magnets with metric internal thread and heat resistance of up to 200°C.</p>

<p><b>ITF-32</b> Ferrite pot magnet with internal thread M4 Ø 32 mm Weight: 29 g strength: approx. 7.6 kg</p>	<p>Price in CHF</p> <p>1 pc. 2.90 ea. from 3 pcs. 2.60 ea. from 10 pcs. 2.30 ea. from 20 pcs. 2.15 ea. from 40 pcs. 2.00 ea.</p>	<p>Ferrite pot magnets with metric internal thread and heat resistance of up to 200°C.</p>
<p><b>ITF-40</b> Ferrite pot magnet with internal thread M4 Ø 40 mm Weight: 53 g strength: approx. 9.1 kg</p>	<p>Price in CHF</p> <p>1 pc. 3.55 ea. from 3 pcs. 3.15 ea. from 10 pcs. 2.75 ea. from 20 pcs. 2.60 ea. from 40 pcs. 2.40 ea.</p>	<p>Ferrite pot magnets with metric internal thread and heat resistance of up to 200°C.</p>
<p><b>ITF-50</b> Ferrite pot magnet with internal thread M8 Ø 50 mm Weight: 94 g strength: approx. 17 kg</p>	<p>Price in CHF</p> <p>1 pc. 4.25 ea. from 3 pcs. 3.85 ea. from 10 pcs. 3.45 ea. from 20 pcs. 3.30 ea. from 40 pcs. 3.15 ea.</p>	<p>Ferrite pot magnets with metric internal thread and heat resistance of up to 200°C.</p>
<p><b>MPH-34</b> Magnetic holder adjustable for poster frames, holds approx. 10 kg ferrite magnet system in plastic housing with adjustable adapter 180° pivoting angle Weight: 36 g strength: approx. 10 kg</p>	<p>Price in CHF</p> <p>1 pc. 1.70 ea. from 3 pcs. 1.55 ea. from 10 pcs. 1.45 ea. from 20 pcs. 1.40 ea. from 40 pcs. 1.35 ea.</p>	<p>This high-quality ferrite magnet holder for poster frames features a solid plastic housing and a sturdy 180° swivelling adapter.</p>
<p><b>WS-HOOK-01</b> Sandwich magnet with hook, holds approx. 15 kg ferrite magnet system in plastic housing rectangular, 53 x 27.5 mm Weight: 53 g strength: approx. 15 kg</p>	<p>Price in CHF</p> <p>1 pc. 3.80 ea. from 3 pcs. 3.30 ea. from 10 pcs. 2.85 ea. from 20 pcs. 2.60 ea. from 40 pcs. 2.40 ea.</p>	<p>Simple ferrite hook magnet with a white plastic housing features a slim and sturdy design, which makes it ideal for hanging up promotional material for product presentation.</p>
<p><b>WS-HOOK-02</b> Sandwich magnet with loop, holds approx. 30 kg ferrite magnet system in plastic housing square, 58 x 58 mm Weight: 130 g strength: approx. 30 kg</p>	<p>Price in CHF</p> <p>1 pc. 4.85 ea. from 3 pcs. 4.35 ea. from 10 pcs. 3.90 ea. from 20 pcs. 3.65 ea. from 40 pcs. 3.50 ea.</p>	<p>Strong ferrite eyelet magnet with a white plastic housing is ideal for discreetly hanging up promotional material for product presentation.</p>

## Screw hooks & eyelet bolts

<p><b>STH-4</b> screw hook 4 mm inner diameter steel, nickel-coated thread M3 Weight: 2 g</p>	<p>Price in CHF 10 pcs. 0.30 ea.</p>	<p>These practical, small screw hooks with an inner diameter of 4 mm can be fastened to any product with an M3 thread.</p>
<p><b>STH-5.5</b> screw hook 5.5 mm inner diameter steel, nickel-coated thread M4 Weight: 3 g</p>	<p>Price in CHF 10 pcs. 0.50 ea.</p>	<p>These practical, small screw hooks with an inner diameter of 5 mm can be fastened to any product with an M4 thread.</p>
<p><b>STH-14</b> screw hook 14 mm inner diameter steel, nickel-coated thread M5 Weight: 8 g</p>	<p>Price in CHF 5 pcs. 0.90 ea.</p>	<p>These practical screw hooks with an inner diameter of 14 mm can be fastened to any product with an M5 thread.</p>
<p><b>STH-22</b> screw hook 22 mm inner diameter steel, nickel-coated thread M8 Weight: 34 g</p>	<p>Price in CHF 1 pc. 1.10 ea.</p>	<p>These practical screw hooks with an inner diameter of 22 mm can be fastened to any product with an M8 thread.</p>
<p><b>STH-26</b> screw hook 26 mm inner diameter steel, nickel-coated thread M6 Weight: 19 g</p>	<p>Price in CHF 1 pc. 1.30 ea.</p>	<p>These practical screw hooks with an inner diameter of 26 mm can be fastened to any product with an M6 thread.</p>
<p><b>STE-4</b> threaded eyelet bolt 4 mm inner diameter steel, nickel-coated thread M4 Weight: 3 g</p>	<p>Price in CHF 10 pcs. 0.30 ea.</p>	<p>These practical, small threaded eye bolts with an inner diameter of 4 mm can be screwed into any product with an M4 thread.</p>
<p><b>STE-11</b> threaded eyelet bolt 11 mm inner diameter steel, nickel-coated thread M5 Weight: 9 g</p>	<p>Price in CHF 5 pcs. 0.90 ea.</p>	<p>These practical, small threaded eye bolts with an inner diameter of 11 mm can be screwed into any product with an M5 thread.</p>
<p><b>STE-19</b> threaded eyelet bolt 19 mm inner diameter steel, nickel-coated thread M6 Weight: 16 g</p>	<p>Price in CHF 1 pc. 1.10 ea.</p>	<p>These practical threaded eye bolts with an inner diameter of 19 mm can be screwed into any product with an M6 thread.</p>

## Deep pot magnets with neodymium magnets

<p><b>BMN-10</b> deep pot magnet Ø 10 mm with smooth housing Weight: 12 g strength: approx. 2.4 kg</p>	<p>Price in CHF</p> <p>5 pcs. 2.51 ea. from 15 pcs. 2.18 ea. from 40 pcs. 1.93 ea.</p>	<p>Diameter D: 10 mm Height H: 20 mm Trim without loss of adhesive force A: 15 mm Tolerance: +/- 0.2 mm Material magnet: Neodymium-NiCuNi plated Magnetisation: N42</p>
<p><b>BMN-13</b> deep pot magnet Ø 13 mm with smooth housing Weight: 21 g strength: approx. 6 kg</p>	<p>Price in CHF</p> <p>5 pcs. 2.55 ea. from 15 pcs. 2.22 ea. from 40 pcs. 1.98 ea. from 120 pcs. 1.75 ea.</p>	<p>Diameter D: 13 mm Height H: 20 mm Trim without loss of adhesive force A: 15 mm Material magnet: Neodymium-NiCuNi plated Tolerance: +/- 0.2 mm Magnetisation: N42</p>
<p><b>BMN-16</b> deep pot magnet Ø 16 mm with smooth housing Weight: 31 g strength: approx. 9 kg</p>	<p>Price in CHF</p> <p>1 pc. 3.20 ea. from 3 pcs. 2.80 ea. from 10 pcs. 2.40 ea. from 40 pcs. 2.05 ea. from 80 pcs. 1.90 ea.</p>	<p>Diameter D: 16 mm Height H: 20 mm Trim without loss of adhesive force A: 15 mm Tolerance: +/- 0.2 mm Material magnet: Neodymium-NiCuNi plated Magnetisation: N42</p>
<p><b>BMN-20</b> deep pot magnet Ø 20 mm with smooth housing Weight: 61 g strength: approx. 13 kg</p>	<p>Price in CHF</p> <p>1 pc. 3.85 ea. from 3 pcs. 3.35 ea. from 10 pcs. 2.90 ea. from 40 pcs. 2.45 ea. from 80 pcs. 2.30 ea.</p>	<p>Diameter D: 20 mm Height H: 25 mm Trim without loss of adhesive force A: 18 mm Tolerance: +/- 0.2 mm Material magnet: Neodymium-NiCuNi plated Magnetisation: N42</p>
<p><b>BMN-25</b> deep pot magnet Ø 25 mm with smooth housing Weight: 130 g strength: approx. 19 kg</p>	<p>Price in CHF</p> <p>1 pc. 5.20 ea. from 3 pcs. 4.55 ea. from 10 pcs. 4.00 ea. from 40 pcs. 3.45 ea. from 80 pcs. 3.20 ea.</p>	<p>Diameter D: 25 mm Height H: 35 mm Trim without loss of adhesive force A: 27 mm Tolerance: +/- 0.2 mm Material magnet: Neodymium-NiCuNi plated Magnetisation: N42</p>
<p><b>BMN-32</b> deep pot magnet Ø 32 mm with smooth housing Weight: 130 g strength: approx. 34 kg</p>	<p>Price in CHF</p> <p>1 pc. 7.35 ea. from 3 pcs. 6.45 ea. from 10 pcs. 5.65 ea. from 40 pcs. 4.85 ea.</p>	<p>Diameter D: 32 mm Height H: 40 mm Trim without loss of adhesive force A: 32 mm Tolerance: +/- 0.2 mm Material magnet: Neodymium-NiCuNi plated Magnetisation: N42</p>
<p><b>BMN-IT-10</b> deep pot magnet Ø 10 mm with internal thread thread M4 Weight: 9 g strength: approx. 2.4 kg</p>	<p>Price in CHF</p> <p>5 pcs. 2.90 ea. from 15 pcs. 2.53 ea. from 40 pcs. 2.25 ea.</p>	<p>Diameter D: 10 mm Height H: 16 mm Thread M: 4 Thread depth L: 7 mm Tolerance: +/- 0.2 mm Material magnet: Neodymium-NiCuNi plated</p>
<p><b>BMN-IT-13</b> deep pot magnet Ø 13 mm with internal thread thread M4 Weight: 20 g strength: approx. 6 kg</p>	<p>Price in CHF</p> <p>5 pcs. 3.38 ea. from 15 pcs. 2.98 ea. from 40 pcs. 2.68 ea.</p>	<p>Diameter D: 13 mm Height H: 20 mm Thread M: 4 Thread depth L: 8 mm Tolerance: +/- 0.2 mm Material magnet: Neodymium-NiCuNi plated</p>

<p><b>BMN-IT-16</b> deep pot magnet Ø 16 mm with internal thread thread M4 Weight: 30 g strength: approx. 9 kg</p>	<p>Price in CHF</p> <p>1 pc. 4.40 ea. from 3 pcs. 3.85 ea. from 10 pcs. 3.35 ea. from 40 pcs. 2.90 ea. from 80 pcs. 2.70 ea.</p>	<p>Diameter D: 16 mm Height H: 20 mm Thread M: 4 Thread depth L: 8 mm Tolerance: +/- 0.2 mm Material magnet: Neodymium-NiCuNi plated</p>
<p><b>BMN-IT-20</b> deep pot magnet Ø 20 mm with internal thread thread M6 Weight: 58 g strength: approx. 13 kg</p>	<p>Price in CHF</p> <p>1 pc. 4.00 ea. from 3 pcs. 3.50 ea. from 10 pcs. 3.05 ea. from 40 pcs. 2.60 ea. from 80 pcs. 2.40 ea.</p>	<p>Diameter D: 20 mm Height H: 25 mm Thread M: 6 Thread depth L: 9 mm Tolerance: +/- 0.2 mm Material magnet: Neodymium-NiCuNi plated</p>
<p><b>BMN-IT-25</b> deep pot magnet Ø 25 mm with internal thread thread M6 Weight: 130 g strength: approx. 19 kg</p>	<p>Price in CHF</p> <p>1 pc. 5.25 ea. from 3 pcs. 4.60 ea. from 10 pcs. 4.00 ea. from 40 pcs. 3.45 ea. from 80 pcs. 3.25 ea.</p>	<p>Diameter D: 25 mm Height H: 35 mm Thread M: 6 Thread depth L: 9 mm Tolerance: +/- 0.2 mm Material magnet: Neodymium-NiCuNi plated</p>
<p><b>BMN-IT-32</b> deep pot magnet Ø 32 mm with internal thread thread M8 Weight: 240 g strength: approx. 34 kg</p>	<p>Price in CHF</p> <p>1 pc. 7.70 ea. from 3 pcs. 6.80 ea. from 10 pcs. 6.05 ea. from 40 pcs. 5.30 ea. from 80 pcs. 4.95 ea.</p>	<p>Diameter D: 32 mm Height H: 40 mm Thread M: 8 Thread depth L: 12 mm Tolerance: +/- 0.2 mm Material magnet: Neodymium-NiCuNi plated</p>
<p><b>BMN-PP-10</b> deep pot magnet Ø 10 mm with stud stud Ø 4 mm Weight: 13 g strength: approx. 2.4 kg</p>	<p>Price in CHF</p> <p>5 pcs. 2.58 ea. from 15 pcs. 2.24 ea. from 40 pcs. 1.99 ea.</p>	<p>Diameter D: 10 mm Height H1: 20 mm Height H2: 28 mm Diameter stud d: 4 mm Tolerance: +/- 0.2 mm Material magnet: Neodymium-NiCuNi plated</p>
<p><b>BMN-PP-13</b> deep pot magnet Ø 13 mm with stud stud Ø 4 mm Weight: 21 g strength: approx. 6 kg</p>	<p>Price in CHF</p> <p>5 pcs. 2.72 ea. from 15 pcs. 2.37 ea. from 40 pcs. 2.11 ea. from 120 pcs. 1.86 ea.</p>	<p>Diameter D: 13 mm Height H1: 20 mm Height H2: 28 mm Diameter stud d: 4 mm Tolerance: +/- 0.2 mm Material magnet: Neodymium-NiCuNi plated</p>
<p><b>BMN-PP-16</b> deep pot magnet Ø 16 mm with stud stud Ø 5 mm Weight: 31 g strength: approx. 9 kg</p>	<p>Price in CHF</p> <p>1 pc. 3.45 ea. from 3 pcs. 3.00 ea. from 10 pcs. 2.60 ea. from 40 pcs. 2.25 ea. from 80 pcs. 2.05 ea.</p>	<p>Diameter D: 16 mm Height H1: 20 mm Height H2: 28 mm Diameter stud d: 5 mm Tolerance: +/- 0.2 mm Material magnet: Neodymium-NiCuNi plated</p>
<p><b>BMN-PP-20</b> deep pot magnet Ø 20 mm with stud stud Ø 6 mm Weight: 61 g strength: approx. 13 kg</p>	<p>Price in CHF</p> <p>1 pc. 4.10 ea. from 3 pcs. 3.55 ea. from 10 pcs. 3.10 ea. from 40 pcs. 2.60 ea. from 80 pcs. 2.45 ea.</p>	<p>Diameter D: 20 mm Height H1: 25 mm Height H2: 33 mm Diameter stud d: 6 mm Tolerance: +/- 0.2 mm Material magnet: Neodymium-NiCuNi plated</p>
<p><b>BMN-PP-25</b> deep pot magnet Ø 25 mm with stud stud Ø 8 mm Weight: 130 g strength: approx. 19 kg</p>	<p>Price in CHF</p> <p>1 pc. 5.25 ea. from 3 pcs. 4.55 ea. from 10 pcs. 3.95 ea. from 40 pcs. 3.35 ea.</p>	<p>Diameter D: 25 mm Height H1: 35 mm Height H2: 45 mm Diameter stud d: 8 mm Tolerance: +/- 0.2 mm Material magnet: Neodymium-NiCuNi plated</p>

<p><b>BMN-PP-32</b> deep pot magnet Ø 32 mm with stud stud Ø 10 mm Weight: 250 g strength: approx. 34 kg</p>	<p>Price in CHF</p> <p>1 pc. 7.90 ea. from 3 pcs. 7.05 ea. from 10 pcs. 6.20 ea. from 40 pcs. 5.45 ea. from 80 pcs. 5.10 ea.</p>	<p>Diameter D: 32 mm Height H1: 40 mm Height H2: 50 mm Diameter stud d: 10 mm Tolerance: +/- 0.2 mm Material magnet: Neodymium-NiCuNi plated</p>
<p><b>BMN-TS-10</b> deep pot magnet Ø 10 mm with threaded stud thread M4 Weight: 11 g strength: approx. 2.4 kg</p>	<p>Price in CHF</p> <p>5 pcs. 3.00 ea. from 15 pcs. 2.64 ea. from 40 pcs. 2.37 ea. from 120 pcs. 2.11 ea.</p>	<p>Diameter D: 10 mm Height H1: 20 mm Height H2: 28 mm Thread M: 4 Tolerance: +/- 0.2 mm Material magnet: Neodymium-NiCuNi plated</p>
<p><b>BMN-TS-13</b> deep pot magnet Ø 13 mm with threaded stud thread M4 Weight: 20 g strength: approx. 6 kg</p>	<p>Price in CHF</p> <p>5 pcs. 2.80 ea. from 15 pcs. 2.44 ea. from 40 pcs. 2.17 ea.</p>	<p>Diameter D: 13 mm Height H1: 20 mm Height H2: 28 mm Thread M: 4 Tolerance: +/- 0.2 mm Material magnet: Neodymium-NiCuNi plated</p>
<p><b>BMN-TS-16</b> deep pot magnet Ø 16 mm with threaded stud thread M4 Weight: 30 g strength: approx. 9 kg</p>	<p>Price in CHF</p> <p>1 pc. 3.60 ea. from 3 pcs. 3.15 ea. from 10 pcs. 2.70 ea. from 40 pcs. 2.30 ea. from 80 pcs. 2.15 ea.</p>	<p>Diameter D: 16 mm Height H1: 20 mm Height H2: 30 mm Thread M: 4 Tolerance: +/- 0.2 mm Material magnet: Neodymium-NiCuNi plated</p>
<p><b>BMN-TS-20</b> deep pot magnet Ø 20 mm with threaded stud thread M6 Weight: 58 g strength: approx. 13 kg</p>	<p>Price in CHF</p> <p>1 pc. 4.10 ea. from 3 pcs. 3.55 ea. from 10 pcs. 3.10 ea. from 40 pcs. 2.65 ea. from 80 pcs. 2.45 ea.</p>	<p>Diameter D: 20 mm Height H1: 25 mm Height H2: 35 mm Thread M: 6 Tolerance: +/- 0.2 mm Material magnet: Neodymium-NiCuNi plated</p>
<p><b>BMN-TS-25</b> deep pot magnet Ø 25 mm with threaded stud thread M6 Weight: 130 g strength: approx. 19 kg</p>	<p>Price in CHF</p> <p>1 pc. 5.35 ea. from 3 pcs. 4.70 ea. from 10 pcs. 4.10 ea. from 40 pcs. 3.55 ea. from 80 pcs. 3.30 ea.</p>	<p>Diameter D: 25 mm Height H1: 35 mm Height H2: 45 mm Thread M: 6 Tolerance: +/- 0.2 mm Material magnet: Neodymium-NiCuNi plated</p>
<p><b>BMN-TS-32</b> deep pot magnet Ø 32 mm with threaded stud thread M8 Weight: 240 g strength: approx. 34 kg</p>	<p>Price in CHF</p> <p>1 pc. 7.90 ea. from 3 pcs. 7.00 ea. from 10 pcs. 6.15 ea. from 40 pcs. 5.40 ea.</p>	<p>Diameter D: 32 mm Height H1: 40 mm Height H2: 52 mm Thread M: 8 Tolerance: +/- 0.2 mm Material magnet: Neodymium-NiCuNi plated</p>



## Nuts & Bolts

<p><b>M-HN-A2M4</b> Hex nut M4 made of stainless steel A2 100 pieces per package Weight: 69 g/set</p>	<p>Price in CHF 1 set 5.15/set</p>	<p>These hexagonal nuts with M4 thread are made of stainless steel type A2 and conform to standard DIN 934. The nuts with strength class 70 are shipped in small boxes of 100 pieces each.</p>
<p><b>M-HN-A2M5</b> Hex nut M5 made of stainless steel A2 100 pieces per package Weight: 110 g/set</p>	<p>Price in CHF 1 set 6.05/set</p>	<p>These hexagonal nuts with M5 thread are made of stainless steel type A2 and conform to standard DIN 934. The nuts with strength class 70 are shipped in small boxes of 100 pieces each.</p>
<p><b>M-HN-A2M6</b> Hex nut M6 made of stainless steel A2 100 pieces per package Weight: 220 g/set</p>	<p>Price in CHF 1 set 9.10/set</p>	<p>These hexagonal nuts with M6 thread are made of stainless steel type A2 and conform to standard DIN 934. The nuts with strength class 70 are shipped in small boxes of 100 pieces each.</p>
<p><b>M-HN-A2M8</b> Hex nut M8 made of stainless steel A2 100 pieces per package Weight: 470 g/set</p>	<p>Price in CHF 1 set 15.25/set</p>	<p>These hexagonal nuts with M8 thread are made of stainless steel type A2 and conform to standard DIN 934. The nuts with strength class 70 are shipped in small boxes of 100 pieces each.</p>
<p><b>M-RB-M6</b> Eyebolt M6 made of steel C15 zinc-plated Weight: 58 g</p>	<p>Price in CHF 1 pc. 2.50 ea.</p>	<p>Eyebolt with M6 thread made of galvanised steel and with a right-angle tensile strength of 80 kg. The perfect accessory for our pot magnets with screw sockets.</p>
<p><b>M-RB-M8</b> Eyebolt M8 made of steel C15 zinc-plated Weight: 58 g</p>	<p>Price in CHF 1 pc. 2.50 ea.</p>	<p>Eyebolt with M8 thread made of galvanised steel and with a right-angle tensile strength of 140 kg. The perfect accessory for our pot magnets with screw sockets.</p>
<p><b>M-RN-M6</b> Ring nut M6 made of steel C15 zinc-plated Weight: 50 g</p>	<p>Price in CHF 1 pc. 2.50 ea.</p>	<p>Ring nut with M6 thread made of galvanised steel and with a right-angle tensile strength of 80 kg. The perfect accessory for our pot magnets with threaded studs.</p>
<p><b>M-RN-M8</b> Ring nut M8 made of steel C15 zinc-plated Weight: 52 g</p>	<p>Price in CHF 1 pc. 2.50 ea.</p>	<p>Ring nut with M8 thread made of galvanised steel and with a right-angle tensile strength of 140 kg. The perfect accessory for our pot magnets with threaded studs.</p>

**M-TN-10M8**

T-nut M8  
nut for T-slots, slot nominal  
dimension 10 mm  
black  
Weight: 12 g

Price in CHF  
1 pc. 4.95 ea.

These black T-nuts with M8 thread are made of heat-treated steel (class 10) and conform to DIN standard 508 extended.

## Plastic handles / grips

<p><b>M-PAH-EM5</b> Plastic handle with threaded stud M5 black Weight: 13 g</p>	<p>Price in CHF 1 pc. 4.95 ea. from 3 pcs. 4.75 ea. from 10 pcs. 4.50 ea.</p>	<p>This tapered plastic handle with galvanised threaded stud M5 is the perfect accessory for our pot magnets with internal thread. You can find links to matching magnets on our website.</p>
<p><b>M-PAH-EM6</b> Plastic handle with threaded stud M6 black Weight: 31 g</p>	<p>Price in CHF 1 pc. 5.40 ea. from 3 pcs. 4.90 ea. from 10 pcs. 4.10 ea.</p>	<p>This tapered plastic handle with galvanised threaded stud M6 is the perfect accessory for our pot magnets with internal thread. You can find links to matching magnets on our website.</p>
<p><b>M-PAH-EM8</b> Plastic handle with threaded stud M8 black Weight: 35 g</p>	<p>Price in CHF 1 pc. 5.90 ea. from 3 pcs. 5.60 ea. from 10 pcs. 4.90 ea.</p>	<p>This tapered plastic handle with galvanised threaded stud M8 is the perfect accessory for our pot magnets with internal thread. You can find links to matching magnets on our website.</p>
<p><b>M-PAH-IM5</b> Plastic handle with internal thread M5 black Weight: 7 g</p>	<p>Price in CHF 1 pc. 4.45 ea. from 3 pcs. 4.05 ea. from 10 pcs. 3.65 ea.</p>	<p>This small tapered plastic handle with internal thread M5 is the perfect accessory for our pot magnets with threaded stud. You can find links to matching magnets on our website.</p>
<p><b>M-PAH-IM6</b> Plastic handle with internal thread M6 Black Weight: 10 g</p>	<p>Price in CHF 1 pc. 5.90 ea. from 3 pcs. 5.40 ea. from 10 pcs. 4.90 ea.</p>	<p>Glossy black plastic handle with internal thread M6 and slightly rounded ends. You can find links to matching pot magnets on our website.</p>
<p><b>M-PAH-IM8</b> Plastic handle with internal thread M8 black Weight: 18 g</p>	<p>Price in CHF 1 pc. 8.90 ea. from 3 pcs. 8.10 ea. from 10 pcs. 7.50 ea.</p>	<p>Glossy black plastic handle with internal thread M8 and slightly rounded ends. You can find links to matching pot magnets on our website.</p>

## Screw-on metal plates & metal discs with a hole

These are not magnets! These metal discs are suitable as counterparts for our magnets, e.g. hook or block magnets with hole.

They can be easily screwed onto non-magnetic surfaces with a countersunk bolt.

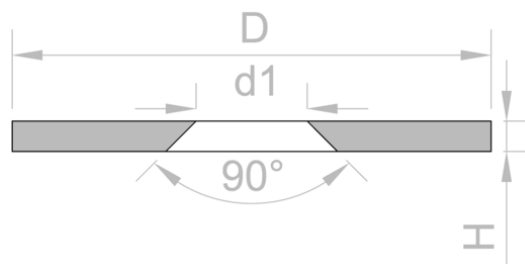

© supermagnete.com

<p><b>MSD-17</b> Metal disc with an edge and countersunk hole M3 Inner diameter 17 mm as a counterpart to magnets, not a magnet! Weight: 4 g</p>	<p>Price in CHF</p> <p>10 pcs. 1.15 ea. from 20 pcs. 1.05 ea. from 40 pcs. 1.00 ea.</p>	<p>These metal discs with an edge and countersunk hole are perfect magnetic bases for our pot magnets or magnetic hooks.</p>
<p><b>MSD-21</b> Metal disc with an edge and countersunk hole M3 Inner diameter 21 mm as a counterpart to magnets, not a magnet! Weight: 5.5 g</p>	<p>Price in CHF</p> <p>10 pcs. 1.25 ea. from 20 pcs. 1.15 ea. from 40 pcs. 1.10 ea.</p>	<p>These metal discs with an edge and countersunk hole are perfect magnetic bases for our pot magnets or magnetic hooks.</p>
<p><b>MSD-26</b> Metal disc with an edge and countersunk hole M4 Inner diameter 26 mm as a counterpart to magnets, not a magnet! Weight: 13 g</p>	<p>Price in CHF</p> <p>10 pcs. 1.30 ea. from 20 pcs. 1.25 ea. from 40 pcs. 1.20 ea.</p>	<p>These metal discs with an edge and countersunk hole are perfect magnetic bases for our pot magnets or magnetic hooks.</p>
<p><b>MSD-33</b> Metal disc with an edge and countersunk hole M4 Inner diameter 33 mm as a counterpart to magnets, not a magnet! Weight: 19 g</p>	<p>Price in CHF</p> <p>10 pcs. 1.40 ea. from 20 pcs. 1.35 ea. from 40 pcs. 1.30 ea.</p>	<p>These metal discs with an edge and countersunk hole are perfect magnetic bases for our pot magnets or magnetic hooks.</p>
<p><b>MD-12</b> Metal disc with countersunk hole Ø 12 mm as a counterpart to magnets not a magnet! Weight: 0.5 g</p>	<p>Price in CHF</p> <p>10 pcs. 0.20 ea. from 40 pcs. 0.16 ea. from 80 pcs. 0.15 ea. from 160 pcs. 0.13 ea.</p>	<p>Diameter D: 12 mm Height H: 1.5 mm Hole d1: 5.5 mm Hole d2: 8.5 mm Coating: Nickel (Ni)</p>
<p><b>MD-15</b> Metal disc with countersunk hole Ø 15 mm as a counterpart to magnets not a magnet! Weight: 1.2 g</p>	<p>Price in CHF</p> <p>10 pcs. 0.24 ea. from 40 pcs. 0.20 ea. from 80 pcs. 0.18 ea. from 160 pcs. 0.17 ea.</p>	<p>Diameter D: 15 mm Height H: 1.5 mm Hole d1: 5.5 mm Hole d2: 8.5 mm Coating: Nickel (Ni)</p>

<p><b>MD-18</b> Metal disc with countersunk hole Ø 18 mm as a counterpart to magnets not a magnet! Weight: 2.5 g</p>	<p>Price in CHF</p> <p>10 pcs. 0.24 ea. from 40 pcs. 0.20 ea. from 80 pcs. 0.19 ea. from 160 pcs. 0.17 ea.</p>	<p>Diameter D: 18 mm Height H: 1.5 mm Hole d1: 5.5 mm Hole d2: 8.5 mm Coating: Nickel (Ni)</p>
<p><b>MD-23</b> Metal disc with countersunk hole Ø 23 mm as a counterpart to magnets not a magnet! Weight: 4 g</p>	<p>Price in CHF</p> <p>10 pcs. 0.32 ea. from 40 pcs. 0.27 ea. from 80 pcs. 0.25 ea. from 160 pcs. 0.24 ea.</p>	<p>Diameter D: 23 mm Height H: 1.5 mm Hole d1: 5.5 mm Hole d2: 8.5 mm Coating: Nickel (Ni)</p>
<p><b>MD-27</b> Metal disc with countersunk hole Ø 27 mm as a counterpart to magnets not a magnet! Weight: 12 g</p>	<p>Price in CHF</p> <p>10 pcs. 0.38 ea. from 40 pcs. 0.33 ea. from 80 pcs. 0.31 ea. from 160 pcs. 0.29 ea.</p>	<p>Diameter D: 27 mm Height H: 3 mm Hole d1: 5.7 mm Hole d2: 11.7 mm Coating: Nickel (Ni)</p>
<p><b>MD-34</b> Metal disc with countersunk hole Ø 34 mm as a counterpart to magnets not a magnet! Weight: 19 g</p>	<p>Price in CHF</p> <p>10 pcs. 0.46 ea. 20 pcs. 0.41 ea. 30 pcs. 0.37 ea. from 40 pcs. 0.35 ea.</p>	<p>Diameter D: 34 mm Height H: 3 mm Hole d1: 5.7 mm Hole d2: 11.7 mm Coating: Nickel (Ni)</p>
<p><b>MD-42</b> Metal disc with countersunk hole Ø 42 mm as a counterpart to magnets not a magnet! Weight: 31 g</p>	<p>Price in CHF</p> <p>5 pcs. 0.60 ea. from 15 pcs. 0.54 ea. from 40 pcs. 0.50 ea. from 80 pcs. 0.47 ea.</p>	<p>Diameter D: 42 mm Height H: 3 mm Hole d1: 5.7 mm Hole d2: 11.7 mm Coating: Nickel (Ni)</p>
<p><b>MD-50</b> Metal disc with countersunk hole Ø 50 mm as a counterpart to magnets not a magnet! Weight: 44 g</p>	<p>Price in CHF</p> <p>5 pcs. 0.65 ea. from 15 pcs. 0.58 ea. from 40 pcs. 0.53 ea. from 80 pcs. 0.51 ea.</p>	<p>Diameter D: 50 mm Height H: 3 mm Hole d1: 5.7 mm Hole d2: 11.7 mm Coating: Nickel (Ni)</p>
<p><b>MD-52</b> Metal disc with countersunk hole Ø 52 mm as a counterpart to magnets not a magnet! Weight: 49 g</p>	<p>Price in CHF</p> <p>5 pcs. 0.72 ea. from 15 pcs. 0.65 ea. from 40 pcs. 0.60 ea. from 80 pcs. 0.57 ea.</p>	<p>Diameter D: 52 mm Height H: 3 mm Hole d1: 5.7 mm Hole d2: 11.7 mm Coating: Nickel (Ni)</p>
<p><b>MD-62</b> Metal disc with countersunk hole Ø 62 mm as a counterpart to magnets not a magnet! Weight: 69 g</p>	<p>Price in CHF</p> <p>5 pcs. 1.10 ea. from 15 pcs. 1.01 ea. from 40 pcs. 0.95 ea. from 80 pcs. 0.91 ea.</p>	<p>Diameter D: 62 mm Height H: 3 mm Hole d1: 5.7 mm Hole d2: 11.7 mm Coating: Nickel (Ni)</p>
<p><b>MD-65</b> Metal disc with countersunk hole Ø 65 mm as a counterpart to magnets not a magnet! Weight: 76 g</p>	<p>Price in CHF</p> <p>5 pcs. 1.14 ea. from 15 pcs. 1.02 ea. from 40 pcs. 0.93 ea. from 80 pcs. 0.88 ea.</p>	<p>Diameter D: 65 mm Height H: 3 mm Hole d1: 5.7 mm Hole d2: 11.7 mm Coating: Nickel (Ni)</p>

<p><b>MC-12-12-03</b> Metal plate with countersunk hole 12 x 12 x 3 mm as a counterpart to magnets not a magnet! Weight: 2 g</p>	<p>Price in CHF</p> <p>10 pcs. 0.22 ea. from 40 pcs. 0.21 ea. from 160 pcs. 0.20 ea.</p>	<p>These metal plates are the ideal base for countersunk block magnets. They can be easily screwed onto non-magnetic surfaces with a countersunk head-screw.</p>
<p><b>MC-15-15-03</b> Metal plate with countersunk hole 15 x 15 x 3 mm as a counterpart to magnets not a magnet! Weight: 3.9 g</p>	<p>Price in CHF</p> <p>10 pcs. 0.26 ea. from 40 pcs. 0.22 ea. from 80 pcs. 0.20 ea. from 160 pcs. 0.18 ea.</p>	<p>These metal plates are the ideal base for countersunk block magnets. They can be easily screwed onto non-magnetic surfaces with a countersunk head-screw.</p>
<p><b>MC-100-20-03</b> Metal plate with two countersunk holes 100 x 20 x 3 mm as a counterpart to magnets not a magnet! Weight: 43 g</p>	<p>Price in CHF</p> <p>10 pcs. 1.08 ea. from 20 pcs. 0.96 ea. from 40 pcs. 0.87 ea. from 80 pcs. 0.81 ea.</p>	<p>These metal plates are the ideal base for countersunk block magnets. They can be easily screwed onto non-magnetic surfaces with a countersunk head-screw.</p>
<p><b>MC-120-20-03</b> Metal plate with two countersunk holes 120 x 20 x 3 mm as a counterpart to magnets not a magnet! Weight: 53 g</p>	<p>Price in CHF</p> <p>5 pcs. 1.31 ea. from 15 pcs. 1.17 ea. from 40 pcs. 1.07 ea. from 80 pcs. 1.00 ea.</p>	<p>These metal plates are the ideal base for countersunk block magnets. They can be easily screwed onto non-magnetic surfaces with a countersunk head-screw.</p>
<p><b>MC-20-12-03</b> Metal plate with countersunk hole 20 x 12 x 3 mm as a counterpart to magnets not a magnet! Weight: 4 g</p>	<p>Price in CHF</p> <p>10 pcs. 0.34 ea. from 40 pcs. 0.30 ea. from 80 pcs. 0.28 ea. from 160 pcs. 0.26 ea.</p>	<p>These metal plates are the ideal base for countersunk block magnets. They can be easily screwed onto non-magnetic surfaces with a countersunk head-screw.</p>
<p><b>MC-20-20-03</b> Metal plate with countersunk hole 20 x 20 x 3 mm as a counterpart to magnets not a magnet! Weight: 8 g</p>	<p>Price in CHF</p> <p>10 pcs. 0.39 ea. from 40 pcs. 0.34 ea. from 80 pcs. 0.32 ea. from 160 pcs. 0.30 ea.</p>	<p>These metal plates are the ideal base for countersunk block magnets. They can be easily screwed onto non-magnetic surfaces with a countersunk head-screw.</p>
<p><b>MC-25-13-03</b> Metal plate with countersunk hole 25 x 13 x 3 mm as a counterpart to magnets not a magnet! Weight: 6 g</p>	<p>Price in CHF</p> <p>10 pcs. 0.35 ea. from 40 pcs. 0.31 ea. from 80 pcs. 0.29 ea. from 160 pcs. 0.27 ea.</p>	<p>These metal plates are the ideal base for countersunk block magnets. They can be easily screwed onto non-magnetic surfaces with a countersunk head-screw.</p>
<p><b>MC-30-12-03</b> Metal plate with countersunk hole 30 x 12 x 3 mm as a counterpart to magnets not a magnet! Weight: 7 g</p>	<p>Price in CHF</p> <p>10 pcs. 0.38 ea. from 40 pcs. 0.33 ea. from 80 pcs. 0.31 ea. from 160 pcs. 0.29 ea.</p>	<p>These metal plates are the ideal base for countersunk block magnets. They can be easily screwed onto non-magnetic surfaces with a countersunk head-screw.</p>
<p><b>MC-40-20-03</b> Metal plate with two countersunk holes 40 x 20 x 3 mm as a counterpart to magnets not a magnet! Weight: 16 g</p>	<p>Price in CHF</p> <p>5 pcs. 0.48 ea. from 15 pcs. 0.43 ea. from 40 pcs. 0.39 ea. from 80 pcs. 0.37 ea.</p>	<p>These metal plates are the ideal base for countersunk block magnets. They can be easily screwed onto non-magnetic surfaces with two countersunk head-screws.</p>

<b>MC-40-40-03</b> Metal plate with two countersunk holes 40 x 40 x 3 mm as a counterpart to magnets not a magnet! Weight: 35 g	Price in CHF 5 pcs. 0.50 ea. from 15 pcs. 0.44 ea. from 40 pcs. 0.40 ea. from 80 pcs. 0.37 ea.	These metal plates are the ideal base for countersunk block magnets. They can be easily screwed onto non- magnetic surfaces with two countersunk head-screws.
<b>MC-60-20-03</b> Metal plate with two countersunk holes 60 x 20 x 3 mm as a counterpart to magnets not a magnet! Weight: 25 g	Price in CHF 5 pcs. 0.77 ea. from 15 pcs. 0.70 ea. from 40 pcs. 0.64 ea. from 80 pcs. 0.61 ea.	These metal plates are the ideal base for countersunk block magnets. They can be easily screwed onto non- magnetic surfaces with two countersunk head-screws.
<b>MC-80-20-03</b> Metal plate with two countersunk holes 80 x 20 x 3 mm as a counterpart to magnets not a magnet! Weight: 35 g	Price in CHF 5 pcs. 0.87 ea. from 15 pcs. 0.79 ea. from 40 pcs. 0.74 ea. from 80 pcs. 0.70 ea.	These metal plates are the ideal base for countersunk block magnets. They can be easily screwed onto non- magnetic surfaces with two countersunk head-screws.

## Self-adhesive metal discs: ideal counterparts for magnets

These metal discs are suitable as counterpart for our magnets, e.g. disc or hook magnets. Thanks to the self-adhesive back, they can be easily attached to smooth surfaces.

<p><b>PAS-10</b> Metal disc self-adhesive Ø 10 mm as a counterpart to magnets not a magnet! Weight: 1.2 g</p>	<p>Price in CHF</p> <p>10 pcs. 0.24 ea. from 40 pcs. 0.20 ea. from 80 pcs. 0.19 ea. from 160 pcs. 0.17 ea.</p>	<p>Diameter D: 10 mm Height H: 2 mm Steel: Q235 (China) Coating: Zinc (Zn) Tolerance: +/- 0.1 mm Adhesive: 3M, No. 9888T</p>
<p><b>PAS-10-W</b> Metal disc self-adhesive white Ø 10 mm as a counterpart to magnets not a magnet! Weight: 1.3 g</p>	<p>Price in CHF</p> <p>10 pcs. 0.28 ea. from 40 pcs. 0.24 ea. from 80 pcs. 0.22 ea. from 160 pcs. 0.20 ea.</p>	<p>Diameter D: 10.3 mm Height H: 2.3 mm Steel: Q235 (China) Coating: Zinc (Zn), spray-painted Tolerance: +/- 0.2 mm Adhesive: 3M, No. 9888T</p>
<p><b>PAS-13</b> Metal disc self-adhesive Ø 13 mm as a counterpart to magnets not a magnet! Weight: 2.1 g</p>	<p>Price in CHF</p> <p>10 pcs. 0.25 ea. from 40 pcs. 0.21 ea. from 80 pcs. 0.20 ea. from 160 pcs. 0.18 ea.</p>	<p>Diameter D: 13 mm Height H: 2 mm Steel: Q235 (China) Coating: Zinc (Zn) Tolerance: +/- 0.1 mm Adhesive: 3M, No. 9888T</p>
<p><b>PAS-13-W</b> Metal disc self-adhesive white Ø 13 mm as a counterpart to magnets not a magnet! Weight: 2.2 g</p>	<p>Price in CHF</p> <p>10 pcs. 0.29 ea. from 40 pcs. 0.25 ea. from 80 pcs. 0.23 ea. from 160 pcs. 0.22 ea.</p>	<p>Diameter D: 13.3 mm Height H: 2.3 mm Steel: Q235 (China) Coating: Zinc (Zn), spray-painted Tolerance: +/- 0.2 mm Adhesive: 3M, No. 9888T</p>
<p><b>PAS-16</b> Metal disc self-adhesive Ø 16 mm as a counterpart to magnets not a magnet! Weight: 3.2 g</p>	<p>Price in CHF</p> <p>10 pcs. 0.27 ea. from 40 pcs. 0.22 ea. from 80 pcs. 0.21 ea. from 160 pcs. 0.19 ea.</p>	<p>Diameter D: 16 mm Height H: 2 mm Steel: Q235 (China) Coating: Zinc (Zn) Tolerance: +/- 0.1 mm Adhesive: 3M, No. 9888T</p>
<p><b>PAS-16-W</b> Metal disc self-adhesive white Ø 16 mm as a counterpart to magnets not a magnet! Weight: 3.3 g</p>	<p>Price in CHF</p> <p>10 pcs. 0.32 ea. from 40 pcs. 0.28 ea. from 80 pcs. 0.26 ea. from 160 pcs. 0.24 ea.</p>	<p>Diameter D: 16.3 mm Height H: 2.3 mm Steel: Q235 (China) Coating: Zinc (Zn), spray-painted Tolerance: +/- 0.2 mm Adhesive: 3M, No. 9888T</p>
<p><b>PAS-20</b> Metal disc self-adhesive Ø 20 mm as a counterpart to magnets not a magnet! Weight: 5 g</p>	<p>Price in CHF</p> <p>10 pcs. 0.28 ea. from 40 pcs. 0.23 ea. from 80 pcs. 0.22 ea. from 160 pcs. 0.20 ea.</p>	<p>Diameter D: 20 mm Height H: 2 mm Steel: Q235 (China) Coating: Zinc (Zn) Tolerance: +/- 0.1 mm Adhesive: 3M, No. 9888T</p>
<p><b>PAS-20-W</b> Metal disc self-adhesive white Ø 20 mm as a counterpart to magnets not a magnet! Weight: 5.1 g</p>	<p>Price in CHF</p> <p>10 pcs. 0.34 ea. from 40 pcs. 0.29 ea. from 80 pcs. 0.27 ea. from 160 pcs. 0.25 ea.</p>	<p>Diameter D: 20.3 mm Height H: 2.3 mm Steel: Q235 (China) Coating: Zinc (Zn), spray-painted Tolerance: +/- 0.2 mm Adhesive: 3M, No. 9888T</p>



## Rubber caps & self-adhesive rubber discs: Skid and scratch protection all in one

These rubber caps can be put over the bottom side of pot magnets to protect delicate surfaces, plus the friction increases the load capacity of the magnet in shear direction.

<p><b>M-SIL-10</b> Rubber discs self-adhesive Ø 10 mm to protect surfaces 136 per set Weight: 25 g/set</p>	<p>Price in CHF</p> <p>1 set 4.15/set</p> <p>from 3 sets 3.80/set</p> <p>from 10 sets 3.45/set</p> <p>from 20 sets 3.30/set</p> <p>from 40 sets 3.15/set</p>	<p>Material: Silicone Diameter: 10 mm Thickness: 0.5 mm Pieces per sheet: 136 pieces Adhesive: 3M, No. 9080A Shelf life adhesive: 24 months (approx.)</p>
<p><b>M-SIL-12</b> Rubber discs self-adhesive Ø 12 mm to protect surfaces 98 per set Weight: 25 g/set</p>	<p>Price in CHF</p> <p>1 set 3.90/set</p>	<p>Material: Silicone Diameter: 12 mm Thickness: 0.5 mm Pieces per sheet: 98 pieces Adhesive: 3M, No. 9080A Shelf life adhesive: 24 months (approx.)</p>
<p><b>M-SIL-15</b> Rubber discs self-adhesive Ø 15 mm to protect surfaces 60 per set Weight: 25 g/set</p>	<p>Price in CHF</p> <p>1 set 3.45/set</p>	<p>Material: Silicone Diameter: 15 mm Thickness: 0.5 mm Pieces per sheet: 60 pieces Adhesive: 3M, No. 9080A Shelf life adhesive: 24 months (approx.)</p>
<p><b>M-SIL-20</b> Rubber discs self-adhesive Ø 20 mm to protect surfaces 36 per set Weight: 25 g/set</p>	<p>Price in CHF</p> <p>1 set 3.50/set</p>	<p>Material: Silicone Diameter: 20 mm Thickness: 0.5 mm Pieces per sheet: 36 pieces Adhesive: 3M, No. 9080A Shelf life adhesive: 24 months (approx.)</p>
<p><b>PAR-11</b> Rubber caps Ø 11 mm to protect surfaces Weight: 0.16 g</p>	<p>Price in CHF</p> <p>10 pcs. 0.17 ea.</p> <p>from 40 pcs. 0.14 ea.</p> <p>from 80 pcs. 0.13 ea.</p> <p>from 160 pcs. 0.12 ea.</p>	<p>Diameter D: 11 mm Height H: 3 mm Material strength t: 0.5 mm Max. working temperature: 100°C</p>
<p><b>PAR-14</b> Rubber caps Ø 14 mm to protect surfaces Weight: 0.2 g</p>	<p>Price in CHF</p> <p>10 pcs. 0.19 ea.</p> <p>from 40 pcs. 0.15 ea.</p> <p>from 80 pcs. 0.14 ea.</p> <p>from 160 pcs. 0.13 ea.</p>	<p>Diameter D: 14 mm Height H: 3 mm Material strength t: 0.5 mm Max. working temperature: 100°C</p>
<p><b>PAR-17</b> Rubber caps Ø 17 mm to protect surfaces Weight: 0.3 g</p>	<p>Price in CHF</p> <p>10 pcs. 0.21 ea.</p> <p>from 40 pcs. 0.19 ea.</p> <p>from 80 pcs. 0.17 ea.</p> <p>from 160 pcs. 0.16 ea.</p>	<p>Diameter D: 17 mm Height H: 3 mm Material strength t: 0.5 mm Max. working temperature: 100°C</p>
<p><b>PAR-21</b> Rubber caps Ø 21 mm to protect surfaces Weight: 0.5 g</p>	<p>Price in CHF</p> <p>10 pcs. 0.22 ea.</p> <p>from 40 pcs. 0.18 ea.</p> <p>from 80 pcs. 0.17 ea.</p> <p>from 160 pcs. 0.15 ea.</p>	<p>Diameter D: 21 mm Height H: 5 mm Material strength t: 0.5 mm Max. working temperature: 100°C</p>

<p><b>PAR-26</b> Rubber caps Ø 26 mm to protect surfaces Weight: 0.7 g</p>	<p>Price in CHF 10 pcs. 0.23 ea. from 40 pcs. 0.19 ea. from 80 pcs. 0.17 ea. from 160 pcs. 0.15 ea.</p>	<p>Diameter D: 26 mm Height H: 5 mm Material strength t: 0.5 mm Max. working temperature: 100°C</p>
<p><b>PAR-33</b> Rubber caps Ø 33 mm to protect surfaces Weight: 1 g</p>	<p>Price in CHF 5 pcs. 0.27 ea. from 15 pcs. 0.23 ea. from 40 pcs. 0.21 ea. from 80 pcs. 0.19 ea.</p>	<p>Diameter D: 33 mm Height H: 5 mm Material strength t: 0.5 mm Max. working temperature: 100°C</p>
<p><b>PAR-41</b> Rubber caps Ø 41 mm to protect surfaces Weight: 1.6 g</p>	<p>Price in CHF 5 pcs. 0.29 ea. from 15 pcs. 0.25 ea. from 40 pcs. 0.23 ea. from 80 pcs. 0.21 ea.</p>	<p>Diameter D: 41 mm Height H: 6 mm Material strength t: 0.5 mm</p>
<p><b>PAR-49</b> Rubber caps Ø 49 mm to protect surfaces Weight: 2 g</p>	<p>Price in CHF 5 pcs. 0.34 ea. from 15 pcs. 0.30 ea. from 40 pcs. 0.28 ea. from 80 pcs. 0.26 ea.</p>	<p>Diameter D: 49 mm Height H: 6 mm Material strength t: 0.5 mm Max. working temperature: 100°C</p>
<p><b>PAR-51</b> Rubber caps Ø 51 mm to protect surfaces Weight: 2.2 g</p>	<p>Price in CHF 5 pcs. 0.35 ea. from 15 pcs. 0.31 ea. from 40 pcs. 0.29 ea. from 80 pcs. 0.27 ea.</p>	<p>Diameter D: 51 mm Height H: 6 mm Material strength t: 0.5 mm Max. working temperature: 100°C</p>
<p><b>PAR-61</b> Rubber caps Ø 61 mm to protect surfaces Weight: 3 g</p>	<p>Price in CHF 5 pcs. 0.37 ea. from 15 pcs. 0.33 ea. from 40 pcs. 0.30 ea. from 80 pcs. 0.28 ea.</p>	<p>Diameter D: 61 mm Height H: 6 mm Material strength t: 0.5 mm Max. working temperature: 100°C</p>
<p><b>PAR-64</b> Rubber caps Ø 64 mm to protect surfaces Weight: 3.5 g</p>	<p>Price in CHF 5 pcs. 0.40 ea. from 15 pcs. 0.36 ea. from 40 pcs. 0.33 ea. from 80 pcs. 0.31 ea.</p>	<p>Diameter D: 64 mm Height H: 6 mm Material strength t: 0.5 mm Max. working temperature: 100°C</p>
<p><b>PAR-76</b> Rubber caps Ø 76 mm to protect surfaces Weight: 3 g</p>	<p>Price in CHF 5 pcs. 0.41 ea. from 15 pcs. 0.39 ea. from 40 pcs. 0.37 ea. from 80 pcs. 0.36 ea.</p>	<p>Diameter D: 76 mm Height H: 6 mm Material strength t: 0.5 mm Max. working temperature: 100°C</p>

## Practical magnetic accessories for the warehouse

<b>WS-LHM-125</b> Lifting magnet MaxX 125 maximum load 125 kg for flat and round stock safety factor 3:1 Weight: 3.7 kg	Price in CHF 1 pc. 439.00 ea.	The lifting magnet MaxX 125 features a rotating hook and can hold loads of up to 125 kg. Detailed specifications and safety tips can be found in our online shop.
<b>WS-LHM-250</b> Lifting magnet MaxX 250 maximum load 250 kg for flat and round stock Safety factor 3:1 Weight: 6 kg	Price in CHF 1 pc. 529.00 ea.	The lifting magnet MaxX 250 features a fixed hook and can hold loads of up to 250 kg. Detailed specifications and safety tips can be found in our online shop.
<b>WS-LHM-300E</b> Lifting magnet MaxX 300E maximum load 300 kg for flat and round stock Safety factor 3:1 Weight: 6 kg	Price in CHF 1 pc. 535.50 ea.	The lifting magnet MaxX 300E features a fixed hook and can hold loads of up to 300 kg. Detailed specifications and safety tips can be found in our online shop.
<b>WS-LHM-500</b> Lifting magnet MaxX 500 maximum load 500 kg for flat and round stock Safety factor 3:1 Weight: 15 kg	Price in CHF 1 pc. 754.00 ea.	The lifting magnet MaxX 500 features a rotating hook and can hold loads of up to 500 kg. You can find detailed specifications and safety tips in our online shop.

## Magnets for POS and exhibition stand construction

<p><b>SF-ACC-01</b> Plastic profile for magnetic boot system transparent Weight: 10 g</p>	<p>Price in CHF 10 pcs. 1.00 ea. from 20 pcs. 0.85 ea. from 40 pcs. 0.80 ea. from 80 pcs. 0.75 ea.</p>	<p>Length: 350 mm Width: 16.2 mm Height: 10.3 Material: transparent plastic</p>
<p><b>SF-FRM-A3</b> Sign frame A3 made of plastic with rounded corners, U- pocket included in different colours Weight: 150 g</p>	<p>Price in CHF 5 pcs. 2.50 ea. from 15 pcs. 2.28 ea. from 40 pcs. 2.11 ea. from 80 pcs. 2.01 ea.</p>	<p>Practical sign frame in A3 format, made of sturdy plastic and available in various colours. U-shaped pocket inside made of hard PVC (not anti-reflective) is included.</p>
<p><b>SF-FRM-A4</b> Sign frame A4 made of plastic with rounded corners, U- pocket included in different colours Weight: 100 g</p>	<p>Price in CHF 5 pcs. 2.00 ea. from 15 pcs. 1.83 ea. from 40 pcs. 1.70 ea. from 80 pcs. 1.62 ea.</p>	<p>A practical sign frame in A4 format, made of sturdy plastic and available in various colours. U-shaped pocket inside made of hard PVC (not anti-reflective) is included.</p>
<p><b>SF-FRM-A5</b> Sign frame A5 made of plastic with rounded corners, U- pocket included in different colours Weight: 63 g</p>	<p>Price in CHF 5 pcs. 1.75 ea. from 15 pcs. 1.65 ea. from 40 pcs. 1.50 ea. from 80 pcs. 1.45 ea.</p>	<p>A practical sign frame in A5 format, made of sturdy plastic and available in various colours. U-shaped pocket inside made of hard PVC (not anti-reflective) is included.</p>
<p><b>SF-PFB-01</b> Closing clips for poster frames transparent</p>	<p>Price in CHF 10 pcs. 0.45 ea. from 50 pcs. 0.43 ea. from 100 pcs. 0.40 ea.</p>	<p>These sturdy closing clips made of clear plastic are the perfect accessory for our poster frames, preventing inserted posters from falling out.</p>
<p><b>SF-PFB-02</b> Clips for sign frames in different versions transparent Weight: 1 g</p>	<p>Price in CHF 10 pcs. 0.35 ea. from 50 pcs. 0.32 ea. from 100 pcs. 0.30 ea.</p>	<p>Width: 14 mm Depth: 8 mm Material: transparent plastic</p>

## Magnetic tape - for labelling, highlighting and marking

You can use these strong magnetised tapes (magnetic strips) in various widths and many different colours to label steel shelves and metal cupboards, etc. They are a colourful eye-catcher on a whiteboard or on magnetic paint. You can cut the tapes to the desired size with regular scissors, and they are easy to write and print on.

<p><b>MT-07</b> Coloured magnetic tape 7 mm magnetic strip for labelling and cutting rolls of 1 m Weight: 26 g/m</p>	<p>Price in CHF</p> <p>1 m 1.95/m from 3 m 1.65/m from 10 m 1.40/m from 20 m 1.25/m from 40 m 1.15/m</p>	<p>This magnetic tape is 7 mm wide and available in four different colours. It can easily be cut to the desired length with standard scissors and labelled. It will be delivered in strips of 1 m.</p>
<p><b>MT-10</b> Coloured magnetic tape 10 mm magnetic strip for labelling and cutting rolls of 1 m Weight: 37 g/m</p>	<p>Price in CHF</p> <p>1 m 1.90/m from 3 m 1.65/m from 10 m 1.40/m from 20 m 1.30/m from 40 m 1.20/m</p>	<p>The magnetic band MT-10 is 10 mm wide and available in many different colours. You can cut it to the desired size with regular scissors and write on it. The cut length is 1 metre.</p>
<p><b>MT-20</b> Coloured magnetic tape 20 mm magnetic strip for labelling and cutting rolls of 1 m Weight: 74 g/m</p>	<p>Price in CHF</p> <p>1 m 2.40/m from 3 m 2.05/m from 10 m 1.75/m from 20 m 1.60/m from 40 m 1.45/m</p>	<p>The magnetic band MT-20 is 20 mm wide and available in many different colours. You can cut it to the desired size with regular scissors and write on it. The cut length is 1 metre.</p>
<p><b>MT-30</b> Coloured magnetic tape 30 mm magnetic strip for labelling and cutting rolls of 1 m Weight: 110 g/m</p>	<p>Price in CHF</p> <p>1 m 3.10/m from 3 m 2.60/m from 10 m 2.20/m from 20 m 2.00/m from 40 m 1.85/m</p>	<p>The magnetic band MT-30 is 30 mm wide and available in many different colours. You can cut it to the desired size with regular scissors and write on it. The cut length is 1 metre.</p>
<p><b>MT-40</b> Coloured magnetic tape 40 mm magnetic strip for labelling and cutting rolls of 1 m Weight: 150 g/m</p>	<p>Price in CHF</p> <p>1 m 3.35/m from 3 m 2.90/m from 10 m 2.45/m from 20 m 2.25/m from 40 m 2.10/m</p>	<p>The magnetic band MT-40 is 40 mm wide and available in many different colours. You can cut it to the desired size with regular scissors and write on it. The cut length is 1 metre.</p>
<p><b>MT-150</b> Coloured magnetic tape 150 mm magnetic strip for labelling and cutting rolls of 1 m Weight: 560 g/m</p>	<p>Price in CHF</p> <p>1 m 8.95/m from 3 m 7.75/m from 10 m 6.65/m from 20 m 6.15/m from 40 m 5.65/m</p>	<p>The magnetic band MT-150 is 150 mm wide and available in many different colours. You can cut it to the desired size with regular scissors and write on it. The cut length is 1 metre.</p>

## Magnetic adhesive tape for flexible attachments

Self-adhesive magnetic tape can be used to inconspicuously attach non-magnetic objects (e.g. a plastic or aluminium sign) to metal surfaces. The self-adhesive strips also adhere to each other, so you can combine two non-magnetic objects. It's perfect for attaching flexible fly screens to windows and doors.

<p><b>MT-10-STIC</b> Magnetic adhesive tape ferrite 10 mm self-adhesive magnetic tape rolls of 1 m / 5 m / 25 m Weight: 56 g/m</p>	<p>Price in CHF</p> <p>1 m 1.88/m from 5 m 1.47/m from 25 m 1.16/m from 50 m 1.05/m from 75 m 0.99/m</p>	<p>The self-adhesive magnetic tape MT-10-STIC can attach non-magnetic objects to metal surfaces. This magnetic tape is 10 mm wide and available in lengths of 1 m, 5 m and 25 m.</p>
<p><b>MT-20-STIC</b> Magnetic adhesive tape ferrite 20 mm self-adhesive magnetic tape rolls of 1 m / 5 m / 25 m Weight: 110 g/m</p>	<p>Price in CHF</p> <p>1 m 2.49/m from 5 m 1.99/m from 25 m 1.62/m from 50 m 1.49/m from 75 m 1.42/m</p>	<p>The self-adhesive magnetic tape MT-20-STIC can attach non-magnetic objects to metal surfaces. This magnetic tape is 20 mm wide and available in lengths of 1 m, 5 m and 25 m.</p>
<p><b>MT-30-STIC</b> Magnetic adhesive tape ferrite 30 mm self-adhesive magnetic tape rolls of 1 m / 5 m / 25 m Weight: 170 g/m</p>	<p>Price in CHF</p> <p>1 m 2.86/m from 5 m 2.32/m from 25 m 1.90/m from 50 m 1.76/m from 75 m 1.68/m</p>	<p>The self-adhesive magnetic tape MT-30-STIC can attach non-magnetic objects to metal surfaces. This magnetic tape is 30 mm wide and available in lengths of 1 m, 5 m and 25 m.</p>
<p><b>MT-40-STIC</b> Magnetic adhesive tape ferrite 40 mm self-adhesive magnetic tape rolls of 1 m / 5 m / 25 m Weight: 220 g/m</p>	<p>Price in CHF</p> <p>1 m 3.40/m from 5 m 2.76/m from 25 m 2.27/m from 50 m 2.10/m from 75 m 2.01/m</p>	<p>The self-adhesive magnetic tape MT-40-STIC can attach non-magnetic objects to metal surfaces. This magnetic tape is 40 mm wide and available in lengths of 1 m, 5 m and 25 m.</p>
<p><b>MT-150-STIC</b> Magnetic adhesive tape ferrite 150 mm self-adhesive magnetic tape rolls of 1 m / 5 m / 25 m Weight: 920 g/m</p>	<p>Price in CHF</p> <p>1 m 9.13/m from 5 m 7.63/m from 25 m 6.50/m from 50 m 6.11/m from 75 m 5.90/m</p>	<p>The self-adhesive magnetic tape MT-150-STIC helps to attach non-magnetic objects on metal surfaces. This magnetic tape is 150 mm wide and available in lengths of 1 m, 5 m and 25 m.</p>
<p><b>MT-DISP</b> Magnetic adhesive tape for photos 5 m in dispenser Weight: 150 g</p>	<p>Price in CHF</p> <p>1 pc. 4.50 ea. from 3 pcs. 3.90 ea. from 10 pcs. 3.30 ea. from 20 pcs. 3.05 ea. from 40 pcs. 2.80 ea.</p>	<p>The tape that is both adhesive and magnetic. It attaches photos, postcards and other lightweight things easily and quickly to ferromagnetic surfaces, without making holes.</p>
<p><b>MT-DISP-R</b> Refill roll for magnetic adhesive tape dispenser magnetic adhesive tape 5 m Weight: 90 g</p>	<p>Price in CHF</p> <p>1 pc. 3.80 ea. from 3 pcs. 3.30 ea. from 10 pcs. 2.80 ea. from 20 pcs. 2.30 ea. from 40 pcs. 1.80 ea.</p>	<p>Use this practical refill once the original roll of MT-DISP magnetic adhesive tape has been used up.</p>
<p><b>NMT-10-STIC</b> Magnetic adhesive tape neodymium 10 mm self-adhesive magnetic tape extra-strong adhesive force rolls of 1 m Weight: 75 g/m</p>	<p>Price in CHF</p> <p>1 m 15.40/m from 3 m 13.75/m from 10 m 12.20/m from 20 m 11.50/m from 40 m 10.85/m</p>	<p>This self-adhesive magnetic tape (10 mm wide) features a phenomenal adhesive force of 450 g/cm<sup>2</sup> and is therefore 4x stronger than a regular magnetic tape.</p>

<b>NMT-20-STIC</b>			
Magnetic adhesive tape		Price in CHF	This self-adhesive magnetic tape (20 mm wide) features a phenomenal adhesive force of 450 g/cm <sup>2</sup> and is therefore 4x stronger than a regular magnetic tape.
neodymium 20 mm		1 m 27.85/m	
self-adhesive magnetic tape	from	3 m 24.95/m	
extra-strong adhesive force	from	10 m 22.35/m	
rolls of 1 m	from	20 m 21.10/m	
Weight: 150 g/m	from	40 m 20.00/m	
<b>NMT-30-STIC</b>			
Magnetic adhesive tape		Price in CHF	This self-adhesive magnetic tape (30 mm wide) features a phenomenal adhesive force of 450 g/cm <sup>2</sup> and is therefore 4x stronger than a regular magnetic tape.
neodymium 30 mm		1 m 38.50/m	
self-adhesive magnetic tape	from	3 m 34.55/m	
extra-strong adhesive force	from	10 m 31.00/m	
rolls of 1 m	from	20 m 29.25/m	
Weight: 230 g/m	from	40 m 27.75/m	

## Magnetic sheets for arts & crafts, highlighting and labelling

You can cut out colourful shapes from our magnetic sheets and attach them to whiteboards, for instance, as part of a presentation. Or you can use already punched-out coloured magnetic symbols. With our magnetic pocket you can protect and attach colour-coded statistics and process directives on iron surfaces.

<p><b>MS-W</b> Prohibition signs magnetic magnetic signs with various prohibition symbols Weight: 65 g</p>	<p>Price in CHF</p> <p>1 pc. 3.35 ea. from 3 pcs. 2.90 ea. from 10 pcs. 2.50 ea. from 20 pcs. 2.30 ea. from 40 pcs. 2.15 ea.</p>	<p>The big advantage of magnetic prohibition signs: They can be attached quickly to smooth ferromagnetic surfaces. Thanks to the flexible magnetic foil they can also be removed easily and without leaving a residue.</p>
<p><b>QMS-A4-STIC</b> Magnetic frame self-adhesive A4 magnetic pouch to display information A4 format in different colours Weight: 130 g</p>	<p>Price in CHF</p> <p>1 pc. 4.85 ea. from 3 pcs. 4.25 ea. from 10 pcs. 3.75 ea. from 20 pcs. 3.45 ea. from 40 pcs. 3.25 ea.</p>	<p>Self-adhesive magnetic frames in A4 format can be used on smooth, non-magnetic surfaces. Use them to quickly put up and change notices as needed.</p>
<p><b>QMS-A5-STIC</b> Magnetic frame self-adhesive A5 magnetic pouch to display information A5 format in different colours Weight: 92 g</p>	<p>Price in CHF</p> <p>1 pc. 3.80 ea. from 3 pcs. 3.25 ea. from 10 pcs. 2.80 ea. from 20 pcs. 2.60 ea. from 40 pcs. 2.40 ea.</p>	<p>The self-adhesive magnetic frames in A5 format can be used on smooth, non-magnetic surfaces. Use them to quickly put up and change notices as needed.</p>
<p><b>MS-100500MWB</b> Whiteboard sheet magnetic magnetic backside 1 x 5 m roll not a magnetic base for magnets Weight: 8 kg</p>	<p>Price in CHF</p> <p>1 pc. 129.70 ea.</p>	<p>With this magnetic whiteboard sheet you can turn an iron surface into a whiteboard in no time. Just cut the sheet to the desired size and attach it to an iron surface.</p>
<p><b>MS-A4</b> Coloured magnetic sheet for labelling and arts &amp; crafts A4 format in different colours Weight: 230 g</p>	<p>Price in CHF</p> <p>1 pc. 3.35 ea. from 3 pcs. 2.90 ea. from 10 pcs. 2.50 ea. from 20 pcs. 2.30 ea. from 40 pcs. 2.15 ea.</p>	<p>For labelling, arts &amp; crafts, marking - the only limit is your imagination. The A4 magnetic sheets are available in 13 different colours. The sheet is 1 mm thick and you can cut it and write on it.</p>
<p><b>MS-A4-STIC</b> Self-adhesive magnetic sheet to cut &amp; glue A4 format grey-black Weight: 230 g</p>	<p>Price in CHF</p> <p>1 pc. 3.45 ea. from 3 pcs. 3.00 ea. from 10 pcs. 2.55 ea. from 20 pcs. 2.35 ea. from 40 pcs. 2.20 ea.</p>	<p>The A4 magnetic sheet with self-adhesive side can be cut to the desired size and lends itself to hanging up larger objects that require an increased adhesive force.</p>
<p><b>NMS-A4-STIC</b> Self-adhesive magnetic sheet neodymium with extra-strong adhesive force to cut &amp; glue A4 format, grey-black Weight: 470 g</p>	<p>Price in CHF</p> <p>1 pc. 69.50 ea. from 3 pcs. 63.15 ea. from 10 pcs. 57.45 ea. from 20 pcs. 54.70 ea. from 40 pcs. 52.25 ea.</p>	<p>Self-adhesive magnetic sheet made of neodymium with an adhesive force of 450 g/cm<sup>2</sup></p>
<p><b>MIP-A4-01</b> Magnetic paper glossy perfect for photo magnets printable on inkjet printers set of 10 A4 sheets Weight: 500 g/set</p>	<p>Price in CHF</p> <p>1 set 11.95/set</p>	<p>With this magnetic paper (glossy) you can turn your photos into individual fridge magnets in no time. Print photo on this paper, cut it to the desired size, attach it to a metal surface - done!</p>



<p><b>MIP-A4-02</b> Magnetic paper matt perfect for photo magnets printable on inkjet printers set of 10 A4 sheets Weight: 420 g/set</p>	<p>Price in CHF 1 set 11.95/set</p>	<p>With this magnetic paper (matt) you can turn your photos into individual fridge magnets in no time. Print photo on this paper, cut it to the desired size, attach it to a metal surface - done!</p>
<p><b>QMS-A4</b> Magnetic frame A4 magnetic pouch to display information for whiteboards, cupboards, etc. in different colours Weight: 100 g</p>	<p>Price in CHF 1 pc. 3.65 ea. from 3 pcs. 3.15 ea. from 10 pcs. 2.75 ea. from 20 pcs. 2.55 ea. from 40 pcs. 2.35 ea.</p>	<p>With the magnetic frames you can display and protect work schedules, statistics or notes in A4 format on whiteboards or other ferromagnetic surfaces.</p>
<p><b>QMS-A5</b> Magnetic frame A5 magnetic pouch to display information for whiteboards, cupboards, etc. in different colours Weight: 69 g</p>	<p>Price in CHF 1 pc. 3.45 ea. from 3 pcs. 3.00 ea. from 10 pcs. 2.60 ea. from 20 pcs. 2.40 ea. from 40 pcs. 2.25 ea.</p>	<p>With the magnetic frames you can display and protect work schedules, statistics or notes in A5 format on whiteboards or other ferromagnetic surfaces.</p>

## Self-adhesive magnetic squares and circles for a wide range of applications

<p><b>LIV-170</b> Magnetic squares self-adhesive 10 x 10 mm square-shaped 160 pieces per sheet Weight: 60 g</p>	<p>Price in CHF 1 pc. 3.10 ea. from 3 pcs. 2.60 ea. from 10 pcs. 2.15 ea. from 20 pcs. 1.95 ea. from 40 pcs. 1.75 ea.</p>	<p>You can use these self-adhesive magnetic squares to attach photos, cards, drawings, etc. to iron surfaces. If you order one piece, you will receive one sheet with 160 magnetic squares sized 10 x 10 mm.</p>
<p><b>LIV-168</b> Magnetic squares self-adhesive 20 x 20 mm square-shaped 40 pieces per sheet Weight: 60 g</p>	<p>Price in CHF 1 pc. 3.25 ea. from 3 pcs. 2.75 ea. from 10 pcs. 2.30 ea. from 20 pcs. 2.05 ea. from 40 pcs. 1.85 ea.</p>	<p>You can use these self-adhesive magnetic squares to attach photos, cards, drawings, etc. to iron surfaces. If you order one piece, you will receive one sheet with 40 magnetic squares sized 20 x 20 mm.</p>
<p><b>LIV-169</b> Magnetic squares self-adhesive 30 x 30 mm square-shaped 20 pieces per sheet Weight: 70 g</p>	<p>Price in CHF 1 pc. 3.15 ea. from 3 pcs. 2.65 ea. from 10 pcs. 2.20 ea. from 20 pcs. 1.95 ea. from 40 pcs. 1.75 ea.</p>	<p>You can use these self-adhesive magnetic squares to attach photos, cards, drawings, etc. to iron surfaces. If you order one piece, you will receive one sheet with 20 magnetic squares sized 30 x 30 mm.</p>
<p><b>LIV-171</b> Magnetic circles self-adhesive Ø 10 mm round 60 pieces per sheet Weight: 60 g</p>	<p>Price in CHF 1 pc. 3.10 ea. from 3 pcs. 2.60 ea. from 10 pcs. 2.15 ea. from 20 pcs. 1.95 ea. from 40 pcs. 1.75 ea.</p>	<p>Use these round self-adhesive magnetic circles to attach photos, cards, drawings, etc. to iron surfaces. If you order one piece, you will receive one sheet containing 60 magnetic dots with a diameter of 10 mm.</p>
<p><b>LIV-172</b> Magnetic circles self-adhesive Ø 20 mm round 24 pieces per sheet Weight: 60 g</p>	<p>Price in CHF 1 pc. 3.10 ea. from 3 pcs. 2.60 ea. from 10 pcs. 2.15 ea. from 20 pcs. 1.95 ea. from 40 pcs. 1.75 ea.</p>	<p>Use these round self-adhesive magnetic circles to attach photos, cards, drawings, etc. to iron surfaces. If you order one piece, you will receive one sheet containing 24 magnetic dots with a diameter of 20 mm.</p>

## Magnetic labels / magnetic signs for flexible labelling of shelves and closets

You can use magnetic c-profiles to label iron cupboards, storage shelves, drawers, etc. in a professional and flexible way. These practical magnetic labels will be delivered with a blank paper insert and a protective PVC foil.

<p><b>MIP-A4-03</b> Magnetic labels printable A4 sheets with perforated labels printable on inkjet printers for labelling metal shelves, whiteboards, etc. Weight: 470 g</p>	<p>Price in CHF 1 pc. 39.95 ea.</p>	<p>Printable magnetic labels by Avery. The labels can be printed on inkjet printers and are easily separated afterwards, thanks to the perforation.</p>
<p><b>CP-40100</b> Magnetic labels 100 x 40 mm magnetic C-profiles printable on inkjet and laser printers for labelling metal shelves Weight: 21 g</p>	<p>Price in CHF 10 pcs. 0.56 ea. from 40 pcs. 0.46 ea. from 80 pcs. 0.42 ea. from 160 pcs. 0.38 ea.</p>	<p>With these 100 x 40 mm magnetic labels you can label iron cupboards, shelves, drawers, etc. in a clean and flexible way.</p>
<p><b>CP-3080</b> Magnetic labels 80 x 30 mm magnetic C-profiles printable on inkjet and laser printers for labelling metal shelves Weight: 12 g</p>	<p>Price in CHF 10 pcs. 0.42 ea. from 40 pcs. 0.34 ea. from 80 pcs. 0.31 ea. from 160 pcs. 0.28 ea.</p>	<p>With these 80 x 30 mm magnetic labels you can label iron cupboards, shelves, drawers, etc. in a clean and flexible way.</p>
<p><b>CP-2060</b> Magnetic labels 60 x 20 mm magnetic C-profiles printable on inkjet and laser printers for labelling metal shelves Weight: 6 g</p>	<p>Price in CHF 10 pcs. 0.33 ea. from 40 pcs. 0.27 ea. from 80 pcs. 0.25 ea. from 160 pcs. 0.22 ea.</p>	<p>With these 60 x 20 mm magnetic labels you can label iron cupboards, shelves, drawers, etc. in a clean and flexible way.</p>
<p><b>CP-1040</b> Magnetic labels 40 x 10 mm magnetic C-profiles printable on inkjet and laser printers for labelling metal shelves Weight: 2 g</p>	<p>Price in CHF 10 pcs. 0.25 ea. from 40 pcs. 0.21 ea. from 80 pcs. 0.19 ea. from 160 pcs. 0.17 ea.</p>	<p>With these 40 x 10 mm magnetic labels you can label iron cupboards, shelves, drawers, etc. in a clean and flexible way.</p>
<p><b>BA-015LN</b> Letters &amp; numbers magnetic for labelling metal shelves 2-piece set 120 characters per A4 sheet Weight: 510 g/set</p>	<p>Price in CHF 1 set 13.60/set from 3 sets 11.65/set from 10 sets 9.90/set from 20 sets 9.05/set from 40 sets 8.30/set</p>	<p>Sets with punch-out magnetic letters or numbers (two A4 sheets each). The black characters on white background work well on whiteboards, magnetic boards or for labeling metal shelves.</p>
<p><b>BA-022</b> Days of the week magnets for organisation and planning 2-piece set 56 magnets per A5 sheet Weight: 240 g/set</p>	<p>Price in CHF 1 set 4.40/set from 3 sets 3.85/set from 10 sets 3.35/set from 20 sets 3.10/set from 40 sets 2.85/set</p>	<p>One set includes two A5 sheets, each containing 56 days of the week magnets. Each sheet has 28 magnets with the days written out and 28 with abbreviated days. Perfect for planning boards.</p>
<p><b>BA-023</b> Month magnets for organisation and planning 2-piece set 60 magnets per A5 sheet Weight: 240 g/set</p>	<p>Price in CHF 1 set 4.70/set from 3 sets 4.15/set from 10 sets 3.60/set from 20 sets 3.35/set from 40 sets 3.15/set</p>	<p>One set includes two A5 sheets with 60 month magnets each. Each sheet has 30 magnets with the months written out and 30 with abbreviated months. Perfect for planning boards.</p>

**CP-INLAY**

Label replacement paper  
blank insert for magnetic  
labels  
10 sheets per package  
Weight: 75 g/set

Price in CHF

	1 set	7.25/set
from	3 sets	6.30/set
from	10 sets	5.45/set
from	20 sets	4.95/set
from	40 sets	4.75/set

These perforated A4 sheets contain inserts that fit exactly into our magnetic label holders. The sheets can be used in standard printers.

## Office magnets and noticeboard magnets: strong hold on whiteboard and magnetic

These strong neodymium office magnets are perfectly suitable for whiteboards, magnetic walls and school blackboards. They are multiple times stronger than standard ferrite office magnets.

On magnetic glass boards, however, only certain types of office magnets can be used, depending on the thickness of the glass.

<p><b>M-102</b> Magnet with handle small, holds approx. 5 kg strong ferrite magnet in a steel pot with black knob handle Ø 38 mm Weight: 43 g strength: approx. 5 kg</p>	<p>Price in CHF 1 pc. 6.50 ea.</p>	<p>Strong, sturdy magnet with handle and 5 kg adhesive force for versatile hanging of clothing, bags or signs, e.g. in the workshop or office.</p>
<p><b>M-103</b> Magnet with handle medium, holds approx. 9 kg strong ferrite magnet in a steel pot with black knob handle Ø 51 mm Weight: 83 g strength: approx. 9 kg</p>	<p>Price in CHF 1 pc. 8.20 ea.</p>	<p>Strong, sturdy magnet with handle and 9 kg adhesive force for versatile hanging of clothing, bags or signs, e.g. in the workshop or office.</p>
<p><b>M-104</b> Magnet with handle large, holds approx. 12 kg strong ferrite magnet in a steel pot with black knob handle Ø 67 mm Weight: 200 g strength: approx. 12 kg</p>	<p>Price in CHF 1 pc. 9.95 ea.</p>	<p>Strong, sturdy magnet with handle and 12 kg adhesive force for versatile hanging of clothing, bags or signs, e.g. in the workshop or office.</p>
<p><b>M-95</b> Disc magnets with silicone coating, holds approx. 800 g board magnets neodymium, adhere on both sides set of 10, Ø 18 mm assorted colours Weight: 76 g/set strength: approx. 800 g</p>	<p>Price in CHF 1 set 23.70/set</p>	<p>10 in a set, colour-assorted (2 each in blue, yellow, grey, green, orange). Good grip, coated with silicone.</p>
<p><b>M-98</b> Sphere magnets with silicone coating, holds approx. 600 g board magnets neodymium set of 4 Ø 12 mm, blue Weight: 45 g/set strength: approx. 600 g</p>	<p>Price in CHF 1 set 11.25/set</p>	<p>These blue sphere magnets are coated with silicone, making them especially easy to grip. They are great for use on whiteboards, magnetic boards and glass memo boards.</p>
<p><b>M-OF-S08</b> Knob magnets with metal casing, holds approx. 1.5 kg office magnets neodymium with grooved handle Weight: 6 g strength: approx. 1.5 kg</p>	<p>Price in CHF 10 pcs. 1.95 ea.</p>	<p>Neodymium knob magnets with metal casing. The grooves on the grip ensure that you can easily remove these magnets from ferromagnetic surfaces.</p>
<p><b>M-OF-W08</b> Office magnets with metal casing, holds approx. 1.5 kg neodymium magnets edge length 8 mm Weight: 4 g strength: approx. 1.5 kg</p>	<p>Price in CHF 10 pcs. 1.85 ea.</p>	<p>This nickel-coated metal casing contains a small but strong neodymium magnet.</p>
<p><b>M-PC</b> Board magnets cylindrical, holds approx. 3.9 kg neodymium magnets with plastic cap Ø 14 mm in different colours Weight: 7.7 g strength: approx. 3.9 kg</p>	<p>Price in CHF 5 pcs. 1.99 ea. from 15 pcs. 1.79 ea. from 40 pcs. 1.64 ea. from 80 pcs. 1.54 ea.</p>	<p>Ideal for magnetic glass boards, whiteboards, magnetic boards, or walls painted with magnetic paint - strong even on smooth surfaces.</p>

<p><b>M-OF-RD30</b> Board magnets made of ferrite set of 10 office magnets Ø 30 mm in different colours Weight: 14 g/set</p>	<p>Price in CHF 1 set 4.95/set</p>	<p>Classical ferrite board magnet that can be easily grasped thanks to its plastic cap. Available in different colours.</p>
<p><b>M-OF-P17</b> Knob magnets with eyelet, holds approx. 3 kg strong office magnets neodymium plasticised in different colours Weight: 7 g strength: approx. 3 kg</p>	<p>Price in CHF 10 pcs. 1.25 ea.</p>	<p>This plastic-covered magnet is very handy thanks to its broad knob.</p>
<p><b>M-PIN</b> Magnetic pins 'Player', holds approx. 1.6 kg bulletin board magnets in the shape of a pawn in a game, Ø 12.5 mm set of 10 in different colours Weight: 28 g/set strength: approx. 1.6 kg</p>	<p>Price in CHF 1 set 11.85/set from 3 sets 10.25/set from 10 sets 8.80/set from 30 sets 8.05/set</p>	<p>Very strong magnetic pin with practical knob. Holds ten A4 sheets of paper with no problem. In various colours. Set of 10 pins.</p>
<p><b>M-81</b> Flag magnets board magnets neodymium, for presenting and organising assorted set of 6 Weight: 8.5 g/set</p>	<p>Price in CHF 1 set 9.95/set</p>	<p>Flag magnets that can also be used on pin boards thanks to the removable flag needle.</p>
<p><b>BX-RD20</b> Office magnets 'Boston Xtra Mini' round, holds approx. 1.5 kg noticeboard magnets neodymium Ø 20 mm, set of 10 in different colours Weight: 49 g/set strength: approx. 1.5 kg</p>	<p>Price in CHF 1 set 9.65/set from 3 sets 8.45/set from 10 sets 7.40/set from 20 sets 6.85/set from 40 sets 6.40/set</p>	<p>A small, discreet plastic magnet, which - despite its small size - is stronger than many large magnets.</p>
<p><b>M-OF-BRD25</b> Board magnets round, holds approx. 1.5 kg neodymium magnets with plastic cap adhesive on both sides, Ø 25 mm in different colours Weight: 12 g strength: approx. 1.5 kg</p>	<p>Price in CHF 5 pcs. 1.55 ea.</p>	<p>The transparent neodymium board magnets are especially suitable for glass memo boards. They also look good on whiteboards and magnetic boards. They can be attached on either side!</p>
<p><b>BX-RD30</b> Office magnets 'Boston Xtra' round, holds approx. 1.5 kg noticeboard magnets neodymium Ø 32.6 mm, set of 5 in different colours Weight: 54 g/set strength: approx. 1.5 kg</p>	<p>Price in CHF 1 set 7.50/set from 3 sets 6.50/set from 10 sets 5.65/set from 20 sets 5.20/set from 40 sets 4.85/set</p>	<p>An office magnet that is strong and pretty! The whiteboard magnet Boston Xtra round contains a super magnet and is therefore two to three times as strong as a standard ferrite office magnet.</p>
<p><b>BX-RD30-BULK</b> Office magnets 'Boston Xtra' round 25 pieces, holds approx. 1.5 kg noticeboard magnets neodymium Ø 32.6 mm, set of 25 in different colours Weight: 160 g/set strength: approx. 1.5 kg</p>	<p>Price in CHF 1 set 29.80/set from 3 sets 26.20/set from 10 sets 23.05/set</p>	<p>BX-RD30 in a box of 25.</p>
<p><b>BX-TR30</b> Office magnets 'Boston Xtra' triangular, holds approx. 1.5 kg noticeboard magnets neodymium set of 5 in different colours Weight: 54 g/set strength: approx. 1.5 kg</p>	<p>Price in CHF 1 set 7.50/set from 3 sets 6.50/set from 10 sets 5.65/set from 20 sets 5.20/set from 40 sets 4.85/set</p>	<p>An office magnet that is strong and pretty! The whiteboard magnet Boston Xtra triangular contains a super magnet and is therefore two to three times as strong as a standard ferrite office magnet.</p>

<p><b>BX-TR30-BULK</b> Office magnets 'Boston Xtra' triangular 25 pieces, holds approx. 1.5 kg noticeboard magnets neodymium set of 25 in different colours Weight: 160 g/set strength: approx. 1.5 kg</p>	<p>Price in CHF</p> <table> <tr><td>1 set</td><td>29.80/set</td></tr> <tr><td>from 3 sets</td><td>26.20/set</td></tr> <tr><td>from 10 sets</td><td>23.05/set</td></tr> </table>	1 set	29.80/set	from 3 sets	26.20/set	from 10 sets	23.05/set	<p>BX-TR30 in a box of 25.</p>				
1 set	29.80/set											
from 3 sets	26.20/set											
from 10 sets	23.05/set											
<p><b>BX-SQ30</b> Office magnets 'Boston Xtra' square, holds approx. 1.5 kg noticeboard magnets neodymium set of 5 in different colours Weight: 54 g/set strength: approx. 1.5 kg</p>	<p>Price in CHF</p> <table> <tr><td>1 set</td><td>7.50/set</td></tr> <tr><td>from 3 sets</td><td>6.50/set</td></tr> <tr><td>from 10 sets</td><td>5.65/set</td></tr> <tr><td>from 20 sets</td><td>5.20/set</td></tr> <tr><td>from 40 sets</td><td>4.85/set</td></tr> </table>	1 set	7.50/set	from 3 sets	6.50/set	from 10 sets	5.65/set	from 20 sets	5.20/set	from 40 sets	4.85/set	<p>An office magnet that is strong and pretty! The whiteboard magnet Boston Xtra square contains a super magnet and is therefore two to three times as strong as a standard ferrite office magnet.</p>
1 set	7.50/set											
from 3 sets	6.50/set											
from 10 sets	5.65/set											
from 20 sets	5.20/set											
from 40 sets	4.85/set											
<p><b>BX-SQ30-BULK</b> Office magnets 'Boston Xtra' square 25 pieces, holds approx. 1.5 kg noticeboard magnets neodymium set of 25 in different colours Weight: 170 g/set strength: approx. 1.5 kg</p>	<p>Price in CHF</p> <table> <tr><td>1 set</td><td>29.80/set</td></tr> <tr><td>from 3 sets</td><td>26.20/set</td></tr> <tr><td>from 10 sets</td><td>23.05/set</td></tr> </table>	1 set	29.80/set	from 3 sets	26.20/set	from 10 sets	23.05/set	<p>BX-SQ30 in a box of 25.</p>				
1 set	29.80/set											
from 3 sets	26.20/set											
from 10 sets	23.05/set											
<p><b>PBM-12</b> Office magnets 'Steel 12', holds approx. 1.5 kg neodymium magnets in steel pot Ø 12 mm Weight: 5 g strength: approx. 1.5 kg</p>	<p>Price in CHF</p> <table> <tr><td>5 pcs.</td><td>1.28 ea.</td></tr> <tr><td>from 15 pcs.</td><td>1.12 ea.</td></tr> <tr><td>from 40 pcs.</td><td>1.01 ea.</td></tr> <tr><td>from 80 pcs.</td><td>0.93 ea.</td></tr> </table>	5 pcs.	1.28 ea.	from 15 pcs.	1.12 ea.	from 40 pcs.	1.01 ea.	from 80 pcs.	0.93 ea.	<p>The smallest of the steel office magnets. A fine piece at a low cost.</p>		
5 pcs.	1.28 ea.											
from 15 pcs.	1.12 ea.											
from 40 pcs.	1.01 ea.											
from 80 pcs.	0.93 ea.											
<p><b>PBM-22</b> Office magnets 'Steel 22', holds approx. 4 kg neodymium magnets in steel pot Ø 22 mm Weight: 20 g strength: approx. 4 kg</p>	<p>Price in CHF</p> <table> <tr><td>1 pc.</td><td>2.25 ea.</td></tr> <tr><td>from 3 pcs.</td><td>1.95 ea.</td></tr> <tr><td>from 10 pcs.</td><td>1.70 ea.</td></tr> <tr><td>from 20 pcs.</td><td>1.60 ea.</td></tr> <tr><td>from 40 pcs.</td><td>1.45 ea.</td></tr> </table>	1 pc.	2.25 ea.	from 3 pcs.	1.95 ea.	from 10 pcs.	1.70 ea.	from 20 pcs.	1.60 ea.	from 40 pcs.	1.45 ea.	<p>Exceptionally strong and beautiful steel office magnet. The surface is nickel-plated and brushed.</p>
1 pc.	2.25 ea.											
from 3 pcs.	1.95 ea.											
from 10 pcs.	1.70 ea.											
from 20 pcs.	1.60 ea.											
from 40 pcs.	1.45 ea.											
<p><b>PBM-25</b> Office magnets 'Steel 25', holds approx. 8 kg neodymium magnets in steel pot Ø 25 mm Weight: 27 g strength: approx. 8 kg</p>	<p>Price in CHF</p> <table> <tr><td>1 pc.</td><td>2.55 ea.</td></tr> <tr><td>from 3 pcs.</td><td>2.20 ea.</td></tr> <tr><td>from 10 pcs.</td><td>1.90 ea.</td></tr> <tr><td>from 20 pcs.</td><td>1.80 ea.</td></tr> <tr><td>from 40 pcs.</td><td>1.65 ea.</td></tr> </table>	1 pc.	2.55 ea.	from 3 pcs.	2.20 ea.	from 10 pcs.	1.90 ea.	from 20 pcs.	1.80 ea.	from 40 pcs.	1.65 ea.	<p>The bigger and older brother of the Steel 22. With its adhesive force of 8 kg, it is certainly not easily removed from a piece of metal.</p>
1 pc.	2.55 ea.											
from 3 pcs.	2.20 ea.											
from 10 pcs.	1.90 ea.											
from 20 pcs.	1.80 ea.											
from 40 pcs.	1.65 ea.											
<p><b>PBM-30</b> Office magnets 'Steel 30', holds approx. 12 kg neodymium magnets in steel pot Ø 30 mm Weight: 40 g strength: approx. 12 kg</p>	<p>Price in CHF</p> <table> <tr><td>1 pc.</td><td>3.50 ea.</td></tr> <tr><td>from 3 pcs.</td><td>3.05 ea.</td></tr> <tr><td>from 10 pcs.</td><td>2.65 ea.</td></tr> <tr><td>from 20 pcs.</td><td>2.50 ea.</td></tr> <tr><td>from 40 pcs.</td><td>2.30 ea.</td></tr> </table>	1 pc.	3.50 ea.	from 3 pcs.	3.05 ea.	from 10 pcs.	2.65 ea.	from 20 pcs.	2.50 ea.	from 40 pcs.	2.30 ea.	<p>This XXL edition with over 10 kg adhesive force is ideal for finger strength training. It's also optimal for metal plates and similar.</p>
1 pc.	3.50 ea.											
from 3 pcs.	3.05 ea.											
from 10 pcs.	2.65 ea.											
from 20 pcs.	2.50 ea.											
from 40 pcs.	2.30 ea.											
<p><b>M-100</b> Knob magnets metal 'Hold-it', holds approx. 3.9 kg strong office magnets neodymium set of 4 Weight: 51 g/set strength: approx. 3.9 kg</p>	<p>Price in CHF</p> <table> <tr><td>1 set</td><td>13.90/set</td></tr> </table>	1 set	13.90/set	<p>The metal knob magnets 'Hold it' have a practical groove at one end. Thanks to this shape, they are perfect for hanging keys or towels, for example.</p>								
1 set	13.90/set											
<p><b>M-105</b> Magnetic pins 'Mini Max' rainbow-coloured, holds approx. 3.9 kg strong office magnets neodymium set of 4 Weight: 45 g/set strength: approx. 3.9 kg</p>	<p>Price in CHF</p> <table> <tr><td>1 set</td><td>12.90/set</td></tr> </table>	1 set	12.90/set	<p>The popular 'Mini Max' office magnets are now also available in rainbow colours. They are easy to grip thanks to the handle, and also have an impressive adhesive force.</p>								
1 set	12.90/set											

<p><b>M-52</b> Magnetic pins 'Mini Max' silver-coloured, holds approx. 3.9 kg strong office magnets neodymium set of 4 Weight: 45 g/set strength: approx. 3.9 kg</p>	<p>Price in CHF 1 set 12.90/set</p>	<p>These silver magnets with a knob have an impressive adhesive force, are easy to grasp and look classy. Perfect for the office or as a practical and pretty gift.</p>
<p><b>M-99</b> Magnetic pins 'Mini-Max' silver-blue, holds approx. 3.9 kg strong office magnets neodymium set of 4 Weight: 45 g/set strength: approx. 3.9 kg</p>	<p>Price in CHF 1 set 12.90/set</p>	<p>The popular Mini-Max office magnets are now available in a crisp silver-blue colour choice. They sit comfortably in your hand, thanks to the knob, and also have an impressive adhesive force.</p>
<p><b>M-51</b> Magnetic pins 'The Boss', holds approx. 7 kg strong office magnets neodymium set of 3 Weight: 140 g/set strength: approx. 7 kg</p>	<p>Price in CHF 1 set 15.90/set</p>	<p>These magnetic pins have an impressive 7 kg adhesive force, are easy to grasp and look very sophisticated. Perfect for the office or as a practical and pretty gift.</p>
<p><b>M-97</b> Magnetic keychain, holds approx. 200 g strong neodymium magnets with keyring set of 3 Weight: 53 g/set strength: approx. 200 g</p>	<p>Price in CHF 1 set 11.90/set</p>	<p>A strong magnet is built into each keychain, so going forward, your keys will stick to almost any metallic surface. Perfect when combined with magnetic boards or magnetic strips.</p>
<p><b>M-20</b> Boss Magnet small, holds approx. 3.9 kg exclusive office magnet neodymium made of aluminium Weight: 10 g strength: approx. 3.9 kg</p>	<p>Price in CHF 1 pc. 6.85 ea. from 3 pcs. 6.20 ea. from 10 pcs. 5.65 ea. from 20 pcs. 5.35 ea. from 40 pcs. 5.10 ea.</p>	<p>The grip is made out of a piece of aluminium and a 12 x 6 mm magnetic disc has been inserted. This exclusive magnet is produced especially for us in a small workshop in Switzerland and is of the finest Swiss quality.</p>
<p><b>M-21</b> Boss magnet large, holds approx. 12 kg exclusive office magnet neodymium made of aluminium Weight: 47 g strength: approx. 12 kg</p>	<p>Price in CHF 1 pc. 12.00 ea. from 3 pcs. 10.95 ea. from 10 pcs. 10.00 ea. from 20 pcs. 9.55 ea. from 40 pcs. 9.15 ea.</p>	<p>The Mercedes Maybach of office magnets! 12 kg adhesive force - enough to affix 50 sheets of A4 paper to the wall!</p>
<p><b>M-DOTS</b> Magnet pins round, holds approx. 2.7 kg noticeboard magnets neodymium Ø 13 mm, set of 10 different colours Weight: 50 g/set strength: approx. 2.7 kg</p>	<p>Price in CHF 1 set 11.75/set</p>	<p>Assorted in ten bright colours, these pin board magnets with embedded neodymium magnet are perfect for office, workshop or home.</p>



## Office accessories: practical helpers for office and desk

Here you can find decorative articles that will pimp your office routine and your desk: Elegant and original paper clip holders, paperweights, pencil holders and letter openers. Some of the articles are not magnetic, which is mentioned in the product description.

<p><b>M-MLY-13</b> Binder clips "mauly" 13 mm metal set of 12 not magnets! Weight: 110 g/set</p>	<p>Price in CHF 1 set 1.65/set</p>	<p>Binder clips made of rust-resistant spring steel, allowing you to clip together 130 sheets of paper weighing 80 g/ m<sup>2</sup>. One set contains 12 clips.</p>
<p><b>M-MLY-19</b> Binder clips "mauly" 19 mm metal set of 12 not magnets! Weight: 180 g/set</p>	<p>Price in CHF 1 set 2.95/set</p>	<p>Large binder clips made of rust-resistant spring steel, allowing you to clip together 190 sheets of paper weighing 80 g/ m<sup>2</sup>. One set contains 12 clips.</p>
<p><b>M-85</b> Letter clamp 95 mm made of metal, black set of 2 not magnets! Weight: 80 g/set</p>	<p>Price in CHF 1 set 10.65/set</p>	<p>Practical file clamps with many positive features: practically indestructible, powerful, warp resistant, universal use. Ideal for storing, reminding, bundling, pressing or gluing of letters, documents, files, and notes.</p>
<p><b>M-87</b> Letter clamp 50 mm made of metal, silver-coloured set of 10 not magnets! Weight: 80 g/set</p>	<p>Price in CHF 1 set 6.20/set</p>	<p>Practical file clamps with many positive features: Sturdy, strong, universal use. Ideal for storing, reminding, bundling, pressing or gluing letters, documents, files, and notes.</p>
<p><b>M-CLIP</b> Paper clip dispenser magnetic with strong magnet in the centre plastic in different colours Weight: 90 g</p>	<p>Price in CHF 1 pc. 7.10 ea.</p>	<p>This magnetic paper clip dispenser for the office or the desk at home keeps paperclips handy. It is made of shatter-proof plastic and available in nine different colours.</p>
<p><b>BA-013</b> Magnetic clips MAUL self-adhesive set of 10 Weight: 190 g/set</p>	<p>Price in CHF 1 set 23.15/set</p>	<p>Self-adhesive magnetic clips for hanging important information, such as drawings. Just insert material into the clips. They snap shut automatically, so even large maps can be hung by just one person.</p>
<p><b>M-57</b> Paper clips colourful 100 pieces per package Weight: 48 g/set</p>	<p>Price in CHF 1 set 1.70/set from 3 sets 1.55/set from 10 sets 1.40/set</p>	<p>Pretty plastic-covered paper clips. Perfect accessories to our magnetic paper clip holders.</p>

## Fridge magnets - attractive colourful & decorative magnets

Here you can find attractive colourful magnets for decoration or gifts in all imaginable shapes and materials. Most of them are perfectly suitable to use on a refrigerator or photo rope.

<b>LIV-140</b> Trauffer wooden animals magnetic handmade fridge magnets 4 different animals available Weight: 14 g	Price in CHF 1 pc. 11.60 ea.	We embedded a small but strong super magnet in the back of each wooden animal, turning these Trauffer animals into practical and decorative refrigerator magnets.
<b>LIV-141</b> Trauffer wooden cows magnetic handmade fridge magnets 2 different cows available Weight: 14 g	Price in CHF 1 pc. 9.80 ea.	The cows made by traditional Swiss brand Trauffer now have superpowers! We embedded a small but strong super magnet in the back of each wooden cow.
<b>LIV-151</b> Fridge magnets 'Brass' sphere-shaped set of 4, gold-coloured Weight: 52 g/set	Price in CHF 1 set 8.95/set	Thanks to their golden colour, the sphere-shaped decorative "Brass" magnets provide a stylish focal point and modern touch.
<b>SALE-128</b> Squirrel magnets squirrel-shaped fridge magnets set of 5 Weight: 67 g/set	Price in CHF 1 set 4.95/set	This happy group of squirrels is looking forward to serving on refrigerators and magnetic boards. They will make sure that your notes and photos stay in their assigned spot.
<b>LIV-117</b> Smiley magnet 'Girl' plasticised, yellow Weight: 9 g	Price in CHF 1 pc. 1.00 ea.	Cute smiley magnet that spreads good mood in every room.
<b>LIV-118</b> Glass magnets rescue vehicles handmade fridge magnets set of 3 Weight: 18 g/set	Price in CHF 1 set 10.00/set	Pretty glass magnets with rescue vehicles. Handmade in Switzerland.
<b>LIV-119</b> Glass magnets lucky charm handmade fridge magnets set of 3 Weight: 18 g/set	Price in CHF 1 set 10.00/set	Pretty glass magnets with lucky charms. Handmade in Switzerland.
<b>LIV-120</b> Glass magnets legendary animals handmade fridge magnets set of 3 Weight: 18 g/set	Price in CHF 1 set 10.00/set	Decorative glass magnets with hand-painted iconic animals - each of them one-of-a-kind

<p><b>LIV-128</b> Glass magnets shore animals handmade fridge magnets set of 3 Weight: 18 g/set</p>	<p>Price in CHF 1 set 10.00/set</p>	<p>Decorative glass magnets with hand-painted shore animal designs - each piece is one-of-a-kind.</p>
<p><b>LIV-129</b> Glass magnets Halloween handmade fridge magnets set of 3 Weight: 18 g/set</p>	<p>Price in CHF 1 set 10.00/set</p>	<p>Decorative glass magnets with hand-painted Halloween designs - each piece is one-of-a-kind.</p>
<p><b>LIV-121</b> Glass magnets cats handmade fridge magnets set of 3 Weight: 18 g/set</p>	<p>Price in CHF 1 set 10.00/set</p>	<p>Decorative glass magnets with hand-painted cat motifs - each piece is one-of-a-kind.</p>
<p><b>LIV-123</b> MagNICI magnetic plush toys with sewn-in magnet in each paw Weight: 22 g</p>	<p>Price in CHF 1 pc. 9.90 ea.</p>	<p>Who doesn't like the legendary NICI plush toys? We have some running around in our supermagnete assortment - naturally with magnetic feet!</p>
<p><b>LIV-124</b> Smiley magnet 'Boy' plasticised, yellow Weight: 9 g</p>	<p>Price in CHF 1 pc. 1.00 ea.</p>	<p>Cheerful smiley magnet that spreads good mood in every room.</p>
<p><b>LIV-110</b> Fridge magnets 'Crazy Brain', holds approx. 1.8 kg in the shape of a brain assorted set of 12 Weight: 60 g/set strength: approx. 1.8 kg</p>	<p>Price in CHF 1 set 12.00/set</p>	<p>Plastic brains with press-fitted strong neodymium magnet in assorted set of 12.</p>
<p><b>LIV-111</b> Building block magnets 'Classic' with press-fitted magnets assorted set of 14 Weight: 27 g/set</p>	<p>Price in CHF 1 set 11.00/set</p>	<p>Coloured bricks in seven bright colours with pressed-in neodymium magnets.</p>
<p><b>LIV-116</b> Building block magnets 'Candy' with press-fitted magnets assorted set of 12 Weight: 24 g/set</p>	<p>Price in CHF 1 set 9.95/set</p>	<p>Colourful blocks in six bright colours with strong neodymium magnets on the backside.</p>
<p><b>SALE-106</b> Dog magnets made of plastic, velvety set of 5 Weight: 30 g/set</p>	<p>Price in CHF 1 set 4.95/set</p>	<p>Original dog magnets in pastel colours that highlight everything on a magnetic board.</p>

<p><b>SALE-107</b> Teddy magnets made of plastic, velvety set of 4 Weight: 30 g/set</p>	<p>Price in CHF 1 set 4.95/set</p>	<p>Original bear magnets in bright colours that are the highlights on any magnetic board.</p>
<p><b>LIV-95</b> Magnetic plush toys with sewn-in magnets in each front paw Weight: 20 g</p>	<p>Price in CHF 1 pc. 9.90 ea.</p>	<p>Thanks to the strong magnets inside, the friendly fluffy animals adhere to fridge or magnetic board. You can select from 10 different animal species.</p>
<p><b>LIV-44</b> Mini magnets 'Steely', holds approx. 800 g office magnets neodymium, 6 x 3 mm set of 10 in different colours Weight: 24 g/set strength: approx. 800 g</p>	<p>Price in CHF 1 set 9.90/set</p>	<p>Sometimes less is more: Hence, our tiny Steely magnets hold up pictures and documents in a very stylish and discreet fashion. The trendy colours bring pizzazz to your magnetic board, but don't detract from the displayed items.</p>
<p><b>LIV-51</b> Duckies magnets, holds approx. 450 g duck-shaped fridge magnets set of 6 Weight: 50 g/set strength: approx. 450 g</p>	<p>Price in CHF 1 set 9.90/set</p>	<p>In order to have fun with these very colourful mini rubber duckies, you don't even have to draw a bath. These cute deco magnets shaped as ducks are made for setting colourful accents on your magnetic board.</p>
<p><b>LIV-114</b> Piggy magnets pink pig-shaped fridge magnets 3x front side, 3x back side set of 6 Weight: 68 g/set</p>	<p>Price in CHF 1 set 9.90/set</p>	<p>Happy pigs that don't just bring good luck, but also hold notes and postcards on magnetic boards or the fridge.</p>
<p><b>LIV-52</b> Sheep magnets, holds approx. 550 g fridge magnets shaped as sheep set of 6 Weight: 73 g/set strength: approx. 550 g</p>	<p>Price in CHF 1 set 9.90/set</p>	<p>Shepard wanted! This flock of sheep is looking for someone to take care of them. Who could resist these trusting eyes?</p>
<p><b>LIV-90</b> Decorative magnet 'Red Heart', holds approx. 1.5 kg acrylic red heart with zircon incl. organza fabric pouch Weight: 8 g strength: approx. 1.5 kg</p>	<p>Price in CHF 1 pc. 5.49 ea.</p>	<p>Not just for Valentines Day! A red acrylic heart with a little sparkling zircon on the top right. On the backside there is a strong neodymium magnet 12 x 2 mm embedded to hold all those love notes. Each heart is packaged in a silver fabric bag and makes for a great gift.</p>
<p><b>LIV-80</b> Decorative magnets 'Sweetheart', holds approx. 500 g heart-shaped set of 6 Weight: 46 g/set strength: approx. 500 g</p>	<p>Price in CHF 1 set 9.90/set</p>	<p>Cute heart-shaped metal magnets.</p>
<p><b>LIV-66</b> Penguin magnets, holds approx. 500 g penguin-shaped fridge magnets set of 6 Weight: 68 g/set strength: approx. 500 g</p>	<p>Price in CHF 1 set 9.90/set</p>	<p>These penguin magnets will put the limelight on your notes and postcards on the fridge.</p>

<b>LIV-115</b> Unicorn magnets unicorn-shaped fridge magnets white-pink set of 5 Weight: 67 g/set	Price in CHF 1 set 9.90/set	Awesome fridge magnets with strong neodymium magnets that spread - in typical unicorn manner - endless joy, ease, freedom and love.
<b>LIV-130</b> Flamingo magnets flamingo-shaped fridge magnets set of 5 Weight: 64 g/set	Price in CHF 1 set 9.90/set	You love flamingos or everything in pink? We have the right magnets for you. We have the trendy water birds as magnets.
<b>LIV-131</b> Cactus magnets cactus-shaped fridge magnets set of 5 Weight: 66 g/set	Price in CHF 1 set 9.90/set	These cactus magnets are an original way to bring the trendy plants into your home. The best about the magnets: They are fun for plant lovers and people without a green thumb as well.
<b>LIV-132</b> Piggy magnets gold-coloured pig-shaped fridge magnets set of 5 Weight: 42 g/set	Price in CHF 1 set 9.90/set	These gold-coloured piggy magnets are fabulous on all ferromagnetic surfaces and hold notes and cards in place.
<b>LIV-134</b> Llama magnets llama-shaped fridge magnets set of 5 Weight: 48 g/set	Price in CHF 1 set 9.90/set	These cute lama magnets with their colourful little saddles will make you smile and beautify every fridge door.
<b>LIV-135</b> Hedgehog magnets hedgehog-shaped fridge magnets set of 6 Weight: 68 g/set	Price in CHF 1 set 9.90/set	Little magnetic hedgehog family in a set of 6. They like to hang out around notes and postcards.
<b>LIV-138</b> Black cat magnets cat-shaped fridge magnets set of 5 Weight: 41 g/set	Price in CHF 1 set 9.90/set	The playful black cats are looking for a new home. They are low-maintenance, don't shed, and watch over your notes and pictures.
<b>LIV-139</b> Glass magnets Kittens decorative magnets with cat designs set of 4 Weight: 120 g/set	Price in CHF 1 set 9.90/set	The baby cats magnets in black-white melt any cat lover's heart. You can't resist these tiny fluffy paws and the cute little ears.
<b>LIV-142</b> Panda magnets panda-shaped fridge magnets set of 5 Weight: 63 g/set	Price in CHF 1 set 9.90/set	The magnetic pandas love to nestle on metallic surfaces and keep watch over photos, notes and postcards. These adorable bears come in a set of 5.

<p><b>LIV-143</b> Fridge magnets 'Donkey' donkey-shaped set of 5 Weight: 65 g/set</p>	<p>Price in CHF 1 set 9.90/set</p>	<p>These adorable grey magnetic donkeys are made of synthetic resin and are anything but stubborn. They enjoy helping you keep your notes and photos on the refrigerator or on magnetic strips.</p>
<p><b>LIV-145</b> Fridge magnets 'Chicken' chicken-shaped set of 6 Weight: 59 g/set</p>	<p>Price in CHF 1 set 9.90/set</p>	<p>Aren't mama hen and her 5 chicks adorable? These feathered friends love to roost on metallic surfaces and keep watch over your postcards, photos and notes.</p>
<p><b>LIV-146</b> Decorative magnets 'Jewel' jewel-shaped set of 5 Weight: 64 g/set</p>	<p>Price in CHF 1 set 9.90/set</p>	<p>Quantity per set: 5 pieces Sticks to whiteboard: 4 A4 sheets Colour: Transparent Diameter: 19 mm Height: 18 mm</p>
<p><b>LIV-163</b> Ghost magnets ghost-shaped fridge magnets set of 5 Weight: 66 g/set</p>	<p>Price in CHF 1 set 9.90/set</p>	<p>These cute ghost magnets hold your shopping lists, photos and notes on your refrigerator without scaring them away.</p>
<p><b>LIV-164</b> Cat magnets sleeping cat-shaped fridge magnets set of 5 Weight: 66 g/set</p>	<p>Price in CHF 1 set 9.90/set</p>	<p>These five adorable cat magnets have found a cosy sleeping spot on your refrigerator where they hold your notes and photos on the ferromagnetic surface.</p>
<p><b>LIV-165</b> Elephant magnets elephant-shaped fridge magnets set of 5 Weight: 66 g/set</p>	<p>Price in CHF 1 set 9.90/set</p>	<p>With their strong neodymium magnet on the back, these adorable decorative magnets in the shape of elephants firmly hold photos and notes on your refrigerator.</p>
<p><b>LIV-152</b> Fridge magnets 'Space' astronaut-shaped white set of 4 Weight: 75 g/set</p>	<p>Price in CHF 1 set 9.90/set</p>	<p>These astronauts are not only drawn by earth's gravity but also magnetically towards metal surfaces.</p>
<p><b>LIV-153</b> Fridge magnets 'Barry' in the shape of Saint Bernards white-brown set of 5 Weight: 74 g/set</p>	<p>Price in CHF 1 set 9.90/set</p>	<p>The cute Saint Bernards with their characteristic small barrel around the neck will move into their new home as a set of 5.</p>
<p><b>LIV-154</b> Fridge magnets 'Kroko' crocodile-shaped green set of 5 Weight: 69 g/set</p>	<p>Price in CHF 1 set 9.90/set</p>	<p>These little green crocodile magnets will snatch your notes and photos.</p>

<p><b>LIV-155</b> Fridge magnets 'Traffic' car-shaped assorted set of 5 Weight: 77 g/set</p>	<p>Price in CHF 1 set 9.90/set</p>	<p>Let's drive! These colourful resin car magnets with a neodymium magnet underneath are rearing to go.</p>
<p><b>LIV-156</b> Fridge magnet 'Camper' campervan-shaped assorted set of 5 Weight: 84 g/set</p>	<p>Price in CHF 1 set 9.90/set</p>	<p>You can really showcase your photos and holiday memories with these magnets in the shape of small campervans.</p>
<p><b>LIV-174</b> Fridge magnets 'Rocket' rocket-shaped set of 5 Weight: 77 g/set</p>	<p>Price in CHF 1 set 9.90/set</p>	<p>These rockets won't fly away but securely hold your notes at their home base on your refrigerator or magnetic board.</p>
<p><b>LIV-175</b> Fridge magnets 'Octopus' octopus-shaped assorted set of 4 Weight: 75 g/set</p>	<p>Price in CHF 1 set 9.90/set</p>	<p>When you need a hand, these little octopuses will securely hold your notes on the fridge or magnetic board.</p>
<p><b>LIV-127</b> Hippos decorative hippo magnets front and back side magnetic set of 3 Weight: 70 g/set</p>	<p>Price in CHF 1 set 9.90/set</p>	<p>Colourful, friendly hippos that can be used individually to hang up notes and photos on magnetic boards or together as memo holder.</p>
<p><b>LIV-104</b> Frog magnets, holds approx. 500 g frog-shaped fridge magnet set of 5 Weight: 57 g/set strength: approx. 500 g</p>	<p>Price in CHF 1 set 9.90/set</p>	<p>Four friendly frogs and one frog king are looking forward to hopping on your fridge, whiteboard or magnetic board.</p>
<p><b>LIV-63</b> Owl magnets, holds approx. 500 g owl-shaped fridge magnets set of 6 Weight: 57 g/set strength: approx. 500 g</p>	<p>Price in CHF 1 set 9.90/set</p>	<p>These magnetic owls keep an eye on your appointment cards on your fridge or magnetic board. Thanks to the strong magnet on the backside, the owls can hold dup to 7 A4 sheets of paper.</p>
<p><b>LIV-65</b> Cow magnets, holds approx. 500 g cow-shaped fridge magnets set of 6 Weight: 78 g/set strength: approx. 500 g</p>	<p>Price in CHF 1 set 9.90/set</p>	<p>There is no way you can resist the look of these cute cows - two thumbs up!</p>
<p><b>LIV-91</b> Decorative magnet 'Diamond Cat', holds approx. 1.5 kg white cat made of acrylic glass with Swarovski crystals Weight: 15 g strength: approx. 1.5 kg</p>	<p>Price in CHF 1 pc. 24.90 ea. from 3 pcs. 22.90 ea. from 10 pcs. 19.90 ea.</p>	<p>The white kitty sparkles thanks to white and coloured Swarovski crystals. Using the IMPLEXIONS technique, which is unique in the world, precious SWAROVSKI® crystals are embedded seamlessly and without bubbles in high-quality acrylic glass. The cat measures approx. 42 x 47 mm.</p>

<p><b>LIV-92</b> Decorative magnet 'Diamond Dog', holds approx. 1.5 kg black dog made of acrylic glass with Swarovski crystals Weight: 11 g strength: approx. 1.5 kg</p>	<p>Price in CHF 1 pc. 24.90 ea. from 3 pcs. 22.90 ea. from 10 pcs. 19.90 ea.</p>	<p>The little black dog with coloured Swarovski crystals has a strong magnet on the back. Using the IMPLEXIONS technique, which is unique in the world, precious SWAROVSKI® crystals are embedded seamlessly and without bubbles in high-quality acrylic glass. The dog measures approx. 47 x 31 mm.</p>
<p><b>LIV-93</b> Decorative magnet 'Diamond Rabbit', holds approx. 1.5 kg white rabbit made of acrylic glass with Swarovski crystals Weight: 16 g strength: approx. 1.5 kg</p>	<p>Price in CHF 1 pc. 24.90 ea. from 3 pcs. 22.90 ea. from 10 pcs. 19.90 ea.</p>	<p>The white rabbit with the long ears sparkles thanks to white and coloured Swarovski crystals. Using the IMPLEXIONS technique, which is unique in the world, precious SWAROVSKI® crystals are embedded seamlessly and without bubbles in high-quality acrylic glass. The rabbit measures approx. 50 x 27 mm.</p>
<p><b>SALE-089</b> Fridge magnets 'Little rabbit' rabbit-shaped set of 4 Weight: 55 g/set</p>	<p>Price in CHF 1 set 4.95/set</p>	<p>Not just at Easter, but a cute eye-catcher on the fridge all year round.</p>
<p><b>SALE-090</b> Fridge magnets 'Honey' bear-shaped set of 4 Weight: 27 g/set</p>	<p>Price in CHF 1 set 4.95/set</p>	<p>So sweet you would want to bite into them! Unfortunately, the honey bears are not made of sugar, but they last longer.</p>
<p><b>SALE-109</b> Fridge magnets 'Fancy' in the shape of speech bubbles set of 4 Weight: 53 g/set</p>	<p>Price in CHF 1 set 3.90/set</p>	<p>A magnet says more than a thousand words: Especially with these colourful comic speech bubbles.</p>
<p><b>LIV-84</b> Felt magnets 'Teddies', holds approx. 600 g hand-crafted decorative magnets made of felt and glass beads set of 2 Weight: 16 g/set strength: approx. 600 g</p>	<p>Price in CHF 1 set 12.40/set from 3 sets 11.75/set</p>	<p>Magnetic bear set: One brown and one polar bear made of felt with embedded magnet. Hand-made in Switzerland - each piece is a one-of-a-kind!</p>
<p><b>LIV-88</b> Emoticon magnets, holds approx. 650 g fridge magnets square set of 4 Weight: 32 g/set strength: approx. 650 g</p>	<p>Price in CHF 1 set 9.90/set</p>	<p>Funny little square magnets with emoticons. A tiny magnet is attached to the backside of the symbols. The adhesive force is still impressive: A single magnet holds 8 sheets of A4 paper securely on the whiteboard.</p>
<p><b>SALE-092</b> Glass magnets 'Jardin' with garden motifs set of 4 Weight: 100 g/set</p>	<p>Price in CHF 1 set 4.95/set</p>	<p>For all garden enthusiasts we have beautiful vintage magnets in many different green themes.</p>
<p><b>SALE-093</b> Glass magnets 'America' with American motifs set of 4 Weight: 100 g/set</p>	<p>Price in CHF 1 set 4.95/set</p>	<p>Glass magnets with classic American vintage motifs in stylish muted brown and blue shades.</p>



<p><b>SALE-094</b> Glass magnets 'Summer' with summer motifs set of 4 Weight: 100 g/set</p>	<p>Price in CHF 1 set 4.95/set</p>	<p>Finally summer! At least when you have these pretty and happy summer-themed glass magnets on your fridge!</p>
<p><b>SALE-095</b> Glass magnets 'Bouquet' with flower motifs set of 4 Weight: 100 g/set</p>	<p>Price in CHF 1 set 4.95/set</p>	<p>Cute glass magnets with French vintage flower motifs in bright colours.</p>
<p><b>LIV-67</b> Bird magnets, holds approx. 500 g bird-shaped fridge magnets set of 6 Weight: 47 g/set strength: approx. 500 g</p>	<p>Price in CHF 1 set 9.90/set</p>	<p>A little (neon) birdie told me... they like to embellish refrigerator, magnetic board or boring iron surfaces and at the same time hold up to 7 sheets of paper.</p>
<p><b>LIV-64</b> Cat magnets, holds approx. 500 g cat-shaped fridge magnets set of 6 Weight: 68 g/set strength: approx. 500 g</p>	<p>Price in CHF 1 set 9.90/set</p>	<p>Cats always bring luck, no matter if white, black or grey! They are not just cute but also practical and hold your notes and postcards on any metal surface.</p>
<p><b>LIV-81</b> Fridge magnets 'Kitty Cat', holds approx. 500 g cat-shaped set of 6 Weight: 26 g/set strength: approx. 500 g</p>	<p>Price in CHF 1 set 9.90/set</p>	<p>6 cute round cat magnets. The ideal addition to article FL-08 (magnets are identical) - especially when you lost those magnets.</p>
<p><b>LIV-74</b> Fridge magnets vintage bugs antiqued look set of 5 Weight: 190 g/set</p>	<p>Price in CHF 1 set 9.95/set</p>	<p>For bug fans with a knack for bling bling and vintage. These big, shimmering scarabs leave a dazzling impression and definitely stick out!</p>
<p><b>SALE-105</b> Fridge magnets 'Beetle in Glass' antiqued look set of 2 Weight: 62 g/set</p>	<p>Price in CHF 1 set 4.95/set</p>	<p>Beetle magnets made of hand-painted tin in trendy vintage look.</p>
<p><b>LIV-97</b> Concrete magnets, holds approx. 400 g in three different shapes set of 4 Weight: 50 g/set strength: approx. 400 g</p>	<p>Price in CHF 1 set 9.90/set</p>	<p>Decorative magnets made of real concrete will make a great impression in your living or office space.</p>
<p><b>LIV-58</b> Clownfish magnets, holds approx. 550 g fish-shaped fridge magnets set of 6 Weight: 53 g/set strength: approx. 550 g</p>	<p>Price in CHF 1 set 9.90/set</p>	<p>Nemo and his friends are looking for a new home. The little magnetic fish prefer a metal surface to a reef or lagoon.</p>

<p><b>LIV-86</b> Bear magnets, holds approx. 400 g bear-shaped fridge magnets set of 6 Weight: 65 g/set strength: approx. 400 g</p>	<p>Price in CHF 1 set 9.90/set</p>	<p>For all fans of teddybears! Six cute magnetic bears in three different colours watch out for your shopping list on the fridge.</p>
<p><b>LIV-87</b> Gecko magnets, holds approx. 400 g gecko-shaped fridge magnets set of 6 Weight: 66 g/set strength: approx. 400 g</p>	<p>Price in CHF 1 set 9.90/set</p>	<p>Luckily our gecko magnets are not as shy as the real animals and take their note-holding job seriously.</p>
<p><b>LIV-62</b> Piggy magnets multi-coloured, holds approx. 500 g pig-shaped fridge magnets set of 6 Weight: 57 g/set strength: approx. 500 g</p>	<p>Price in CHF 1 set 9.90/set</p>	<p>6 little piggies! These cute magnetic piggies will hopefully bring us luck in our assortment. Thanks to their bright colours they are the eye-catcher on every magnetic board or fridge.</p>
<p><b>LIV-53</b> Ladybird magnets, holds approx. 450 g ladybird-shaped fridge magnets set of 6 Weight: 49 g/set strength: approx. 450 g</p>	<p>Price in CHF 1 set 9.90/set</p>	<p>These cute ladybirds made of resin make for nice little lucky charms and are also very practical as magnets.</p>
<p><b>LIV-57</b> Butterfly magnets, holds approx. 600 g butterfly-shaped fridge magnets set of 4 Weight: 56 g/set strength: approx. 600 g</p>	<p>Price in CHF 1 set 9.90/set</p>	<p>No matter the season, these colourful metal butterflies bring spring fever to your magnetic board.</p>
<p><b>SALE-096</b> Bottle cap magnets fridge magnets set of 4 Weight: 72 g/set</p>	<p>Price in CHF 1 set 4.95/set</p>	<p>Love, spelled out, in modern bottle cap magnets. And of course super-strong thanks to a neodymium magnet on the backside!</p>
<p><b>LIV-56</b> Magnetic words Love words, syllables and punctuation marks 510 pieces available in various languages Weight: 290 g/set</p>	<p>Price in CHF 1 set 19.95/set</p>	<p>A set of magnetic words contains 510 pieces: Words, syllables and punctuation marks. The words printed on magnetic sheet revolve around the topics of love and eroticism.</p>
<p><b>LIV-47</b> Magnetic words words, syllables and punctuation marks 510 pieces available in various languages Weight: 290 g/set</p>	<p>Price in CHF 1 set 19.95/set</p>	<p>A set of magnetic words contains 510 pieces: Words, syllables and punctuation marks. Available in five languages: German, English, French, Dutch and Spanish</p>
<p><b>LIV-45</b> Fridge magnets 'Football magnets', holds approx. 400 g football magnets set of 4 Weight: 48 g/set strength: approx. 400 g</p>	<p>Price in CHF 1 set 12.90/set</p>	<p>This deco magnet in the shape of a football makes the heart of every football fan skip a beat.</p>

<p><b>LIV-43</b> Fridge magnets 'Toadstools', holds approx. 500 g with felt protectors set of 3 Weight: 57 g/set strength: approx. 500 g</p>	<p>Price in CHF 1 set 15.80/set from 3 sets 14.25/set from 10 sets 12.90/set</p>	<p>The carefully crafted super magnets with a toadstool-inspired design help to hold on to important things. And they do it with care: A glued-on felt disc prevents scratches on delicate surfaces.</p>
<p><b>LIV-42</b> Felt magnets 'Adams', holds approx. 600 g hand-crafted decorative magnets made of felt and glass beads set of 3 in different colours Weight: 34 g/set strength: approx. 600 g</p>	<p>Price in CHF 1 set 20.00/set from 3 sets 18.35/set from 10 sets 16.85/set</p>	<p>These amazingly colourful and sensual felt magnets spread vitality all around. Each of those colour bursts has been carefully felted by hand. Even the little glass pearls were sewn on by hand.</p>
<p><b>MANI-01</b> Fridge magnets 'African animals' magnetic mini animals made from old tin cans sale profits go to Children's Aid Madagascar (Kinderhilfe Madagaskar) Weight: 30 g</p>	<p>Price in CHF 1 pc. 13.50 ea.</p>	<p>These magnetic animals are skilfully crafted in Madagascar from old tin cans. All sales proceeds benefit the children's aid organisation zaza malagasy in Madagascar.</p>
<p><b>MCAR-01</b> Fridge magnets 'MadagasCAR' magnetic mini vehicles made of old tin cans sale profits go to Children's Aid Madagascar (Kinderhilfe Madagaskar) Weight: 30 g</p>	<p>Price in CHF 1 pc. 13.50 ea.</p>	<p>These beautiful little cars and planes are manufactured in Madagascar. Handy craftsmen make them with lots of love and creativity out of old tin cans. The entire proceeds from the sale of these little cars and planes go to the Children's Fund in Madagascar.</p>
<p><b>LIV-38</b> Decorative magnet 'Diamond Heart', holds approx. 450 g with heart motif, made of acrylic glass with Swarovski crystals Weight: 13 g strength: approx. 450 g</p>	<p>Price in CHF 1 pc. 25.90 ea. from 3 pcs. 23.85 ea. from 10 pcs. 22.05 ea.</p>	<p>The sparkling diamond heart is not only a head turner, it also holds on to love notes and other memos. Square.</p>
<p><b>LIV-39</b> Decorative magnet 'Lucky Diamond', holds approx. 450 g with four-leaf clover motif, made of acrylic glass with Swarovski crystals Weight: 13 g strength: approx. 450 g</p>	<p>Price in CHF 1 pc. 24.90 ea. from 3 pcs. 22.90 ea. from 10 pcs. 19.90 ea.</p>	<p>The first lucky charm magnet! The sparkling four-leaf clover is not only pretty but also useful and a novel gift idea at that.</p>
<p><b>LIV-40</b> Decorative magnet 'Diamond Star', holds approx. 450 g with star motif, made of acrylic glass with Swarovski crystals Weight: 13 g strength: approx. 450 g</p>	<p>Price in CHF 1 pc. 24.90 ea. from 3 pcs. 22.90 ea. from 10 pcs. 19.90 ea.</p>	<p>The star made of 250 sparkling Swarovski elements is not just for superstars but looks also nice on your refrigerator.</p>
<p><b>LIV-54</b> Decorative magnet 'Starfish', holds approx. 400 g made of acrylic glass with Swarovski crystals Weight: 9 g strength: approx. 400 g</p>	<p>Price in CHF 1 pc. 24.90 ea. from 3 pcs. 22.90 ea. from 10 pcs. 19.90 ea.</p>	<p>The starfish made of 300 Swarovski elements is not just for superstars, but also looks good on your refrigerator.</p>
<p><b>LIV-55</b> Decorative magnet 'Glitter Heart', holds approx. 450 g made of acrylic glass with Swarovski crystals Weight: 17 g strength: approx. 450 g</p>	<p>Price in CHF 1 pc. 24.90 ea. from 3 pcs. 22.90 ea. from 10 pcs. 19.90 ea.</p>	<p>The heart made of sparkling Swarovski diamonds is not just a classy eye-catcher, it also holds paper love notes. Heart-shaped.</p>

<p><b>LIV-14</b> Magnetic marbles, holds approx. 500 g colourful deco magnets made of acrylic glass set of 6 Weight: 35 g/set strength: approx. 500 g</p>	<p>Price in CHF 1 set 9.90/set</p>	<p>They look like marbles but don't roll away thanks to the embedded magnet: Acrylic glass spheres in a set of 6.</p>
<p><b>LIV-05</b> Fridge magnets 'Crazy', holds approx. 300 g colourful deco magnets made of acrylic glass set of 6 Weight: 31 g/set strength: approx. 300 g</p>	<p>Price in CHF 1 set 9.90/set</p>	<p>With every set you receive six magnetic buttons with a little psychedelic touch.</p>
<p><b>LIV-157</b> Decorative magnets 'Cube Medium', holds approx. 300 g edge length 7 mm set of 6 silver-blue Weight: 46 g/set strength: approx. 300 g</p>	<p>Price in CHF 1 set 16.90/set</p>	<p>The decorative magnets "Cube Medium" by Trendform are something quite special. They reliably hold your notes not only on whiteboards and metal strips but on magnetic glass boards too.</p>
<p><b>LIV-158</b> Decorative magnets 'Bolt', holds approx. 200 g Ø 7 mm set of 6 silver-blue Weight: 40 g/set strength: approx. 200 g</p>	<p>Price in CHF 1 set 16.90/set</p>	<p>These compact decorative magnets by Trendform are not only practical but also truly eye-catching, thanks to their silver-blue, slightly shimmering colour.</p>
<p><b>LIV-159</b> Decorative magnets 'Kubiq', holds approx. 200 g edge length 5 mm set of 10 silver-blue Weight: 31 g/set strength: approx. 200 g</p>	<p>Price in CHF 1 set 9.90/set</p>	<p>Add a subtle splash of colour to your magnetic board with these small decorative magnets called "Kubiq". The silver-blue magnetic cubes safely hold notes, A4-sheets, postcards etc.</p>
<p><b>LIV-160</b> Decorative magnets 'Magnum', holds approx. 100 g Ø 4 mm set of 10 silver-blue Weight: 28 g/set strength: approx. 100 g</p>	<p>Price in CHF 1 set 9.90/set</p>	<p>These mini magnets in silver-blue are practical accessories to have in your office or home. Despite their small size, they still possess an astonishing 100 g adhesive force.</p>
<p><b>AG-04</b> Decorative magnets 'Winter Flowers', holds approx. 1.3 kg hand-crafted flower magnets in winter colours made of acrylic glass set of 5 Weight: 25 g/set strength: approx. 1.3 kg</p>	<p>Price in CHF 1 set 17.00/set from 3 sets 15.75/set from 10 sets 14.65/set</p>	<p>The Pril flowers of the new Millenium are made of acrylic glass - transparent and very magnetic. No better way to post your yoga appointments on the refrigerator! UV-resistant.</p>
<p><b>AG-03</b> Decorative magnets 'Summer Flowers', holds approx. 1.3 kg hand-crafted flower magnets in summer colours made of acrylic glass set of 5 Weight: 25 g/set strength: approx. 1.3 kg</p>	<p>Price in CHF 1 set 17.00/set from 3 sets 15.75/set from 10 sets 14.65/set</p>	<p>Cute flower magnets in bright summer colours. Each flower is unique and cut individually by hand. With an adhesive force of more than 1 kg, these magnets are strong enough to hold thicker paper or postcards. Each set contains 5 flower magnets. UV-resistant.</p>

## School magnets and accessories: Ferrofluid, horseshoe magnets & more for

Here you can find everything for physics class: Horseshoe magnets in various sizes, ferro fluid, iron filings, magnetic field detectors, etc.

<p><b>M-FER-10</b> Ferrofluid 10 ml magnetic fluid for experiments in PET bottle with pipette Weight: 36 g</p>	<p>Price in CHF</p> <p>1 pc. 12.95 ea. (1295.00/litre)</p> <p>from 3 pcs. 11.95 ea. (1195.00/litre)</p> <p>from 10 pcs. 11.05 ea. (1105.00/litre)</p>	<p>A ferrofluid is a liquid containing very small ferromagnetic particles. Because of these particles the liquid reacts strongly to magnetic fields and behaves strangely inside a magnetic field.</p>
<p><b>EDU-7</b> Bar magnet rectangular short 60 x 15 mm school magnet made of AlNiCo5 red-green coated Weight: 37 g</p>	<p>Price in CHF</p> <p>1 pc. 6.45 ea.</p> <p>from 3 pcs. 5.75 ea.</p> <p>from 10 pcs. 5.05 ea.</p> <p>from 20 pcs. 4.75 ea.</p> <p>from 40 pcs. 4.45 ea.</p>	<p>The small AlNiCo bar is 60 mm x 15 mm x 6 mm big and red-green coated. This magnet is suitable to demonstrate the magnetic field of an oblong magnet. The poles lie on the small areas with 15 mm x 6 mm.</p>
<p><b>EDU-8</b> Bar magnet rectangular long 100 x 15 mm school magnet made of AlNiCo5 red-green coated Weight: 110 g</p>	<p>Price in CHF</p> <p>1 pc. 13.95 ea.</p> <p>from 3 pcs. 12.50 ea.</p> <p>from 10 pcs. 11.20 ea.</p> <p>from 20 pcs. 10.55 ea.</p> <p>from 40 pcs. 10.00 ea.</p>	<p>The long AlNiCo bar is 100 mm x 15 mm x 10 mm big and red-green coated. This magnet is suitable to demonstrate the magnetic field of an oblong magnet. The poles lie on the small areas with 15 mm x 10 mm.</p>
<p><b>EDU-9</b> Rod magnet round 150 x 12 mm school magnet made of AlNiCo5 red-green coated Weight: 120 g</p>	<p>Price in CHF</p> <p>1 pc. 17.00 ea.</p> <p>from 3 pcs. 15.20 ea.</p> <p>from 10 pcs. 13.65 ea.</p> <p>from 20 pcs. 12.85 ea.</p> <p>from 40 pcs. 12.20 ea.</p>	<p>The long AlNiCo rod is 12 mm x 150 mm long and red-green coated. This magnet is suitable to demonstrate the magnetic field of an oblong magnet. The poles lie on the small circular areas.</p>
<p><b>EDU-3</b> Horseshoe magnet small 50 x 40 mm school magnet made of AlNiCo5 red-green coated Weight: 62 g</p>	<p>Price in CHF</p> <p>1 pc. 13.85 ea.</p> <p>from 3 pcs. 12.10 ea.</p> <p>from 10 pcs. 10.60 ea.</p> <p>from 20 pcs. 9.85 ea.</p> <p>from 40 pcs. 9.20 ea.</p>	<p>The small AlNiCo horseshoe magnet is 50 mm x 40 mm big and red-green coated. These classic horseshoe style magnets are popular in school experiments.</p>
<p><b>EDU-4</b> Horseshoe magnet medium 80 x 60 mm school magnet made of AlNiCo5 red-green coated Weight: 170 g</p>	<p>Price in CHF</p> <p>1 pc. 21.45 ea.</p> <p>from 3 pcs. 19.30 ea.</p> <p>from 10 pcs. 17.40 ea.</p> <p>from 20 pcs. 16.50 ea.</p> <p>from 40 pcs. 15.70 ea.</p>	<p>The medium AlNiCo horseshoe magnet is 80 mm x 60 mm big and red-green coated. You can do various experiments with these classic horseshoe style magnets.</p>
<p><b>EDU-5</b> Horseshoe magnet big 100 x 63 mm school magnet made of AlNiCo5 red-green coated Weight: 180 g</p>	<p>Price in CHF</p> <p>1 pc. 21.95 ea.</p> <p>from 3 pcs. 19.80 ea.</p> <p>from 10 pcs. 17.85 ea.</p> <p>from 20 pcs. 16.90 ea.</p> <p>from 40 pcs. 16.10 ea.</p>	<p>This big AlNiCo horseshoe magnet is 100 mm x 63 mm big and red-green coated. A classic magnet for educational use.</p>
<p><b>EDU-6</b> Horseshoe magnet tapered 100 x 48 mm school magnet made of AlNiCo5 red-green coated Weight: 110 g</p>	<p>Price in CHF</p> <p>1 pc. 18.75 ea.</p> <p>from 3 pcs. 16.85 ea.</p> <p>from 10 pcs. 15.10 ea.</p> <p>from 20 pcs. 14.25 ea.</p> <p>from 40 pcs. 13.50 ea.</p>	<p>This bent AlNiCo horseshoe magnet is 100 mm x 48 mm big (at the widest spot) and red-green coated. As opposed to our other three horseshoe magnets, the arms of this magnet are not parallel and the ends of the poles are closer together.</p>

<p><b>M-38</b> Letters or numbers magnetic set of magnetic symbols made of foam 4 assorted colours Weight: 350 g/set</p>	<p>Price in CHF 1 set 19.00/set</p>	<p>Each box of magnetic letters and numbers contains approx. 100 foam symbols, which contain a magnetic sheet on the back that makes them adhere to metal surfaces, such as blackboards and whiteboards and even magnetic paint.</p>
<p><b>M-22</b> Iron filings to make magnetic field lines visible approx. 100 g in a plastic container Weight: 100 g</p>	<p>Price in CHF 1 pc. 8.50 ea. from 3 pcs. 7.60 ea. from 10 pcs. 6.75 ea. from 20 pcs. 6.35 ea. from 40 pcs. 6.00 ea.</p>	<p>Iron filings are the simplest medium to use in making magnetic fields visible. You will receive approx. 100 g in a reclosable plastic container, as pictured.</p>
<p><b>ST-K-08-N</b> Steel balls Ø 8 mm not magnets! ferromagnetic, nickel-plated Weight: 2.1 g</p>	<p>Price in CHF 10 pcs. 0.29 ea. from 40 pcs. 0.24 ea. from 80 pcs. 0.22 ea. from 160 pcs. 0.21 ea.</p>	<p>These are NOT magnets, but nickel-plated steel balls. For combining with other magnets, e.g., with rod magnets.</p>
<p><b>ST-K-10-N</b> Steel balls Ø 10 mm not magnets! ferromagnetic, nickel-plated Weight: 4.2 g</p>	<p>Price in CHF 10 pcs. 0.28 ea. from 40 pcs. 0.24 ea. from 80 pcs. 0.22 ea. from 160 pcs. 0.21 ea.</p>	<p>These are NOT magnets, but nickel-plated steel balls. For combining with other magnets, e.g., with rod magnets.</p>
<p><b>ST-K-13-N</b> Steel balls Ø 12.7 mm not magnets! ferromagnetic, nickel-plated Weight: 8.5 g</p>	<p>Price in CHF 10 pcs. 0.36 ea. from 40 pcs. 0.31 ea. from 80 pcs. 0.30 ea. from 160 pcs. 0.28 ea.</p>	<p>These are NOT magnets, but nickel-plated steel balls. For combining with other magnets, e.g., with rod magnets.</p>
<p><b>ST-K-20-N</b> Steel balls Ø 20 mm not magnets! ferromagnetic, nickel-plated Weight: 33 g</p>	<p>Price in CHF 10 pcs. 0.96 ea. from 40 pcs. 0.80 ea. from 80 pcs. 0.73 ea. from 160 pcs. 0.67 ea.</p>	<p>These are NOT magnets, but nickel-plated steel balls. For combining with other magnets, e.g., with rod magnets.</p>
<p><b>M-37</b> Metal discs 35 x 2 mm not magnets! ferromagnetic, nickel-plated set of 20 Weight: 290 g/set</p>	<p>Price in CHF 1 set 7.20/set from 3 sets 6.50/set from 10 sets 5.80/set from 20 sets 5.45/set from 40 sets 5.05/set</p>	<p>20 solid iron metal discs. The metal discs are not magnetic, but a magnet adheres very well to these metal discs. The discs are nickel-plated so they won't rust.</p>
<p><b>M-04</b> Flux detector small foil to indicate magnetic fields approx. 75 x 75 mm Weight: 1 g</p>	<p>Price in CHF 1 pc. 7.60 ea. from 3 pcs. 6.75 ea. from 10 pcs. 6.00 ea. from 20 pcs. 5.65 ea. from 40 pcs. 5.30 ea.</p>	<p>This Flux Detector makes magnetic fields visible. It's accomplished by a foil filled with nickel particles in a gelatinous suspension. (see also M-05 and M-08.) Other sizes upon request.</p>
<p><b>M-05</b> Flux Detector laminated foil to indicate magnetic fields approx. 75 x 75 mm Weight: 3 g</p>	<p>Price in CHF 1 pc. 8.90 ea. from 3 pcs. 7.90 ea. from 10 pcs. 7.05 ea. from 20 pcs. 6.60 ea. from 40 pcs. 6.25 ea.</p>	<p>The same Flux Detector as Flux detector small, but laminated. This makes the foil less susceptible to cracking but stiffer, so it can no longer be wrapped around magnet systems.</p>

**M-08**

Flux Detector large  
foil to indicate magnetic  
fields  
approx. 150 x 150 mm  
Weight: 4 g

Price in CHF

	1 pc.	20.00 ea.
from	3 pcs.	18.05 ea.
from	10 pcs.	16.25 ea.
from	20 pcs.	15.35 ea.
from	40 pcs.	14.60 ea.

Same article as Flux detector small but with 4 times the surface area. The Flux Detector turns dark in colour when the magnetic field is perpendicular to the foil (for example, near the poles) and turns lighter when the magnetic field runs parallel to the foil.

## Magnetic name badges: needle-free attaching

Magnetic name tags have a clear advantage over others that require needles: The clothing won't be damaged and the tags are held in place securely thanks to super magnets. Magnetic name tags are therefore the perfect companion for weddings, congresses or other festive events.

<p><b>M-35</b> Name badge magnetic with card holder made of PET including magnet and blank insert set of 10 Weight: 180 g/set</p>	<p>Price in CHF</p> <table> <tr> <td></td> <td>1 set</td> <td>20.20/set</td> </tr> <tr> <td>from</td> <td>3 sets</td> <td>17.50/set</td> </tr> <tr> <td>from</td> <td>10 sets</td> <td>15.05/set</td> </tr> </table>		1 set	20.20/set	from	3 sets	17.50/set	from	10 sets	15.05/set	<p>At a conference, wedding or birthday party - with this name badge your clients and guests will look their best. This name tag is easy to attach, protects the clothing and assures strong adhesion.</p>						
	1 set	20.20/set															
from	3 sets	17.50/set															
from	10 sets	15.05/set															
<p><b>M-17</b> Name badge magnetic set for fastening a name badge 2 parts Weight: 12 g</p>	<p>Price in CHF</p> <table> <tr> <td></td> <td>5 pcs.</td> <td>1.70 ea.</td> </tr> <tr> <td>from</td> <td>15 pcs.</td> <td>1.40 ea.</td> </tr> <tr> <td>from</td> <td>40 pcs.</td> <td>1.20 ea.</td> </tr> <tr> <td>from</td> <td>80 pcs.</td> <td>1.15 ea.</td> </tr> </table>		5 pcs.	1.70 ea.	from	15 pcs.	1.40 ea.	from	40 pcs.	1.20 ea.	from	80 pcs.	1.15 ea.	<p>The quick solution for magnetic name tags of all kinds - the set spares your clothing since you don't need needles. - Simple assembly, thanks to the existing self-adhesive film - Comfortable to wear (only 12 grammes) - Not suitable for people with pacemakers!</p>			
	5 pcs.	1.70 ea.															
from	15 pcs.	1.40 ea.															
from	40 pcs.	1.20 ea.															
from	80 pcs.	1.15 ea.															
<p><b>M-34</b> Blank business cards Avery Zweckform C32011 for magnetic name badges package of 10 sheets Weight: 200 g</p>	<p>Price in CHF</p> <table> <tr> <td></td> <td>1 pc.</td> <td>11.30 ea.</td> </tr> <tr> <td>from</td> <td>3 pcs.</td> <td>10.45 ea.</td> </tr> <tr> <td>from</td> <td>10 pcs.</td> <td>9.65 ea.</td> </tr> <tr> <td>from</td> <td>20 pcs.</td> <td>9.30 ea.</td> </tr> <tr> <td>from</td> <td>40 pcs.</td> <td>8.95 ea.</td> </tr> </table>		1 pc.	11.30 ea.	from	3 pcs.	10.45 ea.	from	10 pcs.	9.65 ea.	from	20 pcs.	9.30 ea.	from	40 pcs.	8.95 ea.	<p>For quick, individual and professional printing of business-card-size cards. Suitable for laser and inkjet printer, makes 100 business cards.</p>
	1 pc.	11.30 ea.															
from	3 pcs.	10.45 ea.															
from	10 pcs.	9.65 ea.															
from	20 pcs.	9.30 ea.															
from	40 pcs.	8.95 ea.															



## The photo rope - a decorative magnetic hanging photo display

Most photo ropes feature a steel weight and are hung vertically. Products FL-04, FL-05 and FL-06, on the other hand, have two loops and are normally hung horizontally between two nails.

<p><b>FL-02</b> Photo rope 1.5 with weight steel cable with loop and steel weight incl. 15 magnets Weight: 150 g</p>	<p>Price in CHF</p> <p>1 pc. 18.50 ea.</p> <p>from 3 pcs. 16.65 ea.</p> <p>from 10 pcs. 15.00 ea.</p> <p>from 20 pcs. 14.15 ea.</p> <p>from 40 pcs. 13.45 ea.</p>	<p>This photo rope guarantees a stylish presentation of photos and postcards. A heavy and sturdy steel weight keeps the 2 mm thick steel wire perpendicular.</p>
<p><b>FL-14</b> Photo rope 'Pearly' 1.5 m steel cable with 2 loops incl. 10 magnets Weight: 130 g</p>	<p>Price in CHF</p> <p>1 pc. 14.90 ea.</p> <p>from 3 pcs. 13.40 ea.</p> <p>from 10 pcs. 12.05 ea.</p> <p>from 20 pcs. 11.40 ea.</p> <p>from 40 pcs. 10.85 ea.</p>	<p>Decorative "pearl" photo rope, 1.5 m, with 2 loops for easy mounting. Includes 10 small neodymium sphere magnets.</p>
<p><b>FL-05</b> Photo rope 2 m steel cable with 2 loops incl. 20 magnets Weight: 77 g</p>	<p>Price in CHF</p> <p>1 pc. 14.35 ea.</p> <p>from 3 pcs. 12.85 ea.</p> <p>from 10 pcs. 11.50 ea.</p> <p>from 20 pcs. 10.90 ea.</p> <p>from 40 pcs. 10.30 ea.</p>	<p>2 m long photo rope with 2 loops This version of the photo display wire has a loop on both ends but no steel weight. It can be hung horizontally on two nails or screws.</p>
<p><b>FL-04</b> Photo rope 1 m steel cable with 2 loops incl. 10 magnets Weight: 54 g</p>	<p>Price in CHF</p> <p>1 pc. 11.75 ea.</p> <p>from 3 pcs. 10.50 ea.</p> <p>from 10 pcs. 9.40 ea.</p> <p>from 20 pcs. 8.85 ea.</p> <p>from 40 pcs. 8.40 ea.</p>	<p>1 m long photo rope with 2 loops This version of the photo display wire has a loop on both ends but no steel weight. It can be hung horizontally on two nails or screws.</p>
<p><b>FL-03</b> Photo rope 2 m with weight steel cable with loop and steel weight incl. 20 magnets Weight: 160 g</p>	<p>Price in CHF</p> <p>1 pc. 19.70 ea.</p> <p>from 3 pcs. 17.75 ea.</p> <p>from 10 pcs. 15.95 ea.</p> <p>from 20 pcs. 15.10 ea.</p> <p>from 40 pcs. 14.35 ea.</p>	<p>This version of the photo rope is 2 m long and offers even more room for photos and postcards.</p>
<p><b>FL-06</b> Photo rope 3 m steel cable with 2 loops incl. 30 magnets Weight: 93 g</p>	<p>Price in CHF</p> <p>1 pc. 16.75 ea.</p> <p>from 3 pcs. 15.05 ea.</p> <p>from 10 pcs. 13.55 ea.</p> <p>from 20 pcs. 12.80 ea.</p> <p>from 40 pcs. 12.15 ea.</p>	<p>3 m long photo rope with 2 loops This version of the photo display wire has a loop on both ends but no steel weight.</p>
<p><b>FL-10</b> Photo rope 'Sweetheart' 1.5 m steel cable with loop and steel weight incl. 8 heart magnets Weight: 70 g</p>	<p>Price in CHF</p> <p>1 pc. 14.90 ea.</p> <p>from 3 pcs. 13.40 ea.</p> <p>from 10 pcs. 12.05 ea.</p> <p>from 20 pcs. 11.40 ea.</p> <p>from 40 pcs. 10.85 ea.</p>	<p>1,5 m long photo rope with 8 cute and magnetic metal hearts. For the sweetest photos and cards!</p>
<p><b>FL-08</b> Photo rope 'Kitty Cat' 1.5 m steel cable with loop and steel weight incl. 8 cat magnets Weight: 74 g</p>	<p>Price in CHF</p> <p>1 pc. 14.90 ea.</p> <p>from 3 pcs. 13.40 ea.</p> <p>from 10 pcs. 12.05 ea.</p> <p>from 20 pcs. 11.40 ea.</p> <p>from 40 pcs. 10.85 ea.</p>	<p>A must-have for cat lovers. Delivery includes eight little cat magnets and a 1.5 m long steel wire with weight.</p>

<b>FL-12</b> Photo rope 'Timi' 1.5 m steel cable with loop and steel weight length 1.5 m incl. 8 little sheep magnets Weight: 74 g	Price in CHF 1 pc. 14.90 ea. from 3 pcs. 13.40 ea. from 10 pcs. 12.05 ea. from 20 pcs. 11.40 ea. from 40 pcs. 10.85 ea.	The 8 sheep on this photo rope hold your favourite photos securely in the place.
<b>FL-13</b> Photo rope 'Star' 1.5 m steel cable with loop and steel weight incl. 8 star magnets Weight: 84 g	Price in CHF 1 pc. 14.90 ea. from 3 pcs. 13.40 ea. from 10 pcs. 12.00 ea. from 20 pcs. 11.35 ea. from 40 pcs. 10.75 ea.	The 8 stars of this photo rope hold your favourite photos securely in place.
<b>FL-09</b> Photo rope 'Kolor Klip' 1.5 m steel cable with two loops incl. 10 pins not magnetic! Weight: 16 g	Price in CHF 1 pc. 14.90 ea. from 3 pcs. 13.45 ea. from 10 pcs. 12.65 ea. from 20 pcs. 11.55 ea. from 40 pcs. 10.95 ea.	You probably won't be able to hang up laundry on these colourful wooden pegs, but postcards, love notes and recipes instead. Please note: This photo rope does not come with magnets!

## Picture frames with magnetic catch

<b>FRM-10</b> Magnetic picture frame 21 x 15 cm photo frame with magnetic catch made of transparent acrylic glass for portrait or landscape format Weight: 1.1 kg	Price in CHF 1 pc. 35.90 ea.	The same picture frame as Magnetic picture frame 18 x 13 cm, but larger and therefore suitable for photos up to 21.1 x 14.9 cm (DIN A5).
<b>FRM-03</b> Magnetic picture frame 18 x 13 cm photo frame with magnetic catch made of transparent acrylic glass for portrait or landscape format Weight: 830 g	Price in CHF 1 pc. 27.40 ea.	The same picture frame as Magnetic picture frame 11.5 x 9 cm, but bigger and therefore suitable for pictures of up to 17.8 x 12.7 cm.
<b>FRM-02</b> Magnetic picture frame 15 x 11.5 cm photo frame with magnetic catch made of transparent acrylic glass for portrait or landscape format Weight: 510 g	Price in CHF 1 pc. 16.80 ea.	The same picture frame as Magnetic picture frame 11.5 x 9 cm, but bigger and therefore suitable for pictures of up to 15 x 11.5 cm.
<b>FRM-01</b> Magnetic picture frame 11.5 x 9 cm photo frame with magnetic catch made of transparent acrylic glass for portrait or landscape format Weight: 310 g	Price in CHF 1 pc. 12.10 ea.	This acrylic picture frame shows the best side of your pictures. Portrait or landscape format - the stable frame stands sturdy on its broad, polished sides. Thanks to the magnets sunk into the corners, the frame can be opened and closed in no time.
<b>FRM-09</b> Magnetic picture frame 7 x 5 cm photo frame with magnetic catch made of transparent acrylic glass for portrait or landscape format Weight: 90 g	Price in CHF 1 pc. 8.25 ea.	This acrylic picture frame shows the best side of your pictures. Portrait or landscape format - the stable frame stands sturdy on its broad, polished sides. Thanks to the magnets sunk into the corners, the frame can be opened and closed in no time.

## Magnetic key racks & key holder

Practical and original key holder to keep your keys and other small ferromagnetic objects. Modern keys are not magnetic, but the mailbox key or the keyring usually adhere well, which also 'glues' the rest of them to the holder.

<b>FO-1</b> Key rack magnetic 32 cm magnetic bar for storing keys made of stainless steel for 6 keys Weight: 160 g	Price in CHF 1 pc. 18.75 ea.	Magnetic key rack made of solid brushed stainless steel (1.5 mm thick). The usable surface is 32 x 3.5 cm. Installation parts included.
<b>FO-2</b> Key rack magnetic 50 cm magnetic bar for storing keys made of stainless steel for 11 keys Weight: 250 g	Price in CHF 1 pc. 22.65 ea.	The larger version of Key rack magnetic 32 cm. 50 instead of 32 cm long and with 11 magnetic docks for keys. Installation material (3 magnetic wall pins) is included.
<b>FO-3</b> Key rack magnetic 32 cm magnetic bar for storing keys made of pear wood for 6 keys Weight: 160 g	Price in CHF 1 pc. 17.80 ea.	Magnetic key rack made of solid oiled peartree wood.
<b>FO-7</b> Key rack magnetic extra strong for storing keys stainless steel, with felt coating for 8 keys Weight: 680 g	Price in CHF 1 pc. 49.90 ea.	Magnetic key rack in a league of its own. Eight powerful magnets on the back of the steel plate (25 x 15 cm) guarantee a rock-solid hold on your keys. Thanks to a black felt cover, even throwing keys at the rack from a distance will not damage it.

## Knife racks & knife blocks with strong magnetic power

Magnetic knife strips and magnetic knife blocks are nicely shaped and practical kitchen accessories. Knives adhere thanks to embedded neodymium magnets and don't have to be stored in the drawer anymore where they can easily become dull and scratched.

<p><b>FO-10</b> Knife rack magnetic 32 cm magnetic knife holder made of stainless steel for 6 knives up to 500 g Weight: 300 g</p>	<p>Price in CHF 1 pc. 25.30 ea.</p>	<p>Magnetic knife rack made of solid brushed V2A stainless steel (1.5 mm thick). The usable area is 32 x 3.5 cm. The mounting accessories are included in the delivery.</p>
<p><b>FO-11</b> Knife rack magnetic 50 cm magnetic knife holder made of stainless steel for 9 knives up to 500 g Weight: 400 g</p>	<p>Price in CHF 1 pc. 35.20 ea.</p>	<p>Magnetic knife rack made of solid brushed V2A stainless steel (1.5 mm thick). The usable area is 50 x 3.5 cm. The mounting accessories are included in the delivery.</p>
<p><b>M-KNIFEP-001</b> Knife rack magnetic 45 cm magnetic knife holder made of wood for 10 knives up to 500 g Weight: 590 g</p>	<p>Price in CHF 1 pc. 59.95 ea.</p>	<p>Carefully crafted and equipped with strong block magnets on the inside, these knife strips are real eye-catchers in the kitchen. One strip holds up to 10 knives.</p>
<p><b>M-KNIFEB-001</b> Knife block magnetic Modular magnetic knife holder made of wood for 10 knives up to 900 g Weight: 2.4 kg/set</p>	<p>Price in CHF 1 set 109.90/set from 3 sets 106.50/set</p>	<p>The modular knife block has three wooden parts and can be arranged however you choose. You can securely attach at least 10 knives with a weight of up to 900 g.</p>
<p><b>M-KNIFEB-002</b> Knife block magnetic Pentagon magnetic knife holder made of wood for 8 knives up to 900 g Weight: 1.8 kg</p>	<p>Price in CHF 1 pc. 86.50 ea.</p>	<p>Your knives seem to float on the "Pentagon". Thanks to the extremely strong embedded magnets, you can safely attach at least 8 knives with a weight of up to 900 g.</p>
<p><b>M-KNIFES-001</b> Breakfast board set cutting board made of beechwood with magnetic knife holder &amp; PanoramaKnife Weight: 370 g/set</p>	<p>Price in CHF 1 set 99.95/set</p>	<p>The perfect set for a breakfast, snack, picnic or hiking break. Features a breakfast knife and a beechwood board with magnetic knife holder, original by PanoramaKnife Switzerland.</p>

## Magnetic board - the multi-functional fancy pin board

Magnetic boards are the perfect presentation surface for postcards, drawings, etc. Many products include suitable neodymium magnets.

<p><b>GMBB-2060</b> Magnetic glass board rectangular magnetic board with glass surface, 20 x 60 cm in different colours Weight: 1.4 kg</p>	<p>Price in CHF 1 pc. 29.95 ea.</p>	<p>Rectangular magnetic glass board made of hardened safety glass. Can be attached with pre-assembled wall mounting on the backside. Wall mounting set and mounting instructions enclosed.</p>
<p><b>GMBB-4550</b> Magnetic glass board square magnetic board with glass surface, 45 x 50 cm in different colours Weight: 2.7 kg</p>	<p>Price in CHF 1 pc. 38.95 ea.</p>	<p>Square magnetic glass board made of hardened safety glass. Can be attached with pre-assembled wall mounting on the backside. Wall mounting set and mounting instructions enclosed.</p>
<p><b>SF-WC1-M</b> superflex magnetic wallpaper 10 m<sup>2</sup> white ferromagnetic Weight: 15 kg</p>	<p>Price in CHF 1 pc. 349.00 ea. from 3 pcs. 319.00 ea.</p>	<p>With this magnetic wallpaper, you can transform an ordinary wall into a practical magnetic surface. The magnetic wallpaper is ready for use just 48 hours after it has been applied.</p>
<p><b>MB-11</b> Magnetic board square magnetic noticeboard made of 0.8 mm thick steel sheet 40 x 40 cm in different colours Weight: 1.2 kg</p>	<p>Price in CHF 1 pc. 31.90 ea. from 3 pcs. 28.40 ea. from 10 pcs. 22.90 ea. from 20 pcs. 21.85 ea. from 40 pcs. 20.90 ea.</p>	<p>A classy square magnetic board, available in several styles: black or white powder coating or simply stainless steel.</p>
<p><b>FO-8</b> Magnetic board slate elegant and exclusive magnet noticeboard 40 x 20 cm incl. 10 strong magnets Weight: 2.2 kg</p>	<p>Price in CHF 1 pc. 40.00 ea.</p>	<p>Noble wall panel with blue-grey slate surface. 40 cm x 20 cm, made from slate from the Mosel river area, with character line (wall distance about 1 cm). Easy assembly, in portrait and landscape format. Every one of those pieces is unique.</p>
<p><b>FO-9</b> Stainless steel discs self-adhesive self-adhesive surface for magnets set of 10 Weight: 2 g/set</p>	<p>Price in CHF 1 set 5.75/set from 3 sets 5.00/set from 10 sets 4.35/set from 20 sets 4.00/set from 40 sets 3.75/set</p>	<p>The world's smallest magnetic board! 10 stainless steel discs, diameter 15 mm, height 0.4 mm with self-adhesive foil on the back side. Magnets are not included.</p>

## Magnetic paint for creative & magnetic wall decoration

With magnetic paint you can turn any surface into a magnetic wall. Paint the wall or the desired wall portion with magnetic paint at least two times. Then, paint over the grey magnetic paint with the paint of your choice. And there you have your own individual magnetic wall!

<p><b>M-MP-500</b> Magnetic paint S 0.5 litre magnetic wall paint grey for an area of 1–1.5 m<sup>2</sup> Weight: 1.2 kg</p>	<p>Price in CHF</p> <p>1 pc. 31.00 ea. (62.00/litre) from 3 pcs. 28.15 ea. (56.30/litre) from 10 pcs. 25.60 ea. (51.20/litre) from 20 pcs. 24.35 ea. (48.70/litre) from 40 pcs. 23.25 ea. (46.50/litre)</p>	<p>This magnetic paint is the latest rage! It transforms any surface into a magnetic wall, be it an actual wall or part of it, a door or a piece of furniture.</p>
<p><b>M-MP-1000</b> Magnetic paint M 1 litre magnetic wall paint grey for an area of 2–3 m<sup>2</sup> Weight: 2.4 kg</p>	<p>Price in CHF</p> <p>1 pc. 53.80 ea. (53.80/litre) from 3 pcs. 48.60 ea. (48.60/litre) from 10 pcs. 44.00 ea. (44.00/litre) from 20 pcs. 41.75 ea. (41.75/litre) from 40 pcs. 39.80 ea. (39.80/litre)</p>	<p>This magnetic paint is the latest rage! It transforms any surface into a magnetic wall, be it an actual wall or part of it, a door or a piece of furniture.</p>
<p><b>M-MP-2500</b> Magnetic paint L 2.5 litre magnetic wall paint grey for an area of 5–7.5 m<sup>2</sup> Weight: 6 kg</p>	<p>Price in CHF</p> <p>1 pc. 95.75 ea. (38.30/litre) from 3 pcs. 87.55 ea. (35.02/litre) from 10 pcs. 79.20 ea. (31.68/litre) from 20 pcs. 76.65 ea. (30.66/litre)</p>	<p>This magnetic paint is the latest rage! It transforms any surface into a magnetic wall, be it an actual wall or part of it, a door or a piece of furniture.</p>
<p><b>M-MP-4000</b> Magnetic paint XL 4 litre magnetic wall paint grey for an area of 8–12 m<sup>2</sup> Weight: 9.6 kg</p>	<p>Price in CHF</p> <p>1 pc. 136.15 ea. (34.04/litre) from 3 pcs. 125.15 ea. (31.29/litre) from 10 pcs. 115.30 ea. (28.83/litre) from 20 pcs. 110.55 ea. (27.64/litre)</p>	<p>This magnetic paint is the latest rage! It transforms any surface into a magnetic wall, be it an actual wall or part of it, a door or a piece of furniture.</p>
<p><b>SF-PL-5000</b> superflex magnetic plaster 10 kg black for a surface area of 6 m<sup>2</sup> Weight: 10 kg</p>	<p>Price in CHF</p> <p>1 pc. 129.00 ea. (25.80/kg) from 3 pcs. 119.00 ea. (23.80/kg) from 5 pcs. 109.00 ea. (21.80/kg)</p>	<p>Colour: Black Yield: 5 m<sup>2</sup> (two coats)</p>
<p><b>M-BP-SPRAY</b> Chalkboard varnish magnetic to spray on for a magnetic area of 0.5 m<sup>2</sup> Weight: 610 g</p>	<p>Price in CHF</p> <p>1 pc. 22.55 ea. (56.38/litre) from 3 pcs. 20.95 ea. (52.38/litre) from 10 pcs. 19.50 ea. (48.75/litre) from 20 pcs. 18.80 ea. (47.00/litre)</p>	<p>The blackboard varnish "Click &amp; Write" is a ferromagnetic blackboard spray paint. After treating the surface, you can write on the magnetic blackboard paint with chalk and wipe it down like a regular school blackboard.</p>

## Blackboard film and chalkboard paint

<p><b>CB-100500</b> Blackboard film 1 x 5 m self-adhesive ferromagnetic surface for magnets 1 x 5 m roll in different colours Weight: 8 kg</p>	<p>Price in CHF 1 pc. 127.90 ea.</p>	<p>Self-adhesive, slightly textured blackboard film, 1 x 5 m roll, in green and black. Can be written on with chalk and dry-erased afterwards. Perfect as a blackboard for schools, conference and seminar rooms, in the kitchen or children's room.</p>
<p><b>CB-4040</b> Blackboard film 40 x 40 cm self-adhesive ferromagnetic surface for magnets in different colours Weight: 250 g</p>	<p>Price in CHF 1 pc. 6.90 ea. from 3 pcs. 5.95 ea. from 10 pcs. 5.15 ea. from 20 pcs. 4.75 ea. from 40 pcs. 4.40 ea.</p>	<p>Self-adhesive, slightly textured blackboard film, 40 x 40 cm in green, sea-green (teal), black or grey. Can be written on with chalk and dry-erased afterwards. Perfect as a blackboard for the kitchen or children's room, as well as schools, conference and seminar rooms.</p>
<p><b>M-BP-375</b> Chalkboard paint S 375 ml for an area of 3 m<sup>2</sup> black or green not magnetic! Weight: 530 g</p>	<p>Price in CHF 1 pc. 12.80 ea. (34.13/litre) from 3 pcs. 11.85 ea. (31.60/litre) from 10 pcs. 11.00 ea. (29.33/litre) from 20 pcs. 10.55 ea. (28.13/litre)</p>	<p>The blackboard paint is a special varnish that creates surfaces you can write on with chalk. Available in black and green.</p>
<p><b>M-BP-750</b> Chalkboard paint L 750 ml for an area of 6 m<sup>2</sup> black or green not magnetic! Weight: 1 kg</p>	<p>Price in CHF 1 pc. 20.85 ea. (27.80/litre) from 3 pcs. 19.35 ea. (25.80/litre) from 10 pcs. 18.00 ea. (24.00/litre) from 20 pcs. 17.35 ea. (23.13/litre)</p>	<p>The blackboard paint is a special varnish that creates surfaces you can write on with chalk. Available in black and green.</p>



## Magnetic memo holders: beastly strong note holders

Thanks to neodymium magnets, these colourful magnetic memo holders stick together. Separate the magnetic animals and place a note, photo, business card, name tag, etc. in between. A cute and practical eye-catcher!

### **ANI-02**

Piggy  
magnetic memo holder Pig  
Weight: 63 g

Price in CHF  
1 pc. 3.90 ea.

Piglet Piggy looks at the world with the stoicism and calmness of a zen master, despite its not very diversified function as a memo holder.  
Get inspired!

## Whiteboard, whiteboard paint & whiteboard foil - the practical, wipeable writing and

<p><b>SF-OF1</b> superflex whiteboard sheet self-adhesive 10 m<sup>2</sup>, white dry-erase not a surface for magnets Weight: 6 kg</p>	<p>Price in CHF 1 pc. 269.00 ea. from 3 pcs. 249.00 ea.</p>	<p>The self-adhesive whiteboard sheet by superflex allows you to turn smooth surfaces such as tables, doors, partitions and other furniture into writing surfaces.</p>
<p><b>SF-WC2-MD</b> superflex 2-in-1 wallpaper 10 m<sup>2</sup> glossy white ferromagnetic, dry erase Weight: 15 kg</p>	<p>Price in CHF 1 pc. 599.00 ea. from 3 pcs. 579.00 ea. from 5 pcs. 549.00 ea.</p>	<p>Whiteboard and magnetic wallpaper in one. The 2-in-1 wallpaper can be written on with whiteboard markers. With magnets, documents, notes, plans, etc. can be attached to this wallcovering as well.</p>
<p><b>SF-WC3-MDP</b> superflex 3-in-1 wallpaper 10 m<sup>2</sup> matt white ferromagnetic, dry-erase, projection screen Weight: 15 kg</p>	<p>Price in CHF 1 pc. 699.00 ea. from 3 pcs. 669.00 ea. from 5 pcs. 629.00 ea.</p>	<p>superflex 3-in-1 wallpaper: whiteboard wallpaper, magnetic wallpaper and projection screen wallpaper in one. It transforms any wall into a high-performance surface and offers you many possible uses.</p>
<p><b>FS-100500MWBM</b> Whiteboard sheet ferromagnetic surface for magnets 1 x 5 m roll Weight: 8.2 kg</p>	<p>Price in CHF 1 pc. 116.75 ea.</p>	<p>With this glossy whiteboard sheet (a white iron sheet) you can turn an iron surface into a magnetic whiteboard in no time. Just cut the sheet to the desired size and attach it to an smooth surface (Please note: Sheet is not self-adhesive).</p>
<p><b>MWB-4560</b> Whiteboard 45 x 60 cm surface for magnets writable with chalk markers Weight: 1.3 kg</p>	<p>Price in CHF 1 pc. 34.90 ea.</p>	<p>A classic for sketching and planning: Even in these digital days, every conference room needs a whiteboard.</p>
<p><b>MWB-3045</b> Whiteboard 30 x 45 cm surface for magnets writable with chalk markers Weight: 770 g</p>	<p>Price in CHF 1 pc. 29.90 ea.</p>	<p>A classic for sketching and planning: Even in these digital days, every conference room needs a whiteboard.</p>
<p><b>KMWB-2435</b> Children's whiteboard 24 x 35 cm surface for magnets for drawing, playing, writing &amp; learning single-sided use Weight: 210 g</p>	<p>Price in CHF 1 pc. 5.85 ea.</p>	<p>For drawing, playing, writing and playing in school or at home - for children 3 years and up. Writable on one side.</p>
<p><b>M-WP-1000</b> Whiteboard paint L 1litre for an area of 6 m<sup>2</sup> white or transparent not magnetic! Weight: 1.2 kg</p>	<p>Price in CHF 1 pc. 97.95 ea. (97.95/litre) from 3 pcs. 92.95 ea. (92.95/litre) from 10 pcs. 88.45 ea. (88.45/litre) from 20 pcs. 85.65 ea. (85.65/litre)</p>	<p>Turn every smooth surface into a dry-wipe whiteboard - whether it is a large wall, a door, a cupboard or an old blackboard.</p>

<p><b>SF-ADH-001</b> superflex vinyl wallpaper paste special adhesive for superflex wallpapers and films for a surface area of approx. 20 m<sup>2</sup> Weight: 5 kg</p>	<p>Price in CHF 1 pc. 54.90 ea. (10.98/litre) from 3 pcs. 50.90 ea. (10.18/litre)</p>	<p>The superflex wallpaper paste is a special adhesive specifically developed for use with superflex wallpapers.</p>
<p><b>SF-PRI-001</b> superflex primer perfect for superflex products white, 750 ml for a surface area of approx. 6 m<sup>2</sup> Weight: 1.1 kg</p>	<p>Price in CHF 1 pc. 24.90 ea. (4.98/litre) from 3 pcs. 22.90 ea. (4.58/litre) from 5 pcs. 20.90 ea. (4.18/litre)</p>	<p>The superflex primer ensures that surfaces made of wood, plaster or metal are properly sealed. As a result, products such as magnetic plaster, magnetic wallpaper and film wallcoverings adhere well to the treated surface.</p>
<p><b>KMWB-2840</b> Children's whiteboard 28 x 40 cm surface for magnets for drawing, playing, writing &amp; learning usable on both sides Weight: 370 g</p>	<p>Price in CHF 1 pc. 12.05 ea.</p>	<p>For drawing, playing, writing and learning in school and at home - for children 3 years and up. Writable on both sides.</p>
<p><b>FS-100500MWBG-STIC</b> Whiteboard sheet self- adhesive ferromagnetic surface for magnets 1 x 5 m roll Weight: 8.2 kg</p>	<p>Price in CHF 1 pc. 127.90 ea.</p>	<p>With this self-adhesive whiteboard sheet you can easily make a whiteboard in no time. Simply cut the sheet to the desired size, remove the protective film and attach the sheet to a smooth surface.</p>
<p><b>M-WP-500</b> Whiteboard paint S 500 ml for an area of 3 m<sup>2</sup> white or transparent not magnetic! Weight: 670 g</p>	<p>Price in CHF 1 pc. 51.95 ea. (103.90/litre) from 3 pcs. 50.20 ea. (100.40/litre) from 10 pcs. 48.60 ea. (97.20/litre) from 20 pcs. 47.85 ea. (95.70/litre)</p>	<p>Turn every smooth surface into a dry-wipe whiteboard - whether it is a large wall, a door, a cupboard or an old blackboard.</p>
<p><b>DC-2A4</b> Display case 2 x A4 for 2 A4 sheets extra-flat design lockable Weight: 1.6 kg</p>	<p>Price in CHF 1 pc. 55.60 ea.</p>	<p>This display case is ideal to share information in apartment buildings, schools, companies, etc. The display window has room for 2 A4 sheets of paper next to each other. Thanks to the very flat design the case doesn't protrude into the room.</p>
<p><b>DC-4A4</b> Display case 4 x A4 for 4 A4 sheets extra-flat design lockable Weight: 2.4 kg</p>	<p>Price in CHF 1 pc. 102.30 ea.</p>	<p>This lockable display case is ideal to share information in apartment buildings, schools, companies, etc. The display window has room for 4 A4 sheets of paper next to each other. Thanks to the very flat design the case doesn't protrude into the room.</p>
<p><b>DC-6A4</b> Display case 6 x A4 for 6 A4 sheets extra-flat design lockable Weight: 3.7 kg</p>	<p>Price in CHF 1 pc. 135.50 ea.</p>	<p>This lockable display case is ideal to share information in apartment buildings, schools, companies, etc. The display window has room for 6 A4 sheets of paper next to each other. Thanks to the very flat design the case doesn't protrude into the room.</p>

## Whiteboard accessories: Practical equipment for office and school

Here you can find everything you need for working on a whiteboard: Whiteboard markers to write-on or draw, magnetic dry eraser & marker holder, as well as coloured and white chalk. The whiteboard markers and chalk markers can also be used for magnetic glass boards.

<p><b>BA-021</b> Chalk pens liquid chalk for magnetic glass boards and whiteboards in different colours set of 4 Weight: 100 g/set</p>	<p>Price in CHF 1 set 14.95/set</p>	<p>The chalk pens of the uni brand come in a set of 4 and are ideal for writing on smooth surfaces such as boards, windows, glass, plastic, and metal.</p>
<p><b>MP-A4</b> Magnetic pouch A4 for office and workshop A4 format in different colours Weight: 250 g</p>	<p>Price in CHF 1 pc. 4.70 ea. from 3 pcs. 4.20 ea. from 10 pcs. 3.75 ea. from 20 pcs. 3.50 ea. from 40 pcs. 3.35 ea.</p>	<p>Transparent, soft magnetic pouch in A4 format, attached to a strong magnetic sheet. The ideal organiser for office, workshop, warehouse, or kitchen.</p>
<p><b>MP-A5</b> Magnetic pouch A5 for office and workshop A5 format in different colours Weight: 85 g</p>	<p>Price in CHF 1 pc. 3.50 ea. from 3 pcs. 3.10 ea. from 10 pcs. 2.75 ea. from 20 pcs. 2.60 ea. from 40 pcs. 2.45 ea.</p>	<p>Transparent, soft magnetic pouch in A5 format, attached to a strong magnetic sheet. The ideal organiser for office, workshop, warehouse, or kitchen.</p>
<p><b>BA-017</b> Whiteboard cleaner cleaning spray for whiteboards in a plastic pump bottle 250 ml Weight: 280 g</p>	<p>Price in CHF 1 pc. 9.95 ea. (39.80/litre)</p>	<p>Whiteboard cleaner, 250 ml spray bottle. For a thorough cleaning of whiteboards, magnetic glass boards, and other writeable surfaces.</p>
<p><b>BA-016</b> Magnet symbols Smiley Smiley magnets for whiteboards &amp; planning boards 6 smileys per A5 sheet set of 3: green, yellow, red Weight: 370 g/set</p>	<p>Price in CHF 1 set 7.70/set from 3 sets 6.60/set from 10 sets 5.65/set from 20 sets 5.20/set from 40 sets 4.80/set</p>	<p>Large magnetic smiley symbols in three colours and moods. Made of colourful magnetic sheets they serve as eye-catchers or to highlight content on whiteboards and other magnetic surfaces.</p>
<p><b>BA-014AR</b> Magnetic symbols Arrow large magnetic arrows for whiteboards &amp; planning boards, write-on 8 symbols per A4 sheet in different colours Weight: 240 g/set</p>	<p>Price in CHF 1 set 3.90/set from 3 sets 3.40/set from 10 sets 2.95/set from 20 sets 2.70/set from 40 sets 2.50/set</p>	<p>Large magnetic arrow symbols in various colours serve as eye-catchers or to highlight content on whiteboards and other magnetic surfaces.</p>
<p><b>BA-014CI</b> Magnetic symbols Circle large magnetic circles for whiteboards &amp; planning boards, write-on 12 symbols per A4 sheet in different colours Weight: 240 g/set</p>	<p>Price in CHF 1 set 3.90/set from 3 sets 3.40/set from 10 sets 2.95/set from 20 sets 2.70/set from 40 sets 2.50/set</p>	<p>Large magnetic circle symbols in various colours serve as eye-catchers or to highlight content on whiteboards and other magnetic surfaces.</p>
<p><b>BA-014BO</b> Magnetic symbols Speech Bubble, oval magnetic speech bubbles for whiteboards &amp; planning boards, write-on 10 symbols per A4 sheet in different colours Weight: 240 g/set</p>	<p>Price in CHF 1 set 3.90/set from 3 sets 3.40/set from 10 sets 2.95/set from 20 sets 2.70/set from 40 sets 2.50/set</p>	<p>Magnetic oval speech bubble symbols made of colourful magnetic sheets serve as eye-catchers or to highlight content on whiteboards and other magnetic surfaces.</p>

<p><b>BA-014BR</b> Magnetic symbols Speech Bubble, rectangular magnetic speech bubbles for whiteboards &amp; planning boards, write-on 10 symbols per A4 sheet in different colours Weight: 240 g/set</p>	<p>Price in CHF</p> <table> <tr><td>1 set</td><td>3.90/set</td></tr> <tr><td>from 3 sets</td><td>3.40/set</td></tr> <tr><td>from 10 sets</td><td>2.95/set</td></tr> <tr><td>from 20 sets</td><td>2.70/set</td></tr> <tr><td>from 40 sets</td><td>2.50/set</td></tr> </table>	1 set	3.90/set	from 3 sets	3.40/set	from 10 sets	2.95/set	from 20 sets	2.70/set	from 40 sets	2.50/set	<p>Magnetic rectangular speech bubble symbols made of colourful magnetic sheets serve as eye-catchers or to highlight content on whiteboards and other magnetic surfaces.</p>
1 set	3.90/set											
from 3 sets	3.40/set											
from 10 sets	2.95/set											
from 20 sets	2.70/set											
from 40 sets	2.50/set											
<p><b>BA-014CL</b> Magnetic symbols Cloud magnetic clouds for whiteboards &amp; planning boards, write-on 10 symbols per A4 sheet in different colours Weight: 240 g/set</p>	<p>Price in CHF</p> <table> <tr><td>1 set</td><td>3.90/set</td></tr> <tr><td>from 3 sets</td><td>3.40/set</td></tr> <tr><td>from 10 sets</td><td>2.95/set</td></tr> <tr><td>from 20 sets</td><td>2.70/set</td></tr> <tr><td>from 40 sets</td><td>2.50/set</td></tr> </table>	1 set	3.90/set	from 3 sets	3.40/set	from 10 sets	2.95/set	from 20 sets	2.70/set	from 40 sets	2.50/set	<p>Large magnetic cloud symbols made of colourful magnetic sheets serve as eye-catchers or to highlight content on whiteboards and other magnetic surfaces.</p>
1 set	3.90/set											
from 3 sets	3.40/set											
from 10 sets	2.95/set											
from 20 sets	2.70/set											
from 40 sets	2.50/set											
<p><b>BA-014TR</b> Magnetic symbols Triangle large magnetic triangles for whiteboards &amp; planning boards, write-on 25 symbols per A4 sheet in different colours Weight: 240 g/set</p>	<p>Price in CHF</p> <table> <tr><td>1 set</td><td>3.90/set</td></tr> <tr><td>from 3 sets</td><td>3.40/set</td></tr> <tr><td>from 10 sets</td><td>2.95/set</td></tr> <tr><td>from 20 sets</td><td>2.70/set</td></tr> <tr><td>from 40 sets</td><td>2.50/set</td></tr> </table>	1 set	3.90/set	from 3 sets	3.40/set	from 10 sets	2.95/set	from 20 sets	2.70/set	from 40 sets	2.50/set	<p>Large magnetic triangle symbols made of colourful magnetic sheets serve as eye-catchers or to highlight content on whiteboards and other magnetic surfaces.</p>
1 set	3.90/set											
from 3 sets	3.40/set											
from 10 sets	2.95/set											
from 20 sets	2.70/set											
from 40 sets	2.50/set											
<p><b>BA-014RE</b> Magnetic symbols Rectangle large magnetic rectangles for whiteboards &amp; planning boards, write-on 10 symbols per A4 sheet in different colours Weight: 240 g/set</p>	<p>Price in CHF</p> <table> <tr><td>1 set</td><td>3.90/set</td></tr> <tr><td>from 3 sets</td><td>3.40/set</td></tr> <tr><td>from 10 sets</td><td>2.95/set</td></tr> <tr><td>from 20 sets</td><td>2.70/set</td></tr> <tr><td>from 40 sets</td><td>2.50/set</td></tr> </table>	1 set	3.90/set	from 3 sets	3.40/set	from 10 sets	2.95/set	from 20 sets	2.70/set	from 40 sets	2.50/set	<p>Large magnetic rectangle symbols made of colourful magnetic sheets serve as eye-catchers or to highlight content on whiteboards and other magnetic surfaces.</p>
1 set	3.90/set											
from 3 sets	3.40/set											
from 10 sets	2.95/set											
from 20 sets	2.70/set											
from 40 sets	2.50/set											
<p><b>BA-012A</b> Magnetic symbols Arrow small magnetic arrows for whiteboards &amp; planning boards 30 symbols per sheet in different colours Weight: 47 g</p>	<p>Price in CHF</p> <table> <tr><td>1 pc.</td><td>5.95 ea.</td></tr> </table>	1 pc.	5.95 ea.	<p>Coloured small magnetic arrow symbols are eye-catchers and can be used to mark whiteboard content.</p>								
1 pc.	5.95 ea.											
<p><b>BA-012R</b> Magnetic symbols Rectangle small magnetic rectangles for whiteboards &amp; planning boards 56 symbols per sheet in different colours Weight: 47 g</p>	<p>Price in CHF</p> <table> <tr><td>1 pc.</td><td>5.95 ea.</td></tr> </table>	1 pc.	5.95 ea.	<p>Coloured small magnetic rectangular symbols are eye-catchers and can be used for marking content on whiteboards and other magnetic surfaces.</p>								
1 pc.	5.95 ea.											
<p><b>BA-012S</b> Magnetic symbols Square small magnetic squares for whiteboards &amp; planning boards 112 symbols per sheet in different colours Weight: 47 g</p>	<p>Price in CHF</p> <table> <tr><td>1 pc.</td><td>5.95 ea.</td></tr> </table>	1 pc.	5.95 ea.	<p>Coloured magnetic squares are eye-catchers and can be used for marking content on whiteboards and other magnetic surfaces.</p>								
1 pc.	5.95 ea.											
<p><b>BA-012T</b> Magnetic symbols Triangle small magnetic triangles for whiteboards &amp; planning boards 180 symbols per sheet in different colours Weight: 47 g</p>	<p>Price in CHF</p> <table> <tr><td>1 pc.</td><td>5.95 ea.</td></tr> </table>	1 pc.	5.95 ea.	<p>Coloured small magnetic triangles are eye-catchers and can be used for marking content on whiteboards and other magnetic surfaces.</p>								
1 pc.	5.95 ea.											
<p><b>BA-012C</b> Magnetic symbols Circle small magnetic circles for whiteboards &amp; planning boards 50 symbols per sheet in different colours Weight: 47 g</p>	<p>Price in CHF</p> <table> <tr><td>1 pc.</td><td>5.95 ea.</td></tr> </table>	1 pc.	5.95 ea.	<p>Coloured small magnetic circle symbols are eye-catchers and can be used for marking content on whiteboards and other magnetic surfaces.</p>								
1 pc.	5.95 ea.											

<b>BA-007</b> Chalk white for writing on wall boards set of 12 Weight: 11 g/set	Price in CHF 1 set 4.95/set	White chalkboard chalk by Pelican, 12-pack. The chalk is dust-free and has a strong colour flow.
<b>BA-008</b> Chalk set multicoloured for writing on wall boards set of 12 Weight: 13 g/set	Price in CHF 1 set 9.95/set	Blackboard chalk set by Pelican, dust-free, in 12 beautiful colours. The intense chalk colours make drawings and writings on the wall chalkboard stand out.
<b>BA-009</b> Holder for whiteboard markers magnetic holder for 4 markers markers not included in delivery Weight: 100 g	Price in CHF 1 pc. 10.60 ea.	Discreet magnetic holder for storing 4 whiteboard or flip chart markers directly on the whiteboard. Delivery without markers.
<b>BA-019</b> Whiteboard marker black whiteboard pen with magnetically adhering eraser Weight: 39 g	Price in CHF 1 pc. 4.95 ea.	Black whiteboard marker S by MAUL with magnetic board wiper (50 mm diameter) that also holds markers. Works on whiteboards, glass, and other smooth and writeable surfaces.
<b>BA-010A</b> Whiteboard wiper magnetic dry eraser with high absorbing power exchangeable fleece Weight: 88 g	Price in CHF 1 pc. 7.40 ea.	Whiteboard eraser, adheres to ferromagnetic surfaces thanks to the internal magnet. The fleece lasts long and has a high absorbency.
<b>BA-018</b> Whiteboard marker pens for whiteboards set of 4 assorted colours Weight: 71 g/set	Price in CHF 1 set 10.90/set	Whiteboard marker in a set of 4. Suitable for whiteboards, glass, and other smooth and writeable surfaces. You will receive the following colours: black, blue, red, green
<b>BA-010B</b> Refill fleece for whiteboard wiper set of 10 Weight: 20 g/set	Price in CHF 1 set 4.75/set	Thick and special fleece for magnetic dry eraser BA-010A. The fleece features economic use and high absorbing capacity. Made in Germany.

## Magnetic hooks & magnetic clips

Coloured and original magnetic hooks and magnetic clips are perfect for use in the office, kitchen or bathroom. They can hold light objects, such as hand towels, kitchen utensils, scissors, key rings, etc. securely on the fridge or on the magnetic board. Thanks to their attractive packaging, they also make for a practical and affordable gift.

<p><b>LIV-162</b> Magnetic hooks 'Wood', holds approx. 1.2 kg with slip-resistant coating set of 2 Weight: 11 g/set strength: approx. 1.2 kg</p>	<p>Price in CHF 1 set 9.90/set</p>	<p>Two decorative magnetic hooks made of beechwood and walnut wood. Perfect for hanging towels and cooking utensils. Available in the versions 'Timber Wood' and 'Wood Hook'.</p>
<p><b>M-90</b> Magnetic hook with rotating double hook, holds approx. 18 kg plasticised extra strong adhesive force approx. 18 kg Weight: 200 g strength: approx. 18 kg</p>	<p>Price in CHF 1 pc. 9.95 ea.</p>	<p>Not your typical magnetic hook: Features not just one but two hooks in different lengths, which can be turned as needed.</p>
<p><b>M-96</b> Magnetic hook with revolving hook, holds approx. 10 kg plasticised extra strong Adhesive force approx. 10 kg Weight: 86 g strength: approx. 10 kg</p>	<p>Price in CHF 1 pc. 13.95 ea.</p>	<p>Sturdy magnetic hook made of black plastic with rotating hook. Strong holding power and improved hold thanks to rubberised backside.</p>
<p><b>LIV-101</b> Magnetic hooks 'Black Mamba' black with slip-resistant coating set of 2 Weight: 200 g/set</p>	<p>Price in CHF 1 set 16.90/set</p>	<p>2 simple black magnetic hooks for use on many ferromagnetic surfaces. With no-slip surface made of silicone.</p>
<p><b>LIV-102</b> Magnetic hooks 'Porta' stainless steel, holds approx. 1 kg with slip-resistant coating set of 2 Weight: 78 g/set strength: approx. 1 kg</p>	<p>Price in CHF 1 set 10.90/set</p>	<p>2 stainless steel magnetic hooks to be used on many magnetic surfaces. Thanks to the slip-resistant silicone surface the hooks can hold a lot without sliding down.</p>
<p><b>LIV-166</b> Magnetic hooks 'Porta' silver-blue, holds approx. 750 g with slip-resistant coating set of 2 Weight: 85 g/set strength: approx. 750 g</p>	<p>Price in CHF 1 set 10.90/set</p>	<p>2 magnetic hooks made of stainless steel for use on many magnetic surfaces. In beautiful silver-blue. Thanks to a non-slip surface made of silicone, these hooks can withstand heavy loads without sliding off.</p>
<p><b>M-86</b> Letter clamp magnetic, holds approx. 4.5 kg magnetic clips made of metal set of 3 silver-coloured Weight: 200 g/set strength: approx. 4.5 kg</p>	<p>Price in CHF 1 set 21.30/set</p>	<p>Practical magnetic file clamps with many positive features: Clever, easy to grasp, sturdy, powerful, universal use. Ideal for storing or presenting letters, documents, files, instructions, and notes.</p>
<p><b>LIV-99</b> Magnetic clips 'Kolor Klip', holds approx. 400 g colourful clothes-peg magnets set of 6 Weight: 27 g/set strength: approx. 400 g</p>	<p>Price in CHF 1 set 10.95/set</p>	<p>Colourful mini wooden pegs with strong neodymium magnet on the backside.</p>

<p><b>LIV-100</b> Magnetic clips 'Graffa' black made of metal set of 4 Weight: 60 g/set</p>	<p>Price in CHF 1 set 10.90/set</p>	<p>Small, discreet black metal clips with a strong magnet on the back.</p>
<p><b>LIV-161</b> Magnetic clips 'Graffa' silver-blue made of metal set of 4 Weight: 60 g/set</p>	<p>Price in CHF 1 set 10.90/set</p>	<p>Small silver-blue metal clips with a strong magnet on the back.</p>
<p><b>LIV-173</b> Magnetic clips 'Graffa' rainbow-coloured magnetic paper clamps made of metal set of 4 Weight: 60 g/set</p>	<p>Price in CHF 1 set 10.90/set</p>	<p>Small metal clips made of iridescent metal that shimmers in rainbow colours – with a strong magnet on the back.</p>
<p><b>LIV-113</b> Magnetic clips 'Graffa' transparent made of plastic set of 4 Weight: 42 g/set</p>	<p>Price in CHF 1 set 10.90/set</p>	<p>Small, discreet clip made of transparent plastic with a strong magnet on the backside.</p>
<p><b>LIV-79</b> Magnetic clips 'Graffa' XL magnetic paper clamps with very high adhesive force set of 2 Weight: 70 g/set</p>	<p>Price in CHF 1 set 13.90/set</p>	<p>Two strong magnetic clips that adhere to any metal surface. You can attach calendars, recipes or magazines to always have them handy. Thanks to the non-slip coating, these clips stay in place even with heavy objects on them.</p>
<p><b>LIV-17</b> Magnetic clips 'Clipper', holds approx. 300 g set of 4 chrome-plated Weight: 33 g/set strength: approx. 300 g</p>	<p>Price in CHF 1 set 12.90/set</p>	<p>The chrome-plated eye catcher for the office - or the laundry room ;-). It holds several notes, single pictures or even a small brochure on a magnetic board. Chrome-plated surface, set of 4. Each clip is 2,5 cm x 1 cm.</p>
<p><b>LIV-61</b> Magnetic hooks 'Solid', holds approx. 2.6 kg classy magnetic hooks set of 4 Weight: 79 g/set strength: approx. 2.6 kg</p>	<p>Price in CHF 1 set 16.90/set</p>	<p>Classy, discreet magnetic hooks can be used on any magnetic surface: Whiteboard, magnetic board, steel cabinet, etc. Thanks to the slip-resistant silicone surface, the hooks can hold even heavy objects without slipping off.</p>
<p><b>LIV-122</b> Colourful magnet clips with ferrite magnets set of 6 Weight: 280 g/set</p>	<p>Price in CHF 1 set 9.95/set</p>	<p>Colourful magnet clips for home, office, storage, school, or workshop. Set of 6 contains magnet clips in different colours.</p>



## Home design & (magnetic) home accessories

Here you can find decorative articles that will beautify your home or office: Colourful magnetic note pads, pencils, bottle opener, hand towel holder, etc. Some articles are not magnetic, which we reference in the product description.

<p><b>LIV-147</b> Trivet Van magnetic made of silicone heat-resistant up to 250 °C Weight: 130 g</p>	<p>Price in CHF 1 pc. 15.90 ea.</p>	<p>Magnetic silicone trivet in the shape of an old VW bus. The gadget for all VW bus enthusiasts!</p>
<p><b>LIV-148</b> Trivet Scooter magnetic made of silicone heat-resistant up to 250 °C Weight: 100 g</p>	<p>Price in CHF 1 pc. 15.90 ea.</p>	<p>The trivet in the shape of a red scooter measures 18 x 12.5 x 0.7 and withstands temperatures of up to 250 °C.</p>
<p><b>LIV-149</b> Trivet Cow magnetic made of silicone heat-resistant up to 250 °C Weight: 84 g</p>	<p>Price in CHF 1 pc. 15.90 ea.</p>	<p>The trivet in the shape of a black and white cow measures 18.7 x 16.5 x 0.5 and withstands temperatures of up to 250 °C.</p>
<p><b>M-SOAP-1</b> Soap holder magnetic, holds approx. 150 g with a suction cup and stainless steel disc to attach in the sink Weight: 17 g strength: approx. 150 g</p>	<p>Price in CHF 1 pc. 9.80 ea.</p>	<p>Magnetic soap holder for securing solid soap (up to 120 g) to the sink. The soap dries easily after use thanks to its attachment with suction cup and metal plate.</p>
<p><b>NGP-05</b> silwy Metal-Nano-Gel-Pads Ø 5.0 cm self-adhering surface for magnets reusable, with synthetic leather coating set of 4, in different colours Weight: 54 g/set</p>	<p>Price in CHF 1 set 12.95/set</p>	<p>The metal-nano-gel-pads by silwy adhere to almost any surface, can be removed without leaving any residue and are reusable any number of times.</p>
<p><b>NGP-06</b> silwy Metal-Nano-Gel-Pads Ø 6.5 cm self-adhering surface for magnets reusable, with synthetic leather coating set of 4, in different colours Weight: 80 g/set</p>	<p>Price in CHF 1 set 16.95/set</p>	<p>The perfect accessory for caravans, campers, campervans, boats, yachts, sailing boats or your home.</p>
<p><b>NGP-CR</b> silwy Metal-Nano-Gel-Pad Ø 6.5 cm with hook magnet 'Clever' self-adhering surface for magnets reusable, with synthetic leather coating set, in different colours Weight: 67 g/set</p>	<p>Price in CHF 1 set 12.95/set</p>	<p>Mounting a hook without drilling? The German brand silwy makes it possible with their metal-nano-gel-pad and a white hook magnet. One set contains one pad and one hook magnet.</p>
<p><b>NGP-FX</b> silwy Metal-Nano-Gel-Pads Ø 5.0 cm with magnetic pins 'Flex' self-adhering surface for magnets reusable, with synthetic leather coating set of 4, in different colours Weight: 94 g/set</p>	<p>Price in CHF 1 set 24.95/set</p>	<p>A strong team: metal-nano-gel-pads by silwy &amp; black magnetic pins. One pin on one pad can hold approx. 10 sheets of paper with a total weight of 80 g.</p>

<p><b>NGP-OE</b> silwy Metal-Nano-Gel-Pad Ø 6.5 cm with rotating hook magnet 'The One' self-adhering surface for magnets reusable, with synthetic leather coating set, in different colours Weight: 130 g/set</p>	<p>Price in CHF 1 set 16.95/set</p>	<p>With the help of this set you can quickly create a space to hang lightweight objects of up to 0.5 kg. Set contains a gel pad and rotating hook magnet.</p>
<p><b>NGP-OV</b> silwy Metal-Nano-Gel-Coasters self-adhering surface for magnets reusable, with synthetic leather coating set of 2, in different colours Weight: 69 g/set</p>	<p>Price in CHF 1 set 14.95/set</p>	<p>These metal-nano-gel-coasters are not only perfect for the magnetic glasses by silwy (available from our shop in spring 2021), but they are also a great surface for attaching our magnets.</p>
<p><b>NGP-SQ</b> silwy Metal-Nano-Gel-Pads square 8.4 x 8.4 cm self-adhering surface for magnets reusable, with synthetic leather coating set of 2, in different colours Weight: 69 g/set</p>	<p>Price in CHF 1 set 14.95/set</p>	<p>The metal-nano-gel-pads by silwy adhere to almost any surface, can be removed without leaving any residue and are reusable any number of times.</p>
<p><b>NGP-ST</b> silwy Metal-Nano-Gel-Pads Ø 5.0 cm with magnets 'Smart' self-adhering surface for magnets reusable, with synthetic leather coating set of 2, in different colours Weight: 130 g/set</p>	<p>Price in CHF 1 set 19.95/set</p>	<p>Thanks to the metal-nano-gel-pads by silwy, you can create an area for attaching magnets on almost any surface. One set contains 2 pads and 2 stylish magnets. One magnet on the pad holds approx. 20 sheets of paper with a total weight of 80 g.</p>
<p><b>TUT-01</b> Tütenhüter set of 6 bag sealing system set of 6 with 3 sizes in different colours Weight: 100 g/set</p>	<p>Price in CHF 1 set 16.95/set</p>	<p>The Tütenhüter chip clips in different colours and sizes seal packaging made of aluminium, paper and plastic so that it is airtight and watertight. Available in a set of 6 with 3 sizes.</p>
<p><b>TUT-02</b> Tütenhüter S light green bag sealing system single piece, without packaging 14 cm Weight: 10 g</p>	<p>Price in CHF 1 pc. 3.20 ea.</p>	<p>The Tütenhüter S in light green seals packaging made of aluminium, plastic and paper so that it is airtight and watertight. Item sold individually (without packaging wrapper).</p>
<p><b>TUT-03</b> Tütenhüter XL purple bag sealing system single piece, without packaging 29 cm Weight: 30 g</p>	<p>Price in CHF 1 pc. 3.60 ea.</p>	<p>The Tütenhüter in purple (XL) seals packaging made of aluminium, plastic and paper so that it is airtight and watertight. Item sold individually (without packaging wrapper).</p>
<p><b>M-BOOK</b> Bookends magnetic metal set of 2 in different colours Weight: 510 g/set</p>	<p>Price in CHF 1 set 11.30/set</p>	<p>Thanks to the strong magnetic area on the bottom side, they securely stay in place on steel shelves and provide the wanted stability. Available in three colours.</p>
<p><b>SALE-115</b> Metal hooks self-adhesive round, blue set of 4 not magnets! Weight: 52 g/set</p>	<p>Price in CHF 1 set 3.90/set</p>	<p>Elegant round metal hooks with strong 3M adhesive on the backside adhere securely to smooth surfaces. You receive four round blue hooks.</p>

<p><b>M-73</b> Tea infuser Iceberg silicone tea infuser non-magnetic! Weight: 54 g</p>	<p>Price in CHF 1 pc. 7.95 ea.</p>	<p>Funny tea infuser in the shape of a polar bear family on an iceberg. Material: Silicone</p>
<p><b>M-39</b> Beer tree small magnetic beer cap collector ideal party gift holds up to 70 bottle caps Weight: 97 g</p>	<p>Price in CHF 1 pc. 24.95 ea.</p>	<p>For the beer tree you don't need a green thumb, you just need to be thirsty, because with every bottled beer your tree will grow a little bit. The strong magnet on the top of the tree trunk can easily hold 50 bottle caps, if you work on it even up to 70. The more you add, the more impressive the treetop will be.</p>
<p><b>M-47</b> Beer tree large magnetic beer cap collector ideal party gift holds up to 120 bottle caps Weight: 150 g</p>	<p>Price in CHF 1 pc. 39.90 ea.</p>	<p>For the beer tree you don't need a green thumb, you just need to be thirsty, because with every bottled beer your tree will grow a little bit. The strong magnet on the top of the tree trunk can easily hold 120 bottle caps.</p>
<p><b>M-91</b> Magnetic bottle opener "Captor" cap lifter, attaches to a fridge or the like with bottle cap collector on the front Weight: 470 g</p>	<p>Price in CHF 1 pc. 29.00 ea.</p>	<p>Cast iron bottle opener for the wall collects up to 50 bottle caps thanks to the strong neodymium magnet on the front. Can be mounted to nearly all metal surfaces with the four rubberised neodymium magnets on the backside.</p>
<p><b>M-40</b> Wall bottle opener beer bottle opener with magnetic bottle cap collector incl. mounting accessories Weight: 470 g/set</p>	<p>Price in CHF 1 set 33.00/set</p>	<p>This magnetic bottle opener not only attracts everyone's attention - it also catches the falling bottle caps. It can collect up to 60 caps that form a cluster underneath the opener.</p>
<p><b>LIV-106</b> Magnetic bottle opener cap lifter, attaches to a fridge or the like set of 2 Weight: 71 g/set</p>	<p>Price in CHF 1 set 4.95/set</p>	<p>Colourful, handy bottle opener with beer designs and magnet on the backside.</p>
<p><b>M-43</b> Wooden magnet set 27 magnetic wooden cubes made of oiled oak wood Weight: 510 g/set</p>	<p>Price in CHF 1 set 64.95/set</p>	<p>Thanks to the embedded sphere magnets, the 27 wooden cubes are magnetic on all six sides, which allows for building various imaginative constructs.</p>
<p><b>M-41</b> Tangram cube made of 24 magnetic tetrahedrons with 20 templates Weight: 590 g</p>	<p>Price in CHF 1 pc. 29.95 ea.</p>	<p>You need all your wits for this game! The Tangram cube consists of 24 magnetic plastic pyramids. With these tetrahedrons you can also build more challenging shapes and figures.</p>
<p><b>LIV-33</b> Magnetic vase Maple vase made of maple wood magnetic on metal plate gift-wrapped Weight: 78 g</p>	<p>Price in CHF 1 pc. 19.95 ea.</p>	<p>This delicate maple vase stands out with its simple elegance and clever functionality.</p>

<b>LIV-34</b> Magnetic vase Oak vase made of oak wood magnetic on metal plate gift-wrapped Weight: 88 g	Price in CHF 1 pc. 19.95 ea.	This delicate oak vase stands out with its simple elegance and clever functionality.
<b>MON-01</b> Monolux magnetic candle holder in a gift box Weight: 120 g	Price in CHF 1 pc. 24.95 ea.	The Monolux always finds a place - wherever you wish for cosiness. It stays wherever there is a magnetic surface! On the fridge, on a shelf, on the stair railing and even on a pin...
<b>M-77</b> Hot food bag with cherry pit pad with magnetic catch in various designs Weight: 300 g	Price in CHF 1 pc. 29.95 ea.	These pretty hot food bags are made in a sheltered workshop in Switzerland and display classic Swiss motifs, such as the alpine cattle-drive and the famous edelweiss. With the practical magnetic catch you can conveniently close the bag.

## Metal strips: decorative surfaces for magnets

<p><b>M-FERROTAPE</b> Metal tape self-adhesive white 35 mm self-adhesive surface for magnets rolls of 1 m / 5 m / 25 m Weight: 75 g/m</p>	<p>Price in CHF</p> <p>1 m 5.59/m</p> <p>from 5 m 3.86/m</p> <p>from 25 m 2.81/m</p>	<p>Metal tape with self-adhesive cushioning on the back. The strip can be cut with normal scissors to the desired length, since it is only 0.15 mm thick. It also adheres to textured walls and is easy to install around corners.</p>
<p><b>NGP-MB-25</b> silvy metal strip self-adhesive 25 cm self-adhesive surface for magnets with synthetic leather cover in different colours Weight: 240 g</p>	<p>Price in CHF</p> <p>1 pc. 29.95 ea.</p> <p>from 3 pcs. 27.95 ea.</p> <p>from 5 pcs. 25.95 ea.</p>	<p>The metal strip with 3M adhesive film is ideal as a decorative adhesive surface for magnets. A perfect accessory for caravans, campers, boats, yachts, sailing boats or your home.</p>
<p><b>NGP-MB-50</b> silvy metal strip self-adhesive 50 cm self-adhesive surface for magnets with synthetic leather cover in different colours Weight: 540 g</p>	<p>Price in CHF</p> <p>1 pc. 44.95 ea.</p> <p>from 3 pcs. 42.95 ea.</p> <p>from 5 pcs. 41.95 ea.</p>	<p>Length: 50 cm Width: 5 cm Thickness: 3 mm Material: premium synthetic leather Made in: Germany</p>
<p><b>MB-18</b> Metal strip self-adhesive 50 cm self-adhesive surface for magnets metal in different colours Weight: 160 g</p>	<p>Price in CHF</p> <p>1 pc. 4.15 ea.</p> <p>from 3 pcs. 3.80 ea.</p> <p>from 10 pcs. 3.45 ea.</p> <p>from 40 pcs. 3.15 ea.</p> <p>from 80 pcs. 3.00 ea.</p>	<p>This narrow metal strip is an ideal surface for small magnets. It is great for attaching postcards, event flyers, photos, business cards, children's drawings, posters, etc. with magnets.</p>
<p><b>MB-19</b> Metal strip self-adhesive 80 cm self-adhesive surface for magnets metal in different colours Weight: 260 g</p>	<p>Price in CHF</p> <p>1 pc. 6.20 ea.</p> <p>from 3 pcs. 5.70 ea.</p> <p>from 10 pcs. 5.25 ea.</p> <p>from 40 pcs. 4.80 ea.</p> <p>from 80 pcs. 4.60 ea.</p>	<p>This narrow self-adhesive metal strip (80 cm) is the perfect surface for small magnets. Use it to hang notes, photos, drawings, posters, etc.</p>
<p><b>MB-17</b> Metal strip "Element Big" 70 cm surface for magnets, to screw on incl. 12 strong magnets in different colours Weight: 310 g</p>	<p>Price in CHF</p> <p>1 pc. 21.90 ea.</p> <p>from 3 pcs. 19.70 ea.</p> <p>from 10 pcs. 18.20 ea.</p> <p>from 40 pcs. 17.80 ea.</p> <p>from 80 pcs. 16.85 ea.</p>	<p>This 70 cm long magnetic strip made of steel sheet can easily be screwed onto the wall with two screws. The included 12 small magnets can hold photos, shopping lists, etc.</p>
<p><b>MB-16</b> Metal strip "Element Small" 35 cm surface for magnets, to screw on incl. 6 strong magnets in different colours Weight: 130 g</p>	<p>Price in CHF</p> <p>1 pc. 14.90 ea.</p>	<p>This discreet metal strip is made of steel sheet and is easily wall-mounted with two screws. The included 6 small magnets can hold photos, shopping lists, etc.</p>
<p><b>FO-5</b> Metal strips stainless steel 50 cm, set of 2 surface for magnets with magnetic mounting incl. 12 strong magnets Weight: 490 g/set</p>	<p>Price in CHF</p> <p>1 set 20.00/set</p>	<p>Two metal strips made of 1.5 mm thick stainless steel, polished on one side and brushed on the other. Includes 12 disc magnets.</p>

<p><b>MB-01</b> Metal strip "Mikado" black 80 cm surface for magnets with magnetic mounting incl. 10 strong magnets Weight: 270 g</p>	<p>Price in CHF 1 pc. 29.90 ea.</p>	<p>Steel sheet ledge including 10 magnets. This simple steel sheet ledge is attached to the wall with two bigger magnets. You can attach photos, shopping list, etc. with the enclosed 10 small magnets.</p>
<p><b>MB-02</b> Metal strip "Mikado" grey 80 cm surface for magnets with magnetic mounting incl. 10 strong magnets Weight: 270 g</p>	<p>Price in CHF 1 pc. 29.90 ea.</p>	<p>Steel sheet ledge including 10 magnets. This simple steel sheet ledge is attached to the wall with two bigger magnets. You can attach photos, shopping list, etc. with the enclosed 10 small magnets.</p>
<p><b>MB-04</b> Metal strip "Mikado" white 80 cm surface for magnets with magnetic mounting incl. 10 strong magnets Weight: 270 g</p>	<p>Price in CHF 1 pc. 29.90 ea.</p>	<p>Steel sheet ledge including 10 magnets. This simple steel sheet ledge is attached to the wall with two bigger magnets. You can attach photos, shopping list, etc. with the enclosed 10 small magnets.</p>

## Ferrous strips & metal strips

<p><b>FT-1005</b> Ferrous tape self-adhesive 5 m x 10 mm self-adhesive surface for magnets rolls of 5 m each in different colours Weight: 180 g</p>	<p>Price in CHF 1 pc. 4.20 ea. from 3 pcs. 3.60 ea. from 10 pcs. 3.05 ea. from 20 pcs. 2.80 ea. from 40 pcs. 2.55 ea.</p>	<p>Ferrous tape is a thin plastic strip containing iron particles. Large pot magnets and neodymium magnets are not suitable for use on ferrous strips, due to their considerable weight.</p>
<p><b>FT-1025</b> Ferrous tape self-adhesive 25 m x 10 mm self-adhesive surface for magnets rolls of 25 m each in different colours Weight: 910 g</p>	<p>Price in CHF 1 pc. 16.50 ea. from 3 pcs. 14.20 ea. from 10 pcs. 12.15 ea. from 20 pcs. 11.10 ea.</p>	<p>This self-adhesive ferrous strip is an ideal surface for magnets. You can easily cut the ferrous tape to size using household scissors or a cutter.</p>
<p><b>FT-2005</b> Ferrous tape self-adhesive 5 m x 20 mm self-adhesive surface for magnets rolls of 5 m each in different colours Weight: 370 g</p>	<p>Price in CHF 1 pc. 7.60 ea. from 3 pcs. 6.50 ea. from 10 pcs. 5.50 ea. from 20 pcs. 5.00 ea. from 40 pcs. 4.60 ea.</p>	<p>Create order in your everyday life with self-adhesive ferrous tape. The flexible strip lets you create a suitable surface for magnets in no time.</p>
<p><b>FT-2025</b> Ferrous tape self-adhesive 25 m x 20 mm self-adhesive surface for magnets rolls of 25 m each in different colours Weight: 1.8 kg</p>	<p>Price in CHF 1 pc. 29.50 ea. from 3 pcs. 25.40 ea. from 10 pcs. 21.70 ea.</p>	<p>Mounting a ferrous strip is very simple: Remove the protective film from the self-adhesive backing and press the ferrous tape firmly onto the desired surface. No need for drilling any holes.</p>
<p><b>LIV-167</b> Magnetic dots 'Element Flex Dot' self-adhesive self-adhesive surfaces for magnets 28 dots in various colours, not a magnet! Weight: 63 g</p>	<p>Price in CHF 1 pc. 6.90 ea.</p>	<p>With the self-adhesive magnetic dots 'Element Flex Dot' you can create a small, almost invisible surface for magnets in a few simple steps. The magnetic dots are available in black, white and multi-colour.</p>
<p><b>ML-SB1</b> Metal tape 'Story Box' with magnets self-adhesive incl. 4 decorative magnets in different designs Weight: 100 g</p>	<p>Price in CHF 1 pc. 16.90 ea.</p>	<p>With the 'Story Box' metal tape, you can create a surface for magnets on any smooth wall. Four decorative magnets in the shape of ducks, planets or goats securely hold your notes, postcards or pictures.</p>

## Magnetic closures for jewellery, bags, shoes and furniture

Jewellery, shoes or hand-sewn purses - a magnetic clasp is the right solution for easy closing and opening. The two parts find each other all by themselves. Once closed, the strong magnets ensure a secure hold. To open them you simply shift them sideways or in opposite directions.

<p><b>CLA-14</b> Magnetic closure bag small, holds approx. 1.5 kg magnetic buttons 4-piece set for leather, fabric and other textiles Weight: 3.5 g strength: approx. 1.5 kg</p>	<p>Price in CHF 10 pcs. 0.62 ea. from 40 pcs. 0.52 ea. from 80 pcs. 0.47 ea. from 160 pcs. 0.43 ea.</p>	<p>The perfect closure for your handmade bags! Suitable for fastening leather or thick material. You will receive 4 pieces: 1 clamp (Magnet) with recess, 1 clamp (counterpiece) with knob, 2 reinforcement discs.</p>
<p><b>CLA-18</b> Magnetic closure bag large, holds approx. 2.5 kg magnetic buttons 4-piece for leather, fabric and other textiles Weight: 5.5 g strength: approx. 2.5 kg</p>	<p>Price in CHF 5 pcs. 0.80 ea. from 15 pcs. 0.70 ea. from 40 pcs. 0.62 ea. from 80 pcs. 0.57 ea.</p>	<p>The perfect closure for your handmade bags! Suitable for fastening leather or thick material. You will receive 4 pieces: 1 clamp (Magnet) with recess, 1 clamp (counterpiece) with knob, 2 reinforcement discs</p>
<p><b>SV-ES-08</b> Jewellery clasp magnetic round small magnetic closure for necklaces / bracelets Ø 8 mm Weight: 1 g</p>	<p>Price in CHF 1 pc. 5.90 ea. from 3 pcs. 5.40 ea. from 10 pcs. 4.95 ea. from 20 pcs. 4.75 ea. from 40 pcs. 4.55 ea.</p>	<p>This discreet, spherical magnetic jewellery clasp is perfect for thin necklaces and bracelets of all sorts. Two strong magnets are glued into the plastic clasp and safely hold your jewellery together.</p>
<p><b>SV-ES-15</b> Jewellery clasp magnetic round large magnetic closure for necklaces / bracelets Ø 15 mm Weight: 3.5 g</p>	<p>Price in CHF 1 pc. 8.90 ea. from 3 pcs. 8.15 ea. from 10 pcs. 7.45 ea. from 20 pcs. 7.10 ea. from 40 pcs. 6.80 ea.</p>	<p>This ball-shaped magnetic jewellery clasp is perfect for necklaces and bracelets. Two extremely strong magnets are glued into the plastic claps and guarantee that the jewellery stays together safely.</p>
<p><b>SV-FP-01</b> Jewellery clasp magnetic with pattern magnetic closure for bracelets extra-strong hold Weight: 8 g</p>	<p>Price in CHF 1 pc. 8.90 ea. from 3 pcs. 8.10 ea. from 10 pcs. 7.40 ea. from 20 pcs. 7.05 ea. from 40 pcs. 6.70 ea.</p>	<p>Strong jewellery clasp with neodymium magnets for flat bracelets (opening 10 x 2 mm). Nickel-free, lead-free and cadmium-free.</p>
<p><b>SV-K01</b> Jewellery clasp magnetic Celtic magnetic closure for bracelets rectangular Weight: 8 g</p>	<p>Price in CHF 1 pc. 8.90 ea. from 3 pcs. 8.10 ea. from 10 pcs. 7.40 ea. from 20 pcs. 7.05 ea. from 40 pcs. 6.70 ea.</p>	<p>Extra strong jewellery clasp with neodymium magnets for flat bracelets (opening 10 x 2 mm). Nickel-free, lead-free and cadmium-free.</p>
<p><b>M-ZUB-01</b> Zubits® S magnetic shoe closures for children &amp; the elderly in different colours Weight: 31 g/set</p>	<p>Price in CHF 1 set 20.95/set</p>	<p>Magnetic shoe closure for quick in and out of shoes. Secure footing, even with heavy use.</p>
<p><b>M-ZUB-02</b> Zubits® M magnetic shoe closures for youth &amp; adults in different colours Weight: 40 g/set</p>	<p>Price in CHF 1 set 21.45/set</p>	<p>Magnetic shoe closures for quick in and out of shoes. Secure hold, even when active.</p>



**M-ZUB-03**

Zubits® L  
magnetic shoe closures  
for sports shoes & tall  
people  
in different colours  
Weight: 45 g/set

Price in CHF    Magnetic shoe closure for quick in and out of shoes.  
1 set    21.95/set    Secure footing, even with heavy use.

## Sugru: Clever adhesive putty

Are you looking for an all-purpose helper for attachments and repairs? Then you need the wonder putty Sugru with 1001 application possibilities the right thing for you! It is a mouldable adhesive made of silicone rubber, which is very flexible and mouldable into various shapes. It adheres to many different materials and combines them permanently. It is also suitable for repairing holes, rips, cable breaks, and other damages. Since the adhesive putty is available in so many different colours, you can choose if you would like your repair in a low-key black, white, or grey or if you prefer bright colours that draw attention to the successful life hack.

<b>SUG-KIT</b> Sugru Kit set with adhesive putty 2 different versions in a practical metal tin Weight: 130 g	Price in CHF 1 pc. 18.45 ea.	Table of Contents: 4 pieces Colour: Black, white, grey, red
<b>SUG-08</b> Sugru Set of 8 adhesive putty in different colours packages of 5 g each Weight: 69 g/set	Price in CHF 1 set 18.90/set	Sugru is an adhesive putty that is very easy to use. Simply mould it by hand and put it in place, let it harden over night at room temperature, done! Set with 8 single-use packets.
<b>SUG-03</b> Sugru set of 3 adhesive putty in different colours packages of 5 g each Weight: 30 g/set	Price in CHF 1 set 7.90/set	Sugru is an adhesive putty that is very easy to use. Simply mould it by hand and put it in place, let it harden over night at room temperature, done! Set with 3 single-use packets.

## Smart putty: Fun & play with magnetic putty & Co.

Smart Putty impresses with cool tricks and fascinating effects. You can shape it, knead it, pull it, rip it, or let it bounce. We carry many different types of this putty, each with unique features. The ferromagnetic putty is attracted by magnets, "Glow" glows in the dark, "Metallic" surprises with a metallic look.

<b>M-PUTTY-FERRO</b> Smart putty magnetic ferromagnetic putty different colours magnet not included Weight: 140 g	Price in CHF 1 pc. 13.45 ea.	The magnetic smart putty impresses with cool tricks and fascinating effects. As soon as a super magnet is nearby, the smart putty seems to come to life. Available in many colours.
<b>M-PUTTY-GLOW</b> Smart putty Glow glows in the dark different colours not magnetic! Weight: 140 g	Price in CHF 1 pc. 12.95 ea.	Smart putty impresses with cool tricks and fascinating effects. The model "Glow" even glows in the dark.
<b>M-PUTTY-CAMO</b> Smart putty Camo changes colour during kneading different colours not magnetic! Weight: 140 g	Price in CHF 1 pc. 13.45 ea.	Smart putty impresses with cool tricks and fascinating effects. The model "Camo" even changes colour.
<b>M-PUTTY-IRIS</b> Smart putty Flip Flop shimmers in various colours not magnetic! Weight: 140 g	Price in CHF 1 pc. 13.95 ea.	Smart putty impresses with cool tricks and fascinating effects. The model "Flip Flop" also shimmers in the most beautiful colours.
<b>M-PUTTY-GLASS</b> Smart putty "Crystal Clear" transparent not magnetic! Weight: 140 g	Price in CHF 1 pc. 12.95 ea.	What? An empty can? No, this smart putty is transparent and looks like liquefied glass!
<b>M-PUTTY-GLITTER</b> Smart putty sparkling with glitter different colours not magnetic! Weight: 140 g	Price in CHF 1 pc. 13.45 ea.	Smart putty impresses with cool tricks and fascinating effects. Additional feature of the 'Glitter' type: It shimmers as if millions of stars were trapped inside!
<b>M-PUTTY-METALLIC</b> Smart putty Metallic metallic sparkling different colours not magnetic! Weight: 140 g	Price in CHF 1 pc. 13.45 ea.	Smart putty impresses with cool tricks and fascinating effects. Additional feature of the "Metallic" type: It looks like molten metal that melts in your hand!

## Magnetic toys for children

Our colourful magnetic toys with their different shapes offer long-lasting fun at playtime. With a little imagination the magnetic elements can be put together again and again to form new objects and configurations. That's not only fun for kids but also for grown-ups. We, here at supermagnete, are perfect proof of that!<br/> Our tip: Magnetic toys are a great gift for children to introduce them to magnetism through play.

<b>TG-CUBE-01</b> Speed cube 3x3 WeiLong GTS2M by MoYu magnetic Weight: 88 g	Price in CHF 1 pc. 29.95 ea.	The WeiLong GTS2M by MoYu features integrated magnets which have an extremely positive effect on the solving accuracy.
<b>TG-CUBE-02</b> Speed cube 4x4 WuQue Mini M by QiYi magnetic Weight: 140 g	Price in CHF 1 pc. 34.95 ea.	The WuQue Mini M by QiYi is a 4x4 speed cube. Magnets on the inside of this cube provide better accuracy when solving the puzzle.
<b>TG-CUBE-03</b> Magic pyramid Pyraminx Bell Pyraminx by QiYi magnetic Weight: 110 g	Price in CHF 1 pc. 12.95 ea.	Bell Pyraminx magic pyramid with magnets inside. You can place these magnets as needed.
<b>TG-CUBE-04</b> Speed cube Skewb Wingy Skewb by QiYi magnetic Weight: 100 g	Price in CHF 1 pc. 14.95 ea.	Wingy Skewb speed cube with slightly concave sides. There are 24 small magnets on the inside, making it easier to position the individual parts.
<b>TG-GEO-04</b> Geomag Panels 32 magnetic construction set 32 pieces Weight: 310 g/set	Price in CHF 1 set 21.10/set	GEOMAG Panels magnetic construction kit with 32 pieces in blue, light green and dark green. 12 magnetic rods, 9 metal balls, 8 triangular panels, 2 square panels, 1 pentagonal panel.

## Furniture magnets

<p><b>M-DOOR-01</b> Door stop magnetic, holds approx. 10 kg to hold doors open Weight: 63 g strength: approx. 10 kg</p>	<p>Price in CHF</p> <p>1 pc. 11.20 ea. from 3 pcs. 10.30 ea. from 10 pcs. 9.45 ea. from 20 pcs. 9.05 ea. from 40 pcs. 8.70 ea.</p>	<p>The magnetic door stopper is great for keeping wooden doors open. It can be embedded in the bottom of the door or screwed into the back of the door.</p>
<p><b>M-DOOR-02</b> Plastic casing for door stop M-DOOR-01 to screw to the side of the door Weight: 10 g</p>	<p>Price in CHF</p> <p>1 pc. 4.25 ea. from 3 pcs. 3.85 ea. from 10 pcs. 3.50 ea. from 20 pcs. 3.30 ea. from 40 pcs. 3.15 ea.</p>	<p>Length: 65 mm Width: 29 mm Height: 36 mm</p>
<p><b>M-DOOR-03</b> Mounting set for door stops metal disc with countersunk hole to screw into the floor or wall Weight: 30 g/set</p>	<p>Price in CHF</p> <p>1 set 2.75/set from 3 sets 2.50/set from 10 sets 2.20/set from 20 sets 2.10/set from 40 sets 2.00/set</p>	<p>Diameter: 45 mm Thickness: 2 mm</p>
<p><b>M-DOOR-04</b> Door stop magnetic, holds approx. 15 kg with round pole areas adhesive angle of 280° Weight: 71 g strength: approx. 15 kg</p>	<p>Price in CHF</p> <p>1 pc. 8.60 ea. from 3 pcs. 7.95 ea. from 10 pcs. 7.35 ea. from 20 pcs. 7.05 ea. from 40 pcs. 6.75 ea.</p>	<p>Length: 60 mm Length 2: 16 mm Width: 25 mm Width 2: 15.5 mm Diameter: 9 mm Diameter 2: 5.5 mm</p>
<p><b>M-DOOR-05</b> Door stop magnetic with rubber buffer, holds approx. 6 kg made of plastic, black Weight: 22 g strength: approx. 6 kg</p>	<p>Price in CHF</p> <p>1 pc. 6.65 ea. from 3 pcs. 6.10 ea. from 10 pcs. 5.55 ea. from 20 pcs. 5.30 ea. from 40 pcs. 5.05 ea.</p>	<p>Length: 65 mm Length 2: 50 mm Width: 30 mm Height: 23 mm Diameter: 22 mm Diameter 2: 5 mm</p>
<p><b>M-FURN-01</b> Magnetic fitting round for furniture, holds approx. 600 g set of magnet &amp; metal plate to screw on Weight: 13 g/set strength: approx. 600 g</p>	<p>Price in CHF</p> <p>1 set 2.75/set from 3 sets 2.45/set from 10 sets 2.20/set from 20 sets 2.05/set from 40 sets 1.95/set</p>	<p>Diameter: 12 mm Height: 2 mm Total height: 12.5 mm</p>
<p><b>M-FURN-02</b> Magnetic fitting oval for furniture, holds approx. 1 kg set of magnets &amp; metal discs to screw on Weight: 10 g/set strength: approx. 1 kg</p>	<p>Price in CHF</p> <p>1 set 2.55/set from 3 sets 2.30/set from 10 sets 2.05/set from 20 sets 1.95/set from 40 sets 1.80/set</p>	<p>Length: 20 mm Width: 10 mm Height: 2 mm Total height: 5.5 mm</p>
<p><b>M-FURN-03</b> Magnetic fitting narrow for furniture, holds approx. 2.5 kg metal with counterpart available in two versions Weight: 30 g strength: approx. 2.5 kg</p>	<p>Price in CHF</p> <p>1 pc. 7.50 ea. from 3 pcs. 6.85 ea. from 10 pcs. 6.30 ea. from 100 pcs. 5.75 ea. from 500 pcs. 5.49 ea.</p>	<p>Narrow metal fitting with counterpart plate that can be used if needed. Fitting made of powder-coated metal, adhering surface rubberised.</p>

**M-FURN-04**

Magnetic fitting wide for  
furniture, holds approx. 2.5 kg  
metal  
with counterpart  
available in two versions  
Weight: 55 g  
strength: approx. 2.5 kg

Price in CHF

	1 pc.	8.20 ea.
from	3 pcs.	7.50 ea.
from	10 pcs.	6.85 ea.
from	100 pcs.	6.30 ea.
from	500 pcs.	5.95 ea.

Wide metal fitting with long holes. Includes counterpart  
plate that can be used if needed. Fitting made of powder-  
coated metal, adhering surface rubberised.

## Practical (magnet) products for the workshop

For tradespeople or DIY types - magnets are a big help in the workshop. You can comfortably pick up metal pieces with a telescope magnet. A bit holder ensures that you have accessories handy and a nail holder or welding aid helps you get done quicker. Our versatile assortment offers you useful products, such as an adhesive for magnets, a suitcase to store magnets, or the wonder putty Sugru.

<p><b>WS-MTH-01</b> Tool rack magnetic 35 cm magnetic bar screw-on tool holder Weight: 480 g</p>	<p>Price in CHF 1 pc. 8.50 ea. from 3 pcs. 7.30 ea. from 10 pcs. 6.25 ea.</p>	<p>This magnetic strip for tools measures 34.5 cm and can be fastened with four screws.</p>
<p><b>WS-MTH-02</b> Tool rack magnetic 51 cm magnetic bar screw-on tool holder Weight: 730 g</p>	<p>Price in CHF 1 pc. 13.65 ea. from 3 pcs. 11.70 ea. from 10 pcs. 9.95 ea.</p>	<p>This magnetic strip for tools measures 51 cm and can be fastened with four screws.</p>
<p><b>WS-MTH-03</b> Tool rack magnetic with handle magnetic bar tool holder with magnetic backside Weight: 590 g</p>	<p>Price in CHF 1 pc. 15.40 ea. from 3 pcs. 13.30 ea. from 10 pcs. 11.40 ea.</p>	<p>This magnetic strip for tools features a magnetic backside, so it can be securely attached to metal cupboards or drawers. Thanks to the handle you can easily remove it and put it wherever you need it.</p>
<p><b>WS-MWH-02</b> Magnetic wristband perfect for craftspeople holds nails, screws, bits, etc. Weight: 150 g</p>	<p>Price in CHF 1 pc. 4.60 ea. from 3 pcs. 3.95 ea. from 10 pcs. 3.40 ea.</p>	<p>Keeping screws and bits handy! With the wrist master you have metal parts close at hand - literally!</p>
<p><b>WS-ADH-01</b> UHU MAX REPAIR magnet glue, waterproof, without solvents shelf life of 24 months 20 g tube Weight: 20 g</p>	<p>Price in CHF 1 pc. 7.95 ea. (397.50/kg)</p>	<p>Do you need a reliable adhesive for your super magnet application? We can recommend this adhesive with conviction. Suitable to use on wood, fabric, leather, cork, metal, glass, plastic, rubber, ceramic, stone or cement.</p>
<p><b>WS-PUT-01</b> Telescoping magnetic pick up tool small, holds approx. 800 g extendable magnetic rod 125-635 mm Weight: 35 g strength: approx. 800 g</p>	<p>Price in CHF 1 pc. 2.35 ea. from 3 pcs. 2.10 ea. from 10 pcs. 1.85 ea.</p>	<p>A small telescoping magnetic pick up tool in practical pen format for retrieving metal parts quickly and safely.</p>
<p><b>WS-PUT-02</b> Telescoping magnetic pick up tool large, holds approx. 2.5 kg extendable magnetic rod 168-855 mm Weight: 90 g strength: approx. 2.5 kg</p>	<p>Price in CHF 1 pc. 4.40 ea. from 3 pcs. 3.90 ea. from 10 pcs. 3.45 ea.</p>	<p>A large and strong telescoping magnetic pick up tool for retrieving metal items quickly and safely. Thanks to the pen clip, you can easily attach the magnetic pick up tool to any jacket pocket.</p>
<p><b>WS-PUT-03</b> Magnetic pick up tool flexible, holds approx. 1 kg magnetic rod with flexible gooseneck 502 mm Weight: 120 g strength: approx. 1 kg</p>	<p>Price in CHF 1 pc. 4.30 ea. from 3 pcs. 3.90 ea. from 10 pcs. 3.50 ea.</p>	<p>Give your back a rest and use this gooseneck magnetic pick up tool to retrieve metal parts off the floor or from hard-to-reach places.</p>

<p><b>WS-PUT-04</b> Magnetic collector magnetic pick up tool with release mechanism 100 mm diameter adhesive force approx. 2.2 kg Weight: 490 g</p>	<p>Price in CHF 1 pc. 9.95 ea.</p>	<p>This magnetic collector with release mechanism is perfect for picking up small metal objects.</p>
<p><b>WS-MNS</b> Nail holder magnetic tool for hammering nails, 145 mm long red Weight: 20 g</p>	<p>Price in CHF 1 pc. 1.95 ea.</p>	<p>An affordable and practical magnetic tool for hammering in nails safely</p>
<p><b>WS-FMG-L</b> Magnetic gloves L perfect for craftspeople will hold nails, screws, bits, etc. pair of gloves in size L Weight: 110 g</p>	<p>Price in CHF 1 pc. 14.95 ea.</p>	<p>The magnetic glove from MagnoGrip allows you to to keep nails, screws, nuts or drill bits on the back of your hand while you work. Size L.</p>
<p><b>WS-FMG-M</b> Magnetic gloves M perfect for craftspeople will hold nails, screws, bits, etc. pair of gloves in size M Weight: 110 g</p>	<p>Price in CHF 1 pc. 14.95 ea.</p>	<p>The magnetic glove from MagnoGrip allows you to to keep nails, screws, nuts or drill bits on the back of your hand while you work. Size M.</p>
<p><b>WS-MTR-01</b> Magnetic bowl small magnetic plate for nails, screws, bits, etc. 108 x 22 mm Weight: 190 g</p>	<p>Price in CHF 1 pc. 2.20 ea. from 3 pcs. 2.00 ea. from 10 pcs. 1.80 ea.</p>	<p>The search for paper clips and screws is finally over! Small metal parts can be stored safely and in style in the small magnetic bowl made of chrome steel.</p>
<p><b>WS-MTR-02</b> Magnetic bowl large magnetic plate for nails, screws, bits, etc. 148 x 25 mm Weight: 350 g</p>	<p>Price in CHF 1 pc. 2.75 ea. from 3 pcs. 2.50 ea. from 10 pcs. 2.35 ea.</p>	<p>The search for paper clips and screws is finally over! Small metal parts can be stored safely and in style in the large magnetic bowl made of chrome steel.</p>
<p><b>WS-MTR-03</b> Magnetic bowl rectangular magnetic plate for nails, screws, bits, etc. 237 x 136 x 28 mm Weight: 500 g</p>	<p>Price in CHF 1 pc. 4.25 ea. from 3 pcs. 3.95 ea. from 10 pcs. 3.65 ea.</p>	<p>The search for paper clips and screws is finally over! Small metal parts can be stored safely and in style in the rectangular magnetic bowl made of chrome steel.</p>
<p><b>WS-MTR-04</b> Magnetic bowl collapsible magnetic plate made of rubber for nails, screws, bits, etc. Weight: 200 g</p>	<p>Price in CHF 1 pc. 3.25 ea. from 3 pcs. 3.05 ea. from 10 pcs. 2.85 ea.</p>	<p>This magnetic bowl made of soft rubber can be folded flat to bring with you or store away - it doesn't take much room. Diameter 135 mm.</p>
<p><b>WS-WLD-01</b> Welding magnet small magnetic welding angle with on/off switch side length approx. 9.5 cm Weight: 640 g</p>	<p>Price in CHF 1 pc. 17.20 ea. from 3 pcs. 15.90 ea. from 10 pcs. 14.75 ea.</p>	<p>The little welding helper works with steel, sheets, pipes, brackets and round material.</p>



<p><b>WS-WLD-02</b> Welding magnet large magnetic welding angle with on/off switch side length approx. 12 cm Weight: 1.3 kg</p>	<p>Price in CHF 1 pc. 25.70 ea. from 3 pcs. 23.85 ea. from 10 pcs. 22.15 ea.</p>	<p>The big welding helper works with steel, sheets, pipes, brackets and round material.</p>
<p><b>WS-WSF-01</b> Clipboard aluminium magnetic with clamp A4 format Weight: 290 g</p>	<p>Price in CHF 1 pc. 18.95 ea.</p>	<p>This magnetic aluminium clipboard can be attached to all ferrous surfaces thanks to the strong magnetic tape on the backside. It works well in a production area, e.g. for hanging up maintenance schedules on machines.</p>
<p><b>WS-WSF-02</b> Clipboard black magnetic with foil coating A4 format Weight: 140 g</p>	<p>Price in CHF 1 pc. 4.25 ea.</p>	<p>This black clipboard (coated with foil) can be attached to ferrous surfaces thanks to the two embedded neodymium magnets on the backside. It works great in a production area, e.g. to hang up maintenance plans on machines.</p>
<p><b>WS-WSF-03</b> Clipboard black with plastic coating and transparent pocket A4 format not magnetic! Weight: 140 g</p>	<p>Price in CHF 1 pc. 3.65 ea.</p>	<p>Practical clipboard with black foil coating and sheet protector on the backside. Thanks to the suspension eye, it can be hung up on the wall if necessary.</p>
<p><b>M-32</b> Rubber tape self-adhesive increases adhesive force in shear direction 10 x 5 cm Weight: 1.5 g</p>	<p>Price in CHF 1 pc. 2.65 ea. from 3 pcs. 2.40 ea. from 10 pcs. 2.10 ea. from 20 pcs. 2.00 ea. from 40 pcs. 1.90 ea.</p>	<p>This tape can prevent a magnet from sliding down. The silicone rubber tape increases the sticking friction between magnet and surface and thereby counteracts the diminished adhesive force in shear direction.</p>
<p><b>WS-BIT-01</b> Bitpass magnetic bit holder for wrist or cordless screwdriver including 6 bits Weight: 32 g</p>	<p>Price in CHF 1 pc. 19.95 ea.</p>	<p>Bitpass is a magnetic bit holder for quick bit exchanges (screwdriver bits). Included in the delivery are 6 bits (1x TX 15, 1x TX 20, 1x TX 25, 1x TX 30, 1x PZ 2, 1x PH 2).</p>
<p><b>MCS-1208</b> Storage case mini made of sturdy plastic, with foam insert 208 x 144 x 92 mm non-magnetic! Weight: 850 g</p>	<p>Price in CHF 1 pc. 45.00 ea.</p>	<p>In this plastic case you can store your magnets, but also tools and other objects. The content of the case is protected against dust and water. You can modify the included foam padding depending on the content you chose to store in there.</p>
<p><b>MCS-1233</b> Storage case mini deep made of sturdy plastic, with foam insert 270 x 246 x 174 mm non-magnetic! Weight: 1.4 kg</p>	<p>Price in CHF 1 pc. 54.00 ea.</p>	<p>In this plastic case you can store your magnets, but also tools and other objects. The content of the case is protected against dust and water. You can modify the included foam padding depending on the content you chose to store in there.</p>
<p><b>MCS-1300</b> Storage case medium made of sturdy plastic, with foam insert 339 x 295 x 152 mm non-magnetic! Weight: 1.8 kg</p>	<p>Price in CHF 1 pc. 89.00 ea.</p>	<p>In this plastic case you can store your magnets, but also tools and other objects. The content of the case is protected against dust and water. You can modify the included foam padding depending on the content you chose to store in there.</p>

## Magnets for campers – useful accessories for camper vans, motor homes & other

<p><b>BD-SILWY-1</b> silwy Bundle S bundle with 6x plastic silwy magnetic drinking cups assorted 6x metal-nano-gel-pads 1x silwy metal strip self- adhesive white Weight: 1.2 kg/set</p>	<p>Price in CHF 1 set 109.90/set</p>	<p>With the silwy self-adhesive metal strip, the assorted magnetic drinking cups in the silwy Bundle S can be stored upside down or horizontally to save space. Perfect for camping, motorhome, and boating trips.</p>
<p><b>CUP-01</b> silwy magnetic porcelain cups set of 2 2 magnetic cups made of porcelain 2 metal-nano-gel-pads black Weight: 800 g/set</p>	<p>Price in CHF 1 set 46.70/set</p>	<p>Set of 2 silwy magnetic porcelain cups to enjoy hot beverages during your camping or boating trip. The included metal-nano-gel-pads can be attached to any surface and are reusable.</p>
<p><b>CUP-02</b> silwy magnetic porcelain coffee mug to go 1 magnetic porcelain coffee mug 1 metal-nano-gel-pad black Weight: 800 g/set</p>	<p>Price in CHF 1 set 31.10/set</p>	<p>The silwy magnetic porcelain coffee mug to go is perfect when you are out and about or in the office. The included metal-nano-gel-pad protects against spills, is reusable and can be attached to any surface.</p>
<p><b>MCG-01</b> silwy magnetic crystal glasses, set of 2 wine 2 magnetic glasses made of crystal glass 2 metal-nano-gel-pads Weight: 850 g/set</p>	<p>Price in CHF 1 set 48.95/set from 3 sets 46.95/set from 5 sets 44.95/set</p>	<p>Set of 2 silwy magnetic crystal glasses to enjoy your wine in style. The metal-nano-gel-pad can be attached to any surface and is reusable. Perfect for your camping or sailing trip.</p>
<p><b>MCG-02</b> silwy magnetic crystal glasses, set of 2 champagne 2 magnetic glasses made of crystal glass 2 metal-nano-gel-pads Weight: 750 g/set</p>	<p>Price in CHF 1 set 48.95/set from 3 sets 46.95/set from 5 sets 44.95/set</p>	<p>Set of 2 magnetic crystal champagne glasses, 200 ml. Made of durable lightfast Tritan crystal glass. Very stable due to optimal magnetic force distribution in the glass bottom and metal-nano-gel-pad. Perfect for camping and boating trips.</p>
<p><b>MCG-03</b> silwy magnetic crystal glasses, set of 2 beer 2 magnetic glasses made of crystal glass 2 metal-nano-gel-pads Weight: 1 kg/set</p>	<p>Price in CHF 1 set 48.95/set from 3 sets 46.95/set from 5 sets 44.95/set</p>	<p>Set of 2 330 ml silwy magnetic crystal glasses to enjoy a beer when camping. Thanks to the magnet in the glass bottom, these glasses stick to the metal-nano-gel-pads even on tilted surfaces. The coasters are washable and reusable.</p>
<p><b>MCG-04</b> silwy magnetic crystal glasses, set of 2 long drink 2 magnetic glasses made of crystal glass 2 metal-nano-gel-pads Weight: 720 g/set</p>	<p>Price in CHF 1 set 48.95/set from 3 sets 46.95/set from 5 sets 44.95/set</p>	<p>Set of 2 silwy magnetic crystal glasses to enjoy long drinks while camping, 400 ml, clear. A magnet in the glass bottom lets the glasses adhere to the metal-nano-gel-pads, on most surfaces. The coasters are washable and reusable.</p>
<p><b>MCG-05</b> silwy magnetic crystal glasses, set of 2 whisky 2 magnetic glasses made of crystal glass 2 metal-nano-gel-pads Weight: 600 g/set</p>	<p>Price in CHF 1 set 48.95/set from 3 sets 46.95/set from 5 sets 44.95/set</p>	<p>Set of 2 silwy magnetic crystal whisky glasses 250 ml. Perfect for camping and boating trips. Made of durable BPA-free crystal glass. The magnet in the bottom lets them adhere to the metal-nano-gel-pads and allows for space-saving storage.</p>

<p><b>MDC-01</b> silwy lids for magnetic drinking glasses set of 2 with straw opening black Weight: 50 g/set</p>	<p>Price in CHF 1 set 10.95/set</p>	<p>Lid with straw opening, black. Fits the silwy drinking glasses. The lid closes the glass thanks to the vacuum effect, so the liquid remains in the glass in every position. The straw opening is closed and sealed when not in use.</p>
<p><b>MDC-02</b> silwy magnetic drinking cups set of 2 2 magnetic tumblers made of plastic 2 metal-nano-gel-pads in different colours Weight: 410 g/set</p>	<p>Price in CHF 1 set 29.95/set from 3 sets 27.95/set from 5 sets 25.95/set</p>	<p>A set of 2 silwy magnetic drinking cups made of Tritan™ plastic. Scratch-resistant, shatterproof and free of toxins. The metal-nano-gel-pad provides a secure base for these cups. Available in a variety of colours.</p>
<p><b>MDC-06</b> silwy magnetic drinking cups set of 6 6 magnetic tumblers made of plastic 6 metal-nano-gel-pads multicoloured Weight: 650 g/set</p>	<p>Price in CHF 1 set 76.95/set from 3 sets 72.95/set from 5 sets 70.95/set</p>	<p>A set of 6 silwy magnetic drinking cups made of Tritan™ plastic in blue, green, red, yellow, purple and grey, incl. 6 silwy metal-nano-gel-pads in black. Great for camping, boating or sailing trips.</p>
<p><b>MPG-01</b> silwy magnetic plastic glasses set of 2 wine clear 2 magnetic glasses made of plastic 2 metal-nano-gel-pads Weight: 690 g/set</p>	<p>Price in CHF 1 set 48.95/set from 3 sets 46.95/set from 5 sets 44.95/set</p>	<p>Set of 2 300 ml silwy magnetic plastic glasses to enjoy your wine when camping. Thanks to the magnet in the glass bottom, these glasses stick to the metal-nano-gel-pads even on tilted surfaces. The coasters are washable and reusable.</p>
<p><b>MPG-02</b> silwy magnetic plastic glasses set of 2 sparkling wine clear 2 magnetic glasses made of plastic 2 metal-nano-gel-pads Weight: 570 g/set</p>	<p>Price in CHF 1 set 48.95/set from 3 sets 46.95/set from 5 sets 44.95/set</p>	<p>Set of 2 150 ml silwy magnetic plastic sparkling wine glasses for camping and sailing trips. Thanks to the magnet in the glass bottom, these glasses stick to the metal-nano-gel-pads even on tilted surfaces. The coasters are washable and reusable.</p>
<p><b>MPG-03</b> silwy magnetic plastic glasses set of 2 beer clear 2 magnetic glasses made of plastic 2 metal-nano-gel-pads Weight: 700 g/set</p>	<p>Price in CHF 1 set 48.95/set from 3 sets 46.95/set from 5 sets 44.95/set</p>	<p>Set of 2 500 ml silwy magnetic plastic glasses to enjoy a beer when camping. Thanks to the magnet in the glass bottom, these glasses stick to the metal-nano-gel-pads even on tilted surfaces. The coasters are washable and reusable.</p>
<p><b>MPG-04</b> silwy magnetic plastic glasses set of 2 long drink clear 2 magnetic glasses made of plastic 2 metal-nano-gel-pads Weight: 720 g/set</p>	<p>Price in CHF 1 set 48.95/set from 3 sets 46.95/set from 5 sets 44.95/set</p>	<p>Set of 2 magnetic plastic glasses to enjoy long drinks when camping, 300 ml, clear. A magnet in the glass bottom lets the glasses adhere to the metal-nano-gel-pads, on most surfaces. The coasters are washable and reusable.</p>
<p><b>MPG-05</b> silwy magnetic plastic glasses set of 2 long drink grey 2 magnetic glasses made of plastic 2 metal-nano-gel-pads Weight: 720 g/set</p>	<p>Price in CHF 1 set 48.95/set from 3 sets 46.95/set from 5 sets 44.95/set</p>	<p>Set of 2 magnetic plastic glasses to enjoy long drinks when camping, 300 ml, grey. A magnet in the glass bottom lets the glasses adhere to the metal-nano-gel-pads, on most surfaces. The coasters are washable and reusable.</p>
<p><b>MPG-06</b> silwy magnetic plastic glasses set of 2 tumbler clear 2 magnetic glasses made of plastic 2 metal-nano-gel-pads Weight: 650 g/set</p>	<p>Price in CHF 1 set 48.95/set from 3 sets 46.95/set from 5 sets 44.95/set</p>	<p>Set of 2 silwy magnetic plastic tumblers 250 ml, clear. Perfect for camping and sailing trips. These glasses adhere to the metal-nano-gel-pads, thanks to the magnet in the glass bottom. The coasters are washable and reusable.</p>

<b>MPG-07</b> silwy magnetic plastic glasses set of 2 tumbler grey 2 magnetic glasses made of plastic 2 metal-nano-gel-pads Weight: 650 g/set		Price in CHF	Set of 2 silwy magnetic plastic tumblers 250 ml, grey. Perfect for camping and sailing trips. These glasses adhere to the metal-nano-gel-pads, thanks to the magnet in the glass bottom. The coasters are washable and reusable.
		1 set	48.95/set
	from	3 sets	46.95/set
	from	5 sets	44.95/set
<b>MPG-15</b> silwy magnetic plastic glasses set of 6 shot clear 6 magnetic glasses made of plastic 6 metal-nano-gel-pads Weight: 650 g/set		Price in CHF	Set of 6 silwy magnetic plastic shot glasses 40 ml. Perfect for camping and sailing trips. The glasses stick to the metal-nano-gel-pads thanks to the magnet in the glass bottom. The coasters are washable and reusable.
		1 set	69.95/set
	from	3 sets	66.95/set
	from	5 sets	65.50/set

## (Magnetic) car accessories

<p><b>LP-CHCARBIKE1L</b> Number plate holder 'Perfect Click' for bike carriers, landscape format magnetic number plate holder for number plates in landscape format 1 set for outfitting one bike carrier Weight: 1.8 kg/set</p>	<p>Price in CHF 1 set 91.45/set from 3 sets 85.75/set from 10 sets 80.65/set from 20 sets 78.20/set from 40 sets 76.00/set</p>	<p>Magnetic number plate holder 'Perfect Click' for bike carriers. Strong magnets securely hold the number plate, even at the car wash. Easily switch the number plates in a matter of seconds.</p>
<p><b>LP-SPARE-01</b> Holding plate front spare part number plate holder 'Perfect Click' Weight: 300 g</p>	<p>Price in CHF 1 pc. 30.45 ea.</p>	<p>Spare part for "Perfect Click" number plate holder LP-CHCAR1L and LP-CHCAR2H. Number plates on the front of the car are attached to it.</p>
<p><b>LP-SPARE-02</b> holding plate for portrait format back spare part number plate holder 'Perfect Click' Weight: 600 g</p>	<p>Price in CHF 1 pc. 47.00 ea.</p>	<p>Spare part for "Perfect Click" number plate holder LP-CHCAR2H. Number plates in portrait format on the back of the car are attached to it.</p>
<p><b>LP-SPARE-03</b> Holding plate for landscape format back spare part number plate holder 'Perfect Click' Weight: 600 g</p>	<p>Price in CHF 1 pc. 39.10 ea.</p>	<p>Spare part for "Perfect Click" number plate holder LP-CHCAR1L. Number plates in landscape format on the back of the care are attached to it.</p>
<p><b>LP-SPARE-04</b> number plate holder for portrait format back spare part number plate holder 'Perfect Click' made of aluminium black Weight: 500 g</p>	<p>Price in CHF 1 pc. 175.00 ea.</p>	<p>Spare part for "Perfect Click" number plate holder LP-CHCAR2H. Number plates in portrait format on the back of the care are attached to it.</p>
<p><b>LP-SPARE-05</b> Number plate holder for landscape format back spare part number plate holder 'Perfect Click' made of plastic black Weight: 500 g</p>	<p>Price in CHF 1 pc. 54.00 ea.</p>	<p>Spare part for "Perfect Click" number plate holder LP-CHCAR1L. Number plates in landscape format on the back of the care are attached to it.</p>
<p><b>LP-SPARE-06</b> Number plate holder front spare part number plate holder 'Perfect Click' made of plastic black Weight: 300 g</p>	<p>Price in CHF 1 pc. 34.00 ea.</p>	<p>Spare part for "Perfect Click" number plate holder LP-CHCAR1L. Number plates on the front of the car are attached to it.</p>
<p><b>LP-SPARE-07</b> Rubber buffer spare part number plate holder 'Perfect Click' set of 4 Weight: 4 g/set</p>	<p>Price in CHF 1 set 4.95/set</p>	<p>Spare part for "Perfect Click" number plate holders LP-CHCAR1L and LP-CHCAR2H, in a set of 4. The rubber puffers protect the autobody and are attached to the holding plates.</p>

<p><b>LP-SPARE-08</b> Spacer set spare part number plate holder 'Perfect Click' to lock in place the number plate Weight: 4 g/set</p>	<p>Price in CHF 1 set 4.95/set</p>	<p>Spare part for "Perfect Click" number plate holder LP-CHCAR1L and LP-CHCAR2H, in a set of 4. The spacers attach the mounting plate to the number plate holder.</p>
<p><b>M-89</b> Windscreen protection foil 2 in 1 sun &amp; frost protection all in one for magnetic attachment on the car Weight: 390 g</p>	<p>Price in CHF 1 pc. 14.95 ea.</p>	<p>This protective foil is an extremely practical windscreen cover in the summer and winter alike: It keeps your car cool in the summer and protects the windscreen from frost or snow in the winter.</p>
<p><b>M-VM-01</b> Magnetic mobile phone mount Car magnetic holder for mobile phones attaches to the air vent Weight: 50 g/set</p>	<p>Price in CHF 1 set 12.90/set</p>	<p>Diameter: 33 mm Height: 33 mm Accessories: Metal Plate (self-adhesive)</p>
<p><b>M-ALU-0304</b> Alunet shade cloth 80% S sun protection for car and garden 3 x 4 m Weight: 1.4 kg</p>	<p>Price in CHF 1 pc. 109.90 ea.</p>	<p>Aluminium mesh with UV-resistant coating. Reflects 80% of solar irradiation and protects from sun burn and heat.</p>
<p><b>M-ALU-0305</b> Alunet shade cloth 80% M sun protection for car and garden 3 x 5 m Weight: 1.8 kg</p>	<p>Price in CHF 1 pc. 139.90 ea.</p>	<p>Aluminium mesh with UV-resistant coating. Reflects 80% of solar irradiation and protects from sun burn and heat.</p>
<p><b>M-ALU-0306</b> Alunet shade cloth 80% L sun protection for car and garden 3 x 6 m Weight: 2.2 kg</p>	<p>Price in CHF 1 pc. 169.90 ea.</p>	<p>Aluminium mesh with UV-resistant coating. Reflects 80% of solar irradiation and protects from sun burn and heat.</p>
<p><b>M-ALU-0406</b> Alunet shade cloth 80% XL sun protection for car and garden 4 x 6 m Weight: 3 kg</p>	<p>Price in CHF 1 pc. 209.90 ea.</p>	<p>Aluminium mesh with UV-resistant coating. Reflects 80% of solar irradiation and protects from sun burn and heat.</p>
<p><b>M-PLATE-CH</b> CH decal for motor vehicles &amp; trailer magnetic Weight: 34 g</p>	<p>Price in CHF 1 pc. 4.95 ea.</p>	<p>A magnetic CH decal instead of a permanent sticker is very convenient: You can easily attach the country decal when needed and remove it when it is no longer required.</p>
<p><b>M-PLATE-L</b> L-plate for student driver vehicles magnetic learner plate Weight: 47 g</p>	<p>Price in CHF 1 pc. 4.95 ea.</p>	<p>The big advantage of a magnetic L plate: You can easily attach it during a learner drive and take it off when it's no longer needed.</p>

<b>LP-CHCAR1L</b> Number plate holder 'Perfect Click' landscape format magnetic number plate holder for number plates in landscape format 1 set for outfitting 2 cars Weight: 2.6 kg/set	Price in CHF 1 set 120.00/set	Top seller! "Perfect Click" is a magnetic number plate holder in landscape format. The integrated super magnets guarantee a secure hold. One set is sufficient for outfitting two cars.
<b>LP-CHCAR2H</b> Number plate holder 'Perfect Click' portrait format magnetic number plate holder for number plates in portrait format 1 set for outfitting 2 cars Weight: 2.4 kg/set	Price in CHF 1 set 295.00/set	We now also carry the magnetic "Perfect Click" holder for interchangeable number plates in portrait format. One set is sufficient for outfitting 2 cars.
<b>M-42</b> Fan fin country flag, holds approx. 15 kg magnetic flag for the car Weight: 120 g strength: approx. 15 kg	Price in CHF 1 pc. 14.95 ea.	With this original fan fin, you can show which team you are rooting for when you are "on the road".
<b>M-58</b> Fun fin, holds approx. 15 kg magnetic fun item for your car Weight: 120 g strength: approx. 15 kg	Price in CHF 1 pc. 19.95 ea.	You would like to pimp your car, for instance with a pirate flag or a "Just married" sign? Pick the original magnetic fun fin.

## Fishing magnets and accessories for successful magnet fishing

<p><b>BD-TR400-1</b> Fishing magnet 400 bundle magnet fishing bundle with 1 fishing magnet 400, adhesive force approx. 400 kg 1 locking carabiner 120 x 11 mm and 1 polypropylene rope 9 mm x 15 m Weight: 3.9 kg/set</p>	<p>Price in CHF 1 set 99.90/set</p>	<p>Bundle with rope, locking carabiner and fishing magnet with 400 kg adhesive force, magnetic on both sides. You will be ideally equipped with the strongest magnet in our assortment! Not a toy!</p>
<p><b>M-KH-120</b> Carabiner small 60 x 6 mm firefighter carabiner, galvanised holds 120 kg Weight: 26 g</p>	<p>Price in CHF 1 pc. 3.90 ea. from 5 pcs. 3.70 ea. from 10 pcs. 3.40 ea.</p>	<p>This small carabiner with a load capacity of 120 kg is very versatile. The galvanised surface inhibits the formation of rust, allowing both indoor and outdoor use of the carabiner.</p>
<p><b>M-KH-230S</b> Locking carabiner 80 x 8 mm firefighter carabiner, galvanised holds 230 kg Weight: 60 g</p>	<p>Price in CHF 1 pc. 5.95 ea. from 5 pcs. 5.50 ea. from 10 pcs. 4.95 ea.</p>	<p>Sturdy carabiner with screw lock and a load capacity of 230 kg. Perfect for magnet fishing as a connector piece between rope and eyebolt / ring nut.</p>
<p><b>M-KH-450S</b> Locking carabiner 120 x 11 mm firefighter carabiner, galvanised holds 450 kg Weight: 190 g</p>	<p>Price in CHF 1 pc. 10.90 ea. from 5 pcs. 9.90 ea. from 10 pcs. 8.90 ea.</p>	<p>Massive locking carabiner with a load capacity of 450 kg. The safety lock prevents an accidental opening of the carabiner.</p>
<p><b>M-MPB-1</b> Utility pouch two-way zipper with attachment loops Weight: 190 g</p>	<p>Price in CHF 1 pc. 9.95 ea.</p>	<p>Sturdy utility pouch with two-way zipper. Water-repellent inside and drainage eyelet in the bottom. Inside, elastic loop straps on both long sides. Outside, attachment loops with snap fasteners, MOLLE compatible.</p>
<p><b>M-MPB-2</b> Dump pouch 14 cm opening with attachment loops Weight: 180 g</p>	<p>Price in CHF 1 pc. 9.95 ea.</p>	<p>Sturdy dump pouch for outdoor activities. Large inner pocket with drawstring closure, 2 side pockets (one made of netting), one front pocket with hook and loop closure. 2 attachment loops with snap fasteners, MOLLE compatible.</p>
<p><b>M-ROPE-515</b> Polypropylene rope 5 mm x 15 m for magnet fishing not a climbing rope! Weight: 140 g</p>	<p>Price in CHF 1 pc. 4.95 ea.</p>	<p>This polypropylene rope is weather-resistant and durable. Ideal for magnet fishing, use around the house or garden and camping. Caution: Not suitable for climbing or lifting loads.</p>
<p><b>M-ROPE-560</b> Polypropylene rope 5 mm x 60 m for magnet fishing not a climbing rope! Weight: 670 g</p>	<p>Price in CHF 1 pc. 19.80 ea.</p>	<p>This polypropylene rope is weather-resistant and durable. Ideal for magnet fishing, use around the house or garden and camping. Caution: Not suitable for climbing or lifting loads.</p>



<p><b>M-ROPE-715</b> Polypropylene rope 7 mm x 15 m for magnet fishing not a climbing rope! Weight: 250 g</p>	<p>Price in CHF 1 pc. 9.95 ea.</p>	<p>This polypropylene rope is weather-resistant and durable. Ideal for magnet fishing, use around the house or garden and camping. Caution: Not suitable for climbing or lifting loads.</p>
<p><b>M-ROPE-760</b> Polypropylene rope 7 mm x 60 m for magnet fishing not a climbing rope! Weight: 1.1 kg</p>	<p>Price in CHF 1 pc. 39.80 ea.</p>	<p>This polypropylene rope is weather-resistant and durable. Ideal for magnet fishing, use around the house or garden and camping. Caution: Not suitable for climbing or lifting loads.</p>
<p><b>M-ROPE-915</b> Polypropylene rope 9 mm x 15 m for magnet fishing not a climbing rope! Weight: 360 g</p>	<p>Price in CHF 1 pc. 14.95 ea.</p>	<p>This polypropylene rope is weather-resistant and durable. Ideal for magnet fishing, use around the house or garden and camping. Caution: Not suitable for climbing or lifting loads.</p>
<p><b>M-ROPE-960</b> Polypropylene rope 9 mm x 60 m for magnet fishing not a climbing rope! Weight: 1.6 kg</p>	<p>Price in CHF 1 pc. 59.80 ea.</p>	<p>This polypropylene rope is weather-resistant and durable. Ideal for magnet fishing, use around the house or garden and camping. Caution: Not suitable for climbing or lifting loads.</p>
<p><b>M-TH-TR100</b> Fishing magnet 100 for magnet fishing, magnetic on both sides 2x M8 threads incl. matching eyebolt strength approx. 100 kg Weight: 480 g</p>	<p>Price in CHF 1 pc. 30.10 ea. from 3 pcs. 26.50 ea. from 10 pcs. 23.30 ea.</p>	<p>Double-sided fishing magnet. Thanks to the steel casing, both the underside and the top have an adhesive force of 100 kg. Included in the delivery: Fishing magnet and eyebolt M8. Not a toy!</p>
<p><b>M-TH-TR200</b> Fishing magnet 200 for magnet fishing, magnetic on both sides 2x M10 threads incl. matching eyebolt strength approx. 200 kg Weight: 1.1 kg</p>	<p>Price in CHF 1 pc. 41.15 ea. from 3 pcs. 36.35 ea. from 10 pcs. 32.05 ea.</p>	<p>Double-sided fishing magnet. Thanks to the steel casing, both the underside and the top have an adhesive force of 200 kg. Included in the delivery: Fishing magnet and eyebolt M10. Not a toy!</p>
<p><b>M-TH-TR400</b> Fishing magnet 400 for magnet fishing, magnetic on both sides 2x M12 threads incl. matching eyebolt strength approx. 400 kg, N35 Weight: 3.3 kg</p>	<p>Price in CHF 1 pc. 81.20 ea. from 3 pcs. 72.20 ea.</p>	<p>Fishing magnet with 400 kg adhesive force, magnetic on both sides. By far the strongest neodymium magnet in our assortment! Included in the delivery: Fishing magnet and eyebolt M12. Not a toy!</p>
<p><b>M-TH-D30</b> Treasure hunter magnet David 30, holds approx. 30 kg retrieving magnet for magnet fishing with 15 m nylon cord Weight: 300 g strength: approx. 30 kg</p>	<p>Price in CHF 1 pc. 35.95 ea.</p>	<p>Retrieving magnet David 30 with 30 kg adhesive force, incl. 15 m long nylon rope. Perfect for beginners to gain initial magnet fishing experience.</p>
<p><b>M-TH-D45</b> Treasure hunter magnet David 45, holds approx. 45 kg retrieving magnet for magnet fishing with eyebolt and 15 m nylon rope Weight: 680 g strength: approx. 45 kg</p>	<p>Price in CHF 1 pc. 49.95 ea.</p>	<p>The retrieval magnet David 45 with its 45 kg adhesive force is perfect for beginners. It comes with a 15 m long nylon rope that can be attached to the magnet. An eyebolt M8 is also included in the delivery.</p>

## Miscellaneous

Here you can find special magnets as well as magnet accessories.

<p><b>CYL-M4-10</b> Cylinder screw with hexagon socket M4 length 10 mm without shaft according to SN EN ISO 4762, not magnetic! Weight: 3 g</p>	<p>Price in CHF 10 pcs. 0.20 ea. from 500 pcs. 0.15 ea. from 1000 pcs. 0.10 ea.</p>	<p>These cylinder screws with a hexagon socket and M4 thread are made of rust-proof stainless steel and therefore very sturdy.</p>
<p><b>CYL-M5-10</b> Cylinder screw with hexagon socket M5 length 10 mm without shaft according to SN EN ISO 4762, not magnetic! Weight: 3 g</p>	<p>Price in CHF 10 pcs. 0.20 ea. from 500 pcs. 0.15 ea. from 1000 pcs. 0.10 ea.</p>	<p>These cylinder screws with a hexagon socket and M5 thread are made of rust-proof stainless steel and therefore very sturdy.</p>
<p><b>M-94</b> Test tube for decoration purposes not heat or fire resistant! Weight: 9 g</p>	<p>Price in CHF 1 pc. 1.45 ea.</p>	<p>Length: 160 mm Diameter: 16 mm Wall thickness: 0.5 mm Material: Soda-Lime glass</p>
<p><b>OSC-01</b> Washer made of anodised aluminium in different colours not magnetic! Weight: 2 g</p>	<p>Price in CHF 10 pcs. 1.50 ea. from 500 pcs. 1.25 ea. from 1000 pcs. 1.00 ea.</p>	<p>These washers made of coloured anodised aluminium are resistant to corrosion and therefore perfect for outdoor use.</p>
<p><b>OSC-02</b> Washer cone-shaped made of anodised aluminium in different colours not magnetic! Weight: 2 g</p>	<p>Price in CHF 10 pcs. 1.50 ea. from 500 pcs. 1.25 ea. from 1000 pcs. 1.00 ea.</p>	<p>These washers made of coloured anodised aluminium are resistant to corrosion and therefore perfect for outdoor use.</p>
<p><b>M-HOOK-32</b> Magnetic hook set with scratch protection, holds approx. 9 kg base covered with felt set of 4 Weight: 210 g/set strength: approx. 9 kg</p>	<p>Price in CHF 1 set 24.95/set from 3 sets 22.95/set from 10 sets 21.20/set from 20 sets 20.30/set from 40 sets 19.55/set</p>	<p>4 super-strong magnetic hooks for fastening the Alunet shade cloth on the car. The base of each magnet is coated in felt to avoid scratches on the vehicle.</p>
<p><b>M-82</b> Magnetic wall pins with screw and rawlplug for hanging up objects set of 5 Weight: 41 g/set</p>	<p>Price in CHF 1 set 5.55/set</p>	<p>Versatile wall pins with strong holding power, available in a set of 5. Includes screws and rawlplugs.</p>
<p><b>SM-SB-01</b> Shopping bag supermagnete.swiss made of plastic not magnetic! Weight: 73 g</p>	<p>Price in CHF 1 pc. 3.50 ea.</p>	<p>Synthetic supermagnete shopping bag. Made in Switzerland by our partner, the workshop Murghof.</p>

## Gift ideas: Magnetic articles for any budget

Here you can find magnetic gift items that are original and suitable for every budget.

<p><b>M-47</b> Beer tree large magnetic beer cap collector ideal party gift holds up to 120 bottle caps Weight: 150 g</p>	<p>Price in CHF 1 pc. 39.90 ea.</p>	<p>For the beer tree you don't need a green thumb, you just need to be thirsty, because with every bottled beer your tree will grow a little bit. The strong magnet on the top of the tree trunk can easily hold 120 bottle caps.</p>
<p><b>M-40</b> Wall bottle opener beer bottle opener with magnetic bottle cap collector incl. mounting accessories Weight: 470 g/set</p>	<p>Price in CHF 1 set 33.00/set</p>	<p>This magnetic bottle opener not only attracts everyone's attention - it also catches the falling bottle caps. It can collect up to 60 caps that form a cluster underneath the opener.</p>
<p><b>LIV-38</b> Decorative magnet 'Diamond Heart', holds approx. 450 g with heart motif, made of acrylic glass with Swarovski crystals Weight: 13 g strength: approx. 450 g</p>	<p>Price in CHF 1 pc. 25.90 ea. from 3 pcs. 23.85 ea. from 10 pcs. 22.05 ea.</p>	<p>The sparkling diamond heart is not only a head turner, it also holds on to love notes and other memos. Square.</p>
<p><b>LIV-90</b> Decorative magnet 'Red Heart', holds approx. 1.5 kg acrylic red heart with zircon incl. organza fabric pouch Weight: 8 g strength: approx. 1.5 kg</p>	<p>Price in CHF 1 pc. 5.49 ea.</p>	<p>Not just for Valentines Day! A red acrylic heart with a little sparkling zircon on the top right. On the backside there is a strong neodymium magnet 12 x 2 mm embedded to hold all those love notes. Each heart is packaged in a silver fabric bag and makes for a great gift.</p>
<p><b>FO-8</b> Magnetic board slate elegant and exclusive magnet noticeboard 40 x 20 cm incl. 10 strong magnets Weight: 2.2 kg</p>	<p>Price in CHF 1 pc. 40.00 ea.</p>	<p>Noble wall panel with blue-grey slate surface. 40 cm x 20 cm, made from slate from the Mosel river area, with character line (wall distance about 1 cm). Easy assembly, in portrait and landscape format. Every one of those pieces is unique.</p>
<p><b>LIV-40</b> Decorative magnet 'Diamond Star', holds approx. 450 g with star motif, made of acrylic glass with Swarovski crystals Weight: 13 g strength: approx. 450 g</p>	<p>Price in CHF 1 pc. 24.90 ea. from 3 pcs. 22.90 ea. from 10 pcs. 19.90 ea.</p>	<p>The star made of 250 sparkling Swarovski elements is not just for superstars but looks also nice on your refrigerator.</p>
<p><b>FRM-03</b> Magnetic picture frame 18 x 13 cm photo frame with magnetic catch made of transparent acrylic glass for portrait or landscape format Weight: 830 g</p>	<p>Price in CHF 1 pc. 27.40 ea.</p>	<p>The same picture frame as Magnetic picture frame 11.5 x 9 cm, but bigger and therefore suitable for pictures of up to 17.8 x 12.7 cm.</p>
<p><b>M-KNIFEB-002</b> Knife block magnetic Pentagon magnetic knife holder made of wood for 8 knives up to 900 g Weight: 1.8 kg</p>	<p>Price in CHF 1 pc. 86.50 ea.</p>	<p>Your knives seem to float on the "Pentagon". Thanks to the extremely strong embedded magnets, you can safely attach at least 8 knives with a weight of up to 900 g.</p>

<p><b>M-KNIFESET-001</b> Breakfast board set cutting board made of beechwood with magnetic knife holder &amp; PanoramaKnife Weight: 370 g/set</p>	<p>Price in CHF 1 set 99.95/set</p>	<p>The perfect set for a breakfast, snack, picnic or hiking break. Features a breakfast knife and a beechwood board with magnetic knife holder, original by PanaormaKnife Switzerland.</p>
<p><b>M-77</b> Hot food bag with cherry pit pad with magnetic catch in various designs Weight: 300 g</p>	<p>Price in CHF 1 pc. 29.95 ea.</p>	<p>These pretty hot food bags are made in a sheltered workshop in Switzerland and display classic Swiss motifs, such as the alpine cattle-drive and the famous edelweiss. With the practical magnetic catch you can conveniently close the bag.</p>
<p><b>Q-70-70-30-N</b> Block magnet 70 x 70 x 30 mm, holds approx. 150 kg Weight: 1.1 kg Nickel-plated (Ni-Cu-Ni) Magnetisation: N40 strength: approx. 150 kg</p>	<p>Price in CHF 1 pc. 111.35 ea. from 3 pcs. 102.40 ea. from 10 pcs. 94.40 ea. from 20 pcs. 90.50 ea. from 40 pcs. 87.05 ea.</p>	<p>After the MONOLITH, the GOLIATH is the second strongest magnet in our assortment. Due to its high adhesive force, the GOLIATH is a very dangerous magnet and not suitable for magnet novices. Please follow the enclosed safety tips.</p>
<p><b>Z-10</b> Macho set magnet set case with 40 super magnets Weight: 1.4 kg/set</p>	<p>Price in CHF 1 set 59.95/set</p>	<p>For people who aren't easily impressed, we now have the supermagnete macho set! 10 large and 30 small super magnets in one tool case.</p>
<p><b>MON-01</b> Monolux magnetic candle holder in a gift box Weight: 120 g</p>	<p>Price in CHF 1 pc. 24.95 ea.</p>	<p>The Monolux always finds a place - wherever you wish for cosiness. It stays wherever there is a magnetic surface! On the fridge, on a shelf, on the stair railing and even on a pin...</p>
<p><b>WS-BIT-01</b> Bitpass magnetic bit holder for wrist or cordless screwdriver including 6 bits Weight: 32 g</p>	<p>Price in CHF 1 pc. 19.95 ea.</p>	<p>Bitpass is a magnetic bit holder for quick bit exchanges (screwdriver bits). Included in the delivery are 6 bits (1x TX 15, 1x TX 20, 1x TX 25, 1x TX 30, 1x PZ 2, 1x PH 2).</p>
<p><b>M-43</b> Wooden magnet set 27 magnetic wooden cubes made of oiled oak wood Weight: 510 g/set</p>	<p>Price in CHF 1 set 64.95/set</p>	<p>Thanks to the embedded sphere magnets, the 27 wooden cubes are magnetic on all six sides, which allows for building various imaginative constructs.</p>
<p><b>LIV-123</b> MagNICI magnetic plush toys with sewn-in magnet in each paw Weight: 22 g</p>	<p>Price in CHF 1 pc. 9.90 ea.</p>	<p>Who doesn't like the legendary NICI plush toys? We have some running around in our supermagnete assortment - naturally with magnetic feet!</p>
<p><b>M-ZUB-02</b> Zubits® M magnetic shoe closures for youth &amp; adults in different colours Weight: 40 g/set</p>	<p>Price in CHF 1 set 21.45/set</p>	<p>Magnetic shoe closures for quick in and out of shoes. Secure hold, even when active.</p>

<p><b>MANI-01</b> Fridge magnets 'African animals' magnetic mini animals made from old tin cans sale profits go to Children's Aid Madagascar (Kinderhilfe Madagaskar) Weight: 30 g</p>	<p>Price in CHF 1 pc. 13.50 ea.</p>	<p>These magnetic animals are skilfully crafted in Madagascar from old tin cans. All sales proceeds benefit the children's aid organisation zaza malagasy in Madagascar.</p>
<p><b>LIV-47</b> Magnetic words words, syllables and punctuation marks 510 pieces available in various languages Weight: 290 g/set</p>	<p>Price in CHF 1 set 19.95/set</p>	<p>A set of magnetic words contains 510 pieces: Words, syllables and punctuation marks. Available in five languages: German, English, French, Dutch and Spanish</p>
<p><b>MCAR-01</b> Fridge magnets 'MadagasCAR' magnetic mini vehicles made of old tin cans sale profits go to Children's Aid Madagascar (Kinderhilfe Madagaskar) Weight: 30 g</p>	<p>Price in CHF 1 pc. 13.50 ea.</p>	<p>These beautiful little cars and planes are manufactured in Madagascar. Handy craftsmen make them with lots of love and creativity out of old tin cans. The entire proceeds from the sale of these little cars and planes go to the Children's Fund in Madagascar.</p>
<p><b>M-PUTTY-FERRO</b> Smart putty magnetic ferromagnetic putty different colours magnet not included Weight: 140 g</p>	<p>Price in CHF 1 pc. 13.45 ea.</p>	<p>The magnetic smart putty impresses with cool tricks and fascinating effects. As soon as a super magnet is nearby, the smart putty seems to come to life. Available in many colours.</p>
<p><b>M-PUTTY-GLITTER</b> Smart putty sparkling with glitter different colours not magnetic! Weight: 140 g</p>	<p>Price in CHF 1 pc. 13.45 ea.</p>	<p>Smart putty impresses with cool tricks and fascinating effects. Additional feature of the 'Glitter' type: It shimmers as if millions of stars were trapped inside!</p>
<p><b>M-PUTTY-GLOW</b> Smart putty Glow glows in the dark different colours not magnetic! Weight: 140 g</p>	<p>Price in CHF 1 pc. 12.95 ea.</p>	<p>Smart putty impresses with cool tricks and fascinating effects. The model "Glow" even glows in the dark.</p>
<p><b>FL-10</b> Photo rope 'Sweetheart' 1.5 m steel cable with loop and steel weight incl. 8 heart magnets Weight: 70 g</p>	<p>Price in CHF 1 pc. 14.90 ea. from 3 pcs. 13.40 ea. from 10 pcs. 12.05 ea. from 20 pcs. 11.40 ea. from 40 pcs. 10.85 ea.</p>	<p>1,5 m long photo rope with 8 cute and magnetic metal hearts. For the sweetest photos and cards!</p>
<p><b>LIV-95</b> Magnetic plush toys with sewn-in magnets in each front paw Weight: 20 g</p>	<p>Price in CHF 1 pc. 9.90 ea.</p>	<p>Thanks to the strong magnets inside, the friendly fluffy animals adhere to fridge or magnetic board. You can select from 10 different animal species.</p>
<p><b>LIV-119</b> Glass magnets lucky charm handmade fridge magnets set of 3 Weight: 18 g/set</p>	<p>Price in CHF 1 set 10.00/set</p>	<p>Pretty glass magnets with lucky charms. Handmade in Switzerland.</p>

<p><b>LIV-52</b> Sheep magnets, holds approx. 550 g fridge magnets shaped as sheep set of 6 Weight: 73 g/set strength: approx. 550 g</p>	<p>Price in CHF 1 set 9.90/set</p>	<p>Shepard wanted! This flock of sheep is looking for someone to take care of them. Who could resist these trusting eyes?</p>
<p><b>LIV-91</b> Decorative magnet 'Diamond Cat', holds approx. 1.5 kg white cat made of acrylic glass with Swarovski crystals Weight: 15 g strength: approx. 1.5 kg</p>	<p>Price in CHF 1 pc. 24.90 ea. from 3 pcs. 22.90 ea. from 10 pcs. 19.90 ea.</p>	<p>The white kitty sparkles thanks to white and coloured Swarovski crystals. Using the IMPLEXIONS technique, which is unique in the world, precious SWAROVSKI® crystals are embedded seamlessly and without bubbles in high-quality acrylic glass. The cat measures approx. 42 x 47 mm.</p>
<p><b>M-41</b> Tangram cube made of 24 magnetic tetrahedrons with 20 templates Weight: 590 g</p>	<p>Price in CHF 1 pc. 29.95 ea.</p>	<p>You need all your wits for this game! The Tangram cube consists of 24 magnetic plastic pyramids. With these tetrahedrons you can also build more challenging shapes and figures.</p>
<p><b>M-38</b> Letters or numbers magnetic set of magnetic symbols made of foam 4 assorted colours Weight: 350 g/set</p>	<p>Price in CHF 1 set 19.00/set</p>	<p>Each box of magnetic letters and numbers contains approx. 100 foam symbols, which contain a magnetic sheet on the back that makes them adhere to metal surfaces, such as blackboards and whiteboards and even magnetic paint.</p>
<p><b>LIV-111</b> Building block magnets 'Classic' with press-fitted magnets assorted set of 14 Weight: 27 g/set</p>	<p>Price in CHF 1 set 11.00/set</p>	<p>Coloured bricks in seven bright colours with pressed-in neodymium magnets.</p>

## Magnet bestsellers

You are not sure which magnets to buy from our huge assortment? You can't do no wrong with these magnets! They are the absolute bestsellers of recent years because they are extremely versatile and have a great price-performance ratio.

We aim to have plenty of these important articles in stock.

<p><b>M-FERROTAPE</b> Metal tape self-adhesive white 35 mm self-adhesive surface for magnets rolls of 1 m / 5 m / 25 m Weight: 75 g/m</p>	<p>Price in CHF</p> <p>1 m 5.59/m</p> <p>from 5 m 3.86/m</p> <p>from 25 m 2.81/m</p>	<p>Metal tape with self-adhesive cushioning on the back. The strip can be cut with normal scissors to the desired length, since it is only 0.15 mm thick. It also adheres to textured walls and is easy to install around corners.</p>
<p><b>Q-51-51-25-N</b> Block magnet 50.8 x 50.8 x 25.4 mm, holds approx. 100 kg Weight: 500 g Nickel-plated (Ni-Cu-Ni) Magnetisation: N40 strength: approx. 100 kg</p>	<p>Price in CHF</p> <p>1 pc. 54.90 ea.</p> <p>from 3 pcs. 49.70 ea.</p> <p>from 10 pcs. 45.05 ea.</p> <p>from 20 pcs. 42.80 ea.</p> <p>from 40 pcs. 40.80 ea.</p>	<p>We call this magnet THE DEATH MAGNET. I have no idea what you can reasonably do with this magnet - it is simply too intense for most applications. BE CAREFUL!!!</p>
<p><b>M-PIN</b> Magnetic pins 'Player', holds approx. 1.6 kg bulletin board magnets in the shape of a pawn in a game, Ø 12.5 mm set of 10 in different colours Weight: 28 g/set strength: approx. 1.6 kg</p>	<p>Price in CHF</p> <p>1 set 11.85/set</p> <p>from 3 sets 10.25/set</p> <p>from 10 sets 8.80/set</p> <p>from 30 sets 8.05/set</p>	<p>Very strong magnetic pin with practical knob. Holds ten A4 sheets of paper with no problem. In various colours. Set of 10 pins.</p>
<p><b>MS-A4-STIC</b> Self-adhesive magnetic sheet to cut &amp; glue A4 format grey-black Weight: 230 g</p>	<p>Price in CHF</p> <p>1 pc. 3.45 ea.</p> <p>from 3 pcs. 3.00 ea.</p> <p>from 10 pcs. 2.55 ea.</p> <p>from 20 pcs. 2.35 ea.</p> <p>from 40 pcs. 2.20 ea.</p>	<p>The A4 magnetic sheet with self-adhesive side can be cut to the desired size and lends itself to hanging up larger objects that require an increased adhesive force.</p>
<p><b>MS-A4</b> Coloured magnetic sheet for labelling and arts &amp; crafts A4 format in different colours Weight: 230 g</p>	<p>Price in CHF</p> <p>1 pc. 3.35 ea.</p> <p>from 3 pcs. 2.90 ea.</p> <p>from 10 pcs. 2.50 ea.</p> <p>from 20 pcs. 2.30 ea.</p> <p>from 40 pcs. 2.15 ea.</p>	<p>For labelling, arts &amp; crafts, marking - the only limit is your imagination. The A4 magnetic sheets are available in 13 different colours. The sheet is 1 mm thick and you can cut it and write on it.</p>
<p><b>MT-20-STIC</b> Magnetic adhesive tape ferrite 20 mm self-adhesive magnetic tape rolls of 1 m / 5 m / 25 m Weight: 110 g/m</p>	<p>Price in CHF</p> <p>1 m 2.49/m</p> <p>from 5 m 1.99/m</p> <p>from 25 m 1.62/m</p> <p>from 50 m 1.49/m</p> <p>from 75 m 1.42/m</p>	<p>The self-adhesive magnetic tape MT-20-STIC can attach non-magnetic objects to metal surfaces. This magnetic tape is 20 mm wide and available in lengths of 1 m, 5 m and 25 m.</p>
<p><b>MT-DISP</b> Magnetic adhesive tape for photos 5 m in dispenser Weight: 150 g</p>	<p>Price in CHF</p> <p>1 pc. 4.50 ea.</p> <p>from 3 pcs. 3.90 ea.</p> <p>from 10 pcs. 3.30 ea.</p> <p>from 20 pcs. 3.05 ea.</p> <p>from 40 pcs. 2.80 ea.</p>	<p>The tape that is both adhesive and magnetic. It attaches photos, postcards and other lightweight things easily and quickly to ferromagnetic surfaces, without making holes.</p>
<p><b>WS-ADH-01</b> UHU MAX REPAIR magnet glue, waterproof, without solvents shelf life of 24 months 20 g tube Weight: 20 g</p>	<p>Price in CHF</p> <p>1 pc. 7.95 ea. (397.50/kg)</p>	<p>Do you need a reliable adhesive for your super magnet application? We can recommend this adhesive with conviction. Suitable to use on wood, fabric, leather, cork, metal, glass, plastic, rubber, ceramic, stone or cement.</p>

<p><b>LIV-79</b> Magnetic clips 'Graffa' XL magnetic paper clamps with very high adhesive force set of 2 Weight: 70 g/set</p>	<p>Price in CHF 1 set 13.90/set</p>	<p>Two strong magnetic clips that adhere to any metal surface. You can attach calendars, recipes or magazines to always have them handy. Thanks to the non-slip coating, these clips stay in place even with heavy objects on them.</p>
<p><b>M-PUTTY-FERRO</b> Smart putty magnetic ferromagnetic putty different colours magnet not included Weight: 140 g</p>	<p>Price in CHF 1 pc. 13.45 ea.</p>	<p>The magnetic smart putty impresses with cool tricks and fascinating effects. As soon as a super magnet is nearby, the smart putty seems to come to life. Available in many colours.</p>
<p><b>LP-CHCAR1L</b> Number plate holder 'Perfect Click' landscape format magnetic number plate holder for number plates in landscape format 1 set for outfitting 2 cars Weight: 2.6 kg/set</p>	<p>Price in CHF 1 set 120.00/set</p>	<p>Top seller! "Perfect Click" is a magnetic number plate holder in landscape format. The integrated super magnets guarantee a secure hold. One set is sufficient for outfitting two cars.</p>
<p><b>FTN-32</b> Hook magnet Ø 32 mm, holds approx. 30 kg Thread M5 Weight: 52 g strength: approx. 30 kg</p>	<p>Price in CHF 1 pc. 4.25 ea. from 3 pcs. 3.75 ea. from 10 pcs. 3.30 ea. from 20 pcs. 3.05 ea. from 40 pcs. 2.85 ea.</p>	<p>Pot diameter D: 32 mm Neck diameter d: 10 mm Pot height H1: 7 mm Total height without hook H2: 15.5 mm with hook H3: 45 mm</p>
<p><b>CSN-13</b> Pot magnet Ø 13 mm with countersunk hole, holds approx. 3 kg Weight: 3 g strength: approx. 3 kg</p>	<p>Price in CHF 5 pcs. 1.31 ea. from 15 pcs. 1.13 ea. from 40 pcs. 1.00 ea. from 80 pcs. 0.91 ea.</p>	<p>Diameter D: 13 mm Total height H: 4.5 mm Hole d1: 3 mm Hole d2: 5.5 mm Countersinking t: 1.25 mm Tolerance: +/- 0.1 mm</p>
<p><b>CSN-16</b> Pot magnet Ø 16 mm with countersunk hole, holds approx. 4 kg Weight: 5 g strength: approx. 4 kg</p>	<p>Price in CHF 5 pcs. 1.59 ea. from 15 pcs. 1.39 ea. from 40 pcs. 1.23 ea. from 80 pcs. 1.14 ea.</p>	<p>Diameter D: 16 mm Total height H: 4.5 mm Hole d1: 3.5 mm Hole d2: 7.22 mm Countersinking t: 1.86 mm Tolerance: +/- 0.1 mm</p>
<p><b>CSN-ES-16</b> Pot magnet Ø 16 mm with countersunk hole, holds approx. 6.9 kg Weight: 5.5 g strength: approx. 6.9 kg</p>	<p>Price in CHF 5 pcs. 1.55 ea. from 15 pcs. 1.35 ea. from 40 pcs. 1.20 ea. from 80 pcs. 1.11 ea.</p>	<p>Similar dimensions as CSN-16, but with a thicker steel pot. Hence higher adhesive force than CSN-16.</p>
<p><b>CSN-20</b> Pot magnet Ø 20 mm with countersunk hole, holds approx. 8.9 kg Weight: 11 g strength: approx. 8.9 kg</p>	<p>Price in CHF 1 pc. 2.60 ea. from 3 pcs. 2.25 ea. from 10 pcs. 1.95 ea. from 20 pcs. 1.80 ea. from 40 pcs. 1.70 ea.</p>	<p>Diameter D: 20 mm Total height H: 6 mm Hole d1: 4.5 mm Hole d2: 9.46 mm Countersinking t: 2.48 mm Tolerance: +/- 0.1 mm</p>
<p><b>CSN-ES-20</b> Pot magnet Ø 20 mm with countersunk hole, holds approx. 11 kg Weight: 12 g strength: approx. 11 kg</p>	<p>Price in CHF 1 pc. 2.65 ea. from 3 pcs. 2.30 ea. from 10 pcs. 2.00 ea. from 20 pcs. 1.85 ea. from 40 pcs. 1.70 ea.</p>	<p>Similar dimensions as CSN-20, but with a thicker steel pot. Hence higher adhesive force than CSN-20.</p>



<p><b>CSN-25</b> Pot magnet Ø 25 mm with countersunk hole, holds approx. 19 kg Weight: 20 g strength: approx. 19 kg</p>	<p>Price in CHF</p> <p>1 pc. 3.65 ea. from 3 pcs. 3.20 ea. from 10 pcs. 2.80 ea. from 20 pcs. 2.60 ea. from 40 pcs. 2.45 ea.</p>	<p>Diameter D: 25 mm Total height H: 7 mm Hole d1: 5.5 mm Hole d2: 11.7 mm Countersinking t: 3.1 mm Tolerance: +/- 0.1 mm</p>
<p><b>CSN-32</b> Pot magnet Ø 32 mm with countersunk hole, holds approx. 30 kg Weight: 35 g strength: approx. 30 kg</p>	<p>Price in CHF</p> <p>1 pc. 5.60 ea. from 3 pcs. 5.00 ea. from 10 pcs. 4.45 ea. from 20 pcs. 4.20 ea. from 40 pcs. 3.95 ea.</p>	<p>Diameter D: 32 mm Total height H: 7 mm Hole d1: 5.5 mm Hole d2: 11.7 mm Countersinking t: 3.1 mm Tolerance: +/- 0.1 mm</p>
<p><b>GTN-25</b> Pot magnet Ø 25 mm with threaded stud, holds approx. 25 kg Thread M5 Weight: 27 g strength: approx. 25 kg</p>	<p>Price in CHF</p> <p>1 pc. 3.35 ea. from 3 pcs. 2.95 ea. from 10 pcs. 2.55 ea. from 20 pcs. 2.40 ea. from 40 pcs. 2.20 ea.</p>	<p>Pot diameter D: 25 mm Pot height H1: 8 mm Total height H2: 16.5 mm Tolerance: +/- 0.1 mm Coating: Nickel-plated (Ni-Cu-Ni) Max. working temperature: 80°C</p>
<p><b>K-05-N</b> Sphere magnet Ø 5 mm, holds approx. 300 g Weight: 0.5 g Nickel-plated (Ni-Cu-Ni) Magnetisation: N35 strength: approx. 300 g</p>	<p>Price in CHF</p> <p>20 pcs. 0.21 ea. from 60 pcs. 0.19 ea. from 140 pcs. 0.17 ea. from 360 pcs. 0.16 ea.</p>	<p>Nickel-coated small sphere magnets for endless combining and experimenting. Available in units of 10. ATTENTION: Not suitable for children under 14!</p>
<p><b>S-02-01-N</b> Disc magnet Ø 2 mm, height 1 mm, holds approx. 110 g Weight: 0.024 g Nickel-plated (Ni-Cu-Ni) Magnetisation: N48 strength: approx. 110 g</p>	<p>Price in CHF</p> <p>20 pcs. 0.19 ea. from 60 pcs. 0.16 ea. from 140 pcs. 0.14 ea. from 360 pcs. 0.12 ea.</p>	<p>Bestseller: More than 2 million sold!</p>
<p><b>S-04-02-N</b> Disc magnet Ø 4 mm, height 2 mm, holds approx. 420 g Weight: 0.19 g Nickel-plated (Ni-Cu-Ni) Magnetisation: N45 strength: approx. 420 g</p>	<p>Price in CHF</p> <p>20 pcs. 0.23 ea. from 60 pcs. 0.19 ea. from 140 pcs. 0.17 ea. from 360 pcs. 0.15 ea.</p>	<p>Bestseller: More than 7 million sold!</p>
<p><b>S-05-03-N</b> Disc magnet Ø 5 mm, height 3 mm, holds approx. 700 g Weight: 0.45 g Nickel-plated (Ni-Cu-Ni) Magnetisation: N42 strength: approx. 700 g</p>	<p>Price in CHF</p> <p>10 pcs. 0.30 ea. from 40 pcs. 0.24 ea. from 80 pcs. 0.22 ea. from 160 pcs. 0.20 ea.</p>	<p>More than 5.6 million sold</p>
<p><b>S-05-05-N</b> Disc magnet Ø 5 mm, height 5 mm, holds approx. 940 g Weight: 0.75 g Nickel-plated (Ni-Cu-Ni) Magnetisation: N45 strength: approx. 940 g</p>	<p>Price in CHF</p> <p>10 pcs. 0.36 ea. from 40 pcs. 0.30 ea. from 80 pcs. 0.27 ea. from 160 pcs. 0.25 ea.</p>	<p>Even this small magnet, which weighs less than 1 gramme, is able to attract another magnet through a human finger.</p>
<p><b>S-05-08-N</b> Rod magnet Ø 5 mm, height 8.47 mm, holds approx. 1.1 kg Weight: 1.3 g Nickel-plated (Ni-Cu-Ni) Magnetisation: N45 strength: approx. 1.1 kg</p>	<p>Price in CHF</p> <p>10 pcs. 0.45 ea. from 40 pcs. 0.37 ea. from 80 pcs. 0.34 ea. from 160 pcs. 0.31 ea.</p>	<p>Very small, strong rod magnet. This magnet is especially suitable as a fridge magnet, for use on a magnetic board, or on a magnetic strip. It has an enormous adhesive force and is also comfortable to hold.</p>

<p><b>S-08-02-N</b> Disc magnet Ø 8 mm, height 2 mm, holds approx. 1.1 kg Weight: 0.76 g Nickel-plated (Ni-Cu-Ni) Magnetisation: N45 strength: approx. 1.1 kg</p>	<p>Price in CHF</p> <p>10 pcs. 0.36 ea. from 40 pcs. 0.29 ea. from 80 pcs. 0.27 ea. from 160 pcs. 0.24 ea.</p>	<p>A small flat neodymium magnet with an adhesive force of about 1 kg. Our customers use it, for instance, for magnetic buttons or manual training in school.</p>
<p><b>S-08-03-N</b> Disc magnet Ø 8 mm, height 3 mm, holds approx. 1.5 kg Weight: 1.1 g Nickel-plated (Ni-Cu-Ni) Magnetisation: N45 strength: approx. 1.5 kg</p>	<p>Price in CHF</p> <p>10 pcs. 0.42 ea. from 40 pcs. 0.35 ea. from 80 pcs. 0.32 ea. from 160 pcs. 0.29 ea.</p>	<p>A good size for various craft projects, name tags at weddings, small refrigerator magnets, hanging-up posters...</p>
<p><b>S-08-08-N</b> Disc magnet Ø 8 mm, height 8 mm, holds approx. 2.5 kg Weight: 3.1 g Nickel-plated (Ni-Cu-Ni) Magnetisation: N45 strength: approx. 2.5 kg</p>	<p>Price in CHF</p> <p>5 pcs. 0.73 ea. from 15 pcs. 0.64 ea. from 40 pcs. 0.58 ea. from 80 pcs. 0.54 ea.</p>	<p>This disc magnet works well on magnetic glass boards.</p>
<p><b>S-08-0.75-STIC</b> Disc magnet self-adhesive Ø 8 mm, height 0.75 mm, holds approx. 320 g Weight: 0.29 g Nickel-plated (Ni-Cu-Ni) Magnetisation: N35 strength: approx. 320 g Adhesive: 3M, No. 467MP Shelf life adhesive: 12 months (approx.) Path additional document: 3M_200MP_Adhesive_Family_TDS_2017.pdf Label additional document: Adhesive data sheet</p>	<p>Price in CHF</p> <p>20 pcs. 0.23 ea. from 60 pcs. 0.20 ea. from 140 pcs. 0.18 ea. from 360 pcs. 0.16 ea.</p>	<p>No more annoying holes in your designer clothing: S-08-0.75-STIC holds name tags elegantly and without safety pins.</p>
<p><b>S-10-01-STIC</b> Disc magnet self-adhesive Ø 10 mm, height 1 mm, holds approx. 540 g Weight: 0.6 g Nickel-plated (Ni-Cu-Ni) Magnetisation: N35 strength: approx. 540 g Adhesive: 3M, No. 467MP Shelf life adhesive: 12 months (approx.) Path additional document: 3M_200MP_Adhesive_Family_TDS_2017.pdf Label additional document: Adhesive data sheet</p>	<p>Price in CHF</p> <p>20 pcs. 0.28 ea. from 60 pcs. 0.25 ea. from 140 pcs. 0.22 ea. from 360 pcs. 0.20 ea.</p>	<p>The convenient solution if you want to glue on the S-10-01-N. This is a flat disc magnet with a self-adhesive side. Just peel off the film and glue it on. One sales unit contains 10 magnetic pairs that attract each other.</p>
<p><b>S-10-02-N</b> Disc magnet Ø 10 mm, height 2 mm, holds approx. 1.3 kg Weight: 1.2 g Nickel-plated (Ni-Cu-Ni) Magnetisation: N42 strength: approx. 1.3 kg</p>	<p>Price in CHF</p> <p>10 pcs. 0.44 ea. from 40 pcs. 0.37 ea. from 80 pcs. 0.34 ea. from 160 pcs. 0.31 ea.</p>	<p>An adhesive force of about 1 kg with a 10 mm diameter and a 2 mm thickness make this disc magnet a top seller. It might be because you can embed it nicely.</p>
<p><b>S-10-03-N</b> Disc magnet Ø 10 mm, height 3 mm, holds approx. 1.8 kg Weight: 1.8 g Nickel-plated (Ni-Cu-Ni) Magnetisation: N42 strength: approx. 1.8 kg</p>	<p>Price in CHF</p> <p>10 pcs. 0.49 ea. from 40 pcs. 0.41 ea. from 80 pcs. 0.37 ea. from 160 pcs. 0.34 ea.</p>	<p>This reasonably priced magnet is wonderfully suitable for various craft projects. If you, for example, glue it to glass beads, you will have a very strong refrigerator or whiteboard magnet that can easily hold 15 pieces of A4 paper!</p>
<p><b>S-10-05-N</b> Disc magnet Ø 10 mm, height 5 mm, holds approx. 2.6 kg Weight: 3 g Nickel-plated (Ni-Cu-Ni) Magnetisation: N42 strength: approx. 2.6 kg</p>	<p>Price in CHF</p> <p>5 pcs. 0.69 ea. from 15 pcs. 0.60 ea. from 40 pcs. 0.53 ea. from 80 pcs. 0.49 ea.</p>	<p>These handy all-purpose magnets are so nicely-sized and so strong for such an unbelievable price that there will be no excuse for finding yourself without them in an emergency. :-)</p>
<p><b>S-10-10-N</b> Disc magnet Ø 10 mm, height 10 mm, holds approx. 3.9 kg Weight: 6 g Nickel-plated (Ni-Cu-Ni) Magnetisation: N45 strength: approx. 3.9 kg</p>	<p>Price in CHF</p> <p>5 pcs. 1.18 ea. from 15 pcs. 1.05 ea. from 40 pcs. 0.95 ea. from 80 pcs. 0.90 ea.</p>	<p>In between disc magnet and rod magnet. With almost 4 kg adhesive force extremely strong for its size. Great price-performance ratio.</p>

<p><b>S-15-03-N</b> Disc magnet Ø 15 mm, height 3 mm, holds approx. 3.2 kg Weight: 4 g Nickel-plated (Ni-Cu-Ni) Magnetisation: N45 strength: approx. 3.2 kg</p>	<p>Price in CHF</p> <table> <tr><td>5 pcs.</td><td>0.93 ea.</td></tr> <tr><td>from 15 pcs.</td><td>0.82 ea.</td></tr> <tr><td>from 40 pcs.</td><td>0.74 ea.</td></tr> <tr><td>from 80 pcs.</td><td>0.68 ea.</td></tr> </table>	5 pcs.	0.93 ea.	from 15 pcs.	0.82 ea.	from 40 pcs.	0.74 ea.	from 80 pcs.	0.68 ea.	<p>Top seller! For this disc magnet with its adhesive force of approx. 3 kg, normal whiteboard and magnetic board applications do not present a real challenge. This magnet is simply created for a higher purpose and it favours a heavier burden.</p>		
5 pcs.	0.93 ea.											
from 15 pcs.	0.82 ea.											
from 40 pcs.	0.74 ea.											
from 80 pcs.	0.68 ea.											
<p><b>S-15-08-N</b> Disc magnet Ø 15 mm, height 8 mm, holds approx. 6.2 kg Weight: 11 g Nickel-plated (Ni-Cu-Ni) Magnetisation: N42 strength: approx. 6.2 kg</p>	<p>Price in CHF</p> <table> <tr><td>1 pc.</td><td>1.95 ea.</td></tr> <tr><td>from 3 pcs.</td><td>1.75 ea.</td></tr> <tr><td>from 10 pcs.</td><td>1.50 ea.</td></tr> <tr><td>from 20 pcs.</td><td>1.40 ea.</td></tr> <tr><td>from 40 pcs.</td><td>1.35 ea.</td></tr> </table>	1 pc.	1.95 ea.	from 3 pcs.	1.75 ea.	from 10 pcs.	1.50 ea.	from 20 pcs.	1.40 ea.	from 40 pcs.	1.35 ea.	<p>A good in-between size! Not so painfully big, but definitely impressively strong. This magnet can hold 35 sheets of A4 paper on a metal cabinet. If this one is not going to be a big hit, I'll go get another job.</p>
1 pc.	1.95 ea.											
from 3 pcs.	1.75 ea.											
from 10 pcs.	1.50 ea.											
from 20 pcs.	1.40 ea.											
from 40 pcs.	1.35 ea.											
<p><b>S-20-02-N</b> Disc magnet Ø 20 mm, height 2 mm, holds approx. 2.9 kg Weight: 4.8 g Nickel-plated (Ni-Cu-Ni) Magnetisation: N45 strength: approx. 2.9 kg</p>	<p>Price in CHF</p> <table> <tr><td>5 pcs.</td><td>1.05 ea.</td></tr> <tr><td>from 15 pcs.</td><td>0.93 ea.</td></tr> <tr><td>from 40 pcs.</td><td>0.84 ea.</td></tr> <tr><td>from 80 pcs.</td><td>0.78 ea.</td></tr> </table>	5 pcs.	1.05 ea.	from 15 pcs.	0.93 ea.	from 40 pcs.	0.84 ea.	from 80 pcs.	0.78 ea.	<p>An extremely flat disc magnet with an adhesive force of 2 kg. Affordable and discreet - one of our bestsellers! Perfect for closures and fasteners of all kind.</p>		
5 pcs.	1.05 ea.											
from 15 pcs.	0.93 ea.											
from 40 pcs.	0.84 ea.											
from 80 pcs.	0.78 ea.											
<p><b>S-20-02-FOAM</b> Disc magnet self-adhesive Ø 20 mm, height 2 mm, holds approx. 2.3 kg Weight: 4.8 g Nickel-plated (Ni-Cu-Ni) Magnetisation: N35 strength: approx. 2.3 kg Adhesive: 3M, No. 4920, 0.40 mm Shelf life adhesive: 18 months (approx.) Path additional document: data_sheet_3m_4920.pdf Label additional document: Adhesive data sheet</p>	<p>Price in CHF</p> <table> <tr><td>10 pcs.</td><td>0.91 ea.</td></tr> <tr><td>from 40 pcs.</td><td>0.79 ea.</td></tr> <tr><td>from 80 pcs.</td><td>0.74 ea.</td></tr> <tr><td>from 160 pcs.</td><td>0.70 ea.</td></tr> </table>	10 pcs.	0.91 ea.	from 40 pcs.	0.79 ea.	from 80 pcs.	0.74 ea.	from 160 pcs.	0.70 ea.	<p>The convenient solution if you want to glue on the magnet S-20-02-N. This is a flat disc magnet with a self-adhesive side made of cushion foam. Just remove the foil and glue it on. One sales unit contains 5 magnet pairs.</p>		
10 pcs.	0.91 ea.											
from 40 pcs.	0.79 ea.											
from 80 pcs.	0.74 ea.											
from 160 pcs.	0.70 ea.											
<p><b>S-20-05-N</b> Disc magnet Ø 20 mm, height 5 mm, holds approx. 6.4 kg Weight: 12 g Nickel-plated (Ni-Cu-Ni) Magnetisation: N42 strength: approx. 6.4 kg</p>	<p>Price in CHF</p> <table> <tr><td>1 pc.</td><td>2.15 ea.</td></tr> <tr><td>from 3 pcs.</td><td>1.90 ea.</td></tr> <tr><td>from 10 pcs.</td><td>1.70 ea.</td></tr> <tr><td>from 20 pcs.</td><td>1.55 ea.</td></tr> <tr><td>from 40 pcs.</td><td>1.45 ea.</td></tr> </table>	1 pc.	2.15 ea.	from 3 pcs.	1.90 ea.	from 10 pcs.	1.70 ea.	from 20 pcs.	1.55 ea.	from 40 pcs.	1.45 ea.	<p>If you have to keep an eye on the thickness, for example, embedding a magnet in a cabinet door, then this 5 mm thin magnet is just the thing... and it still has an impressive attractive force!</p>
1 pc.	2.15 ea.											
from 3 pcs.	1.90 ea.											
from 10 pcs.	1.70 ea.											
from 20 pcs.	1.55 ea.											
from 40 pcs.	1.45 ea.											
<p><b>S-20-10-N</b> Disc magnet Ø 20 mm, height 10 mm, holds approx. 11 kg Weight: 24 g Nickel-plated (Ni-Cu-Ni) Magnetisation: N42 strength: approx. 11 kg</p>	<p>Price in CHF</p> <table> <tr><td>1 pc.</td><td>4.10 ea.</td></tr> <tr><td>from 3 pcs.</td><td>3.60 ea.</td></tr> <tr><td>from 10 pcs.</td><td>3.20 ea.</td></tr> <tr><td>from 20 pcs.</td><td>3.00 ea.</td></tr> <tr><td>from 40 pcs.</td><td>2.80 ea.</td></tr> </table>	1 pc.	4.10 ea.	from 3 pcs.	3.60 ea.	from 10 pcs.	3.20 ea.	from 20 pcs.	3.00 ea.	from 40 pcs.	2.80 ea.	<p>Wow! With this item you definitely get the most bang for your buck! Hard core! And a very good value (such prices are almost indecent).</p>
1 pc.	4.10 ea.											
from 3 pcs.	3.60 ea.											
from 10 pcs.	3.20 ea.											
from 20 pcs.	3.00 ea.											
from 40 pcs.	2.80 ea.											
<p><b>W-05-N</b> Cube magnet 5 mm, holds approx. 1.1 kg Weight: 0.95 g Nickel-plated (Ni-Cu-Ni) Magnetisation: N42 strength: approx. 1.1 kg</p>	<p>Price in CHF</p> <table> <tr><td>10 pcs.</td><td>0.39 ea.</td></tr> <tr><td>from 40 pcs.</td><td>0.32 ea.</td></tr> <tr><td>from 80 pcs.</td><td>0.30 ea.</td></tr> <tr><td>from 160 pcs.</td><td>0.27 ea.</td></tr> </table>	10 pcs.	0.39 ea.	from 40 pcs.	0.32 ea.	from 80 pcs.	0.30 ea.	from 160 pcs.	0.27 ea.	<p>A small cube magnet with 5 mm edge length. Its adhesive force of 1 kg is astounding for such a small magnet. A perfect and extremely discreet fridge or whiteboard magnet - one of our top sellers for good reason.</p>		
10 pcs.	0.39 ea.											
from 40 pcs.	0.32 ea.											
from 80 pcs.	0.30 ea.											
from 160 pcs.	0.27 ea.											
<p><b>W-10-N</b> Cube magnet 10 mm, holds approx. 3.8 kg Weight: 7.6 g Nickel-plated (Ni-Cu-Ni) Magnetisation: N42 strength: approx. 3.8 kg Colour: Silver-coloured</p>	<p>Price in CHF</p> <table> <tr><td>1 pc.</td><td>1.90 ea.</td></tr> <tr><td>from 3 pcs.</td><td>1.65 ea.</td></tr> <tr><td>from 10 pcs.</td><td>1.45 ea.</td></tr> <tr><td>from 20 pcs.</td><td>1.35 ea.</td></tr> <tr><td>from 40 pcs.</td><td>1.25 ea.</td></tr> </table>	1 pc.	1.90 ea.	from 3 pcs.	1.65 ea.	from 10 pcs.	1.45 ea.	from 20 pcs.	1.35 ea.	from 40 pcs.	1.25 ea.	<p>Cube-shaped magnets are somewhat unusual. These are strong enough to attract each other through the thickness of a hand. It takes a bit of determination to separate two of these magnets from each other.</p>
1 pc.	1.90 ea.											
from 3 pcs.	1.65 ea.											
from 10 pcs.	1.45 ea.											
from 20 pcs.	1.35 ea.											
from 40 pcs.	1.25 ea.											
<p><b>Q-10-10-1.2-N52N</b> Block magnet 10 x 10 x 1.2 mm, holds approx. 1 kg Weight: 0.91 g Nickel-plated (Ni-Cu-Ni) Magnetisation: N52 strength: approx. 1 kg</p>	<p>Price in CHF</p> <table> <tr><td>10 pcs.</td><td>0.54 ea.</td></tr> <tr><td>from 40 pcs.</td><td>0.44 ea.</td></tr> <tr><td>from 80 pcs.</td><td>0.40 ea.</td></tr> <tr><td>from 160 pcs.</td><td>0.37 ea.</td></tr> </table>	10 pcs.	0.54 ea.	from 40 pcs.	0.44 ea.	from 80 pcs.	0.40 ea.	from 160 pcs.	0.37 ea.	<p>Thanks to its extremely strong N52 magnetisation, this very flat block magnet has an adhesive force of 1 kg.</p>		
10 pcs.	0.54 ea.											
from 40 pcs.	0.44 ea.											
from 80 pcs.	0.40 ea.											
from 160 pcs.	0.37 ea.											

<b>Q-40-10-05-N</b> Block magnet 40 x 10 x 5 mm, holds approx. 9.5 kg Weight: 15 g Nickel-plated (Ni-Cu-Ni) Magnetisation: N42 strength: approx. 9.5 kg	Price in CHF 1 pc. 3.30 ea. from 3 pcs. 2.95 ea. from 10 pcs. 2.60 ea. from 20 pcs. 2.40 ea. from 40 pcs. 2.25 ea.	A slim, but very strong block magnet. Very popular in the areas of interior fittings, machine construction and cabinetmaking.
<b>Q-40-10-10-N</b> Block magnet 40 x 10 x 10 mm, holds approx. 15 kg Weight: 30 g Nickel-plated (Ni-Cu-Ni) Magnetisation: N42 strength: approx. 15 kg	Price in CHF 1 pc. 5.30 ea. from 3 pcs. 4.70 ea. from 10 pcs. 4.15 ea. from 20 pcs. 3.85 ea. from 40 pcs. 3.65 ea.	A very slim block magnet with an adhesive force of impressive 15 kg. Our customers build it into lamps or wood/metal furniture.

## % SALE %: Strong magnets & magnetic products at bargain prices

Here is your chance at a bargain! The listed articles are on clearance at very reduced prices. The availability can change rapidly - check the online shop for current information.

<b>SALE-096</b> Bottle cap magnets fridge magnets set of 4 Weight: 72 g/set	Price in CHF 1 set 4.95/set	Love, spelled out, in modern bottle cap magnets. And of course super-strong thanks to a neodymium magnet on the backside!
<b>SALE-089</b> Fridge magnets 'Little rabbit' rabbit-shaped set of 4 Weight: 55 g/set	Price in CHF 1 set 4.95/set	Not just at Easter, but a cute eye-catcher on the fridge all year round.
<b>SALE-090</b> Fridge magnets 'Honey' bear-shaped set of 4 Weight: 27 g/set	Price in CHF 1 set 4.95/set	So sweet you would want to bite into them! Unfortunately, the honey bears are not made of sugar, but they last longer.
<b>SALE-095</b> Glass magnets 'Bouquet' with flower motifs set of 4 Weight: 100 g/set	Price in CHF 1 set 4.95/set	Cute glass magnets with French vintage flower motifs in bright colours.
<b>SALE-094</b> Glass magnets 'Summer' with summer motifs set of 4 Weight: 100 g/set	Price in CHF 1 set 4.95/set	Finally summer! At least when you have these pretty and happy summer-themed glass magnets on your fridge!
<b>SALE-092</b> Glass magnets 'Jardin' with garden motifs set of 4 Weight: 100 g/set	Price in CHF 1 set 4.95/set	For all garden enthusiasts we have beautiful vintage magnets in many different green themes.
<b>SALE-093</b> Glass magnets 'America' with American motifs set of 4 Weight: 100 g/set	Price in CHF 1 set 4.95/set	Glass magnets with classic American vintage motifs in stylish muted brown and blue shades.
<b>SALE-105</b> Fridge magnets 'Beetle in Glass' antiqued look set of 2 Weight: 62 g/set	Price in CHF 1 set 4.95/set	Beetle magnets made of hand-painted tin in trendy vintage look.

<b>SALE-106</b> Dog magnets made of plastic, velvety set of 5 Weight: 30 g/set	Price in CHF 1 set 4.95/set	Original dog magnets in pastel colours that highlight everything on a magnetic board.
<b>ANI-02</b> Piggy magnetic memo holder Pig Weight: 63 g	Price in CHF 1 pc. 3.90 ea.	Piglet Piggy looks at the world with the stoicism and calmness of a zen master, despite its not very diversified function as a memo holder. Get inspired!
<b>SALE-107</b> Teddy magnets made of plastic, velvety set of 4 Weight: 30 g/set	Price in CHF 1 set 4.95/set	Original bear magnets in bright colours that are the highlights on any magnetic board.
<b>SALE-115</b> Metal hooks self-adhesive round, blue set of 4 not magnets! Weight: 52 g/set	Price in CHF 1 set 3.90/set	Elegant round metal hooks with strong 3M adhesive on the backside adhere securely to smooth surfaces. You receive four round blue hooks.



## Questions about our online shop

**Can I buy your products in a store?**

**No, we do not maintain a physical store. Our products are distributed exclusively through our online shop [<https://www.supermagnete.ch/eng/>].**

You can get a good overview of our magnet assortment not only in our online shop but also with our PDF catalogue [<https://www.supermagnete.ch/eng/downloads>]. Should you have any questions or need advice, please contact our customer service [<https://www.supermagnete.ch/eng/contact>].



## Delivery Terms (Switzerland)

Delivery Terms of Other Countries: <https://www.supermagnete.ch/eng/eng/conditions/other>

### Shipment

The shipment is carbon offset and will be handled by the Swiss postal service. Bulk /general cargo will be delivered by our logistics partner Lamprecht or its partner companies.

### Shipping Costs

- PostPac Economy: 6.90 CHF  
When orders are received on a business day before 12:00 o'clock, the delivery occurs on the same day, otherwise the following business day.  
Delivery time: 2 business days.  
There is no package delivery on Saturday.
- PostPac Priority: 8.90 CHF  
When orders are received on a business day before 12:00 o'clock, the delivery occurs on the same day, otherwise the following business day.  
Delivery time: 1 business day.  
There is no package delivery on Saturday.
- Swiss-Express Moon: Will be calculated during ordering process  
When orders are received on a business day before 14:00 o'clock, the delivery occurs on the same day, otherwise the following business day.  
Delivery occurs by 9 o'clock the day after shipping.  
Packages will also be delivered on Saturdays.

### VAT

All shop prices include Swiss VAT.

### Payment

- Prepayment to our account in Switzerland  
We will send you our account details via e-mail with the order confirmation. As soon as we receive your payment, we will ship you the merchandise.
- Invoice  
We will send you an invoice and a pay-in slip with the delivery. The invoice amount is payable without deductions within 14 days (private customers) or 30 days (business customers). We reserve the right to request pre-payment when it comes to first-time or large-value orders. We will then send you an invoice for pre-payment. This will also be enforced in case of larger outstanding balances. In certain cases, for justifiable reasons, such as a credit check, to reduce credit and default risks, to combat abuse or collect outstanding bills, we transmit your data to a credit information institute and receive the necessary data from the providers. Please note our data privacy statement.
- Credit/debit card (MasterCard, VISA, American Express)

You pay your order free of charge directly via your TWINT account. In order to be able to use this payment method, you need to be registered with TWINT and have the mobile app installed. After you ordered, you can confirm the payment with your TWINT mobile app.

- PayPal

You pay your order via Apple Pay. This payment option will only appear if you have already set up

Apple Pay.

- Google Pay

The PCI DSS certificate attests that supermagnete.ch meets the high security requirements of the payment card industry.

Default of paymentIf a customer does not fulfil their payment obligation in full or in part, Webcraft AG can suspend further product deliveries to this customer.For a second demand note, Webcraft AG can collect 20.00 CHF as reimbursement for expenses. After unsuccessful demand notes, the invoice amounts can be assigned to a debt collection agency, which enforces the outstanding amounts in their name and at their own expense and can collect additional administrative fees.

### **Minimum order**

The minimum order amount is CHF 20.00 (including VAT, not including shipping costs).

### **Return policy**

Customers from Switzerland and Liechtenstein may return products within 14 days of receipt. You may not return custom-made orders.

## Contact

### **Our Mailing Address (not a store!):**

[supermagnete.ch](http://supermagnete.ch)

Webcraft AG

Weiherallee 11a

8610 Uster

Switzerland

Tel. +41 43 399 03 59

[support@supermagnete.ch](mailto:support@supermagnete.ch)